

OPERATION MANUAL

BURST - GENERATOR

EFT4-4



OPERATION MANUAL

BURST – GENERATOR

EFT4-4

Warning:

This apparatus generates high voltages which may cause danger to life for persons with a cardiac pacemaker. This is for persons with cardiac pacemaker unavoidable dangerous equipment. The local and national and all applicable safety regulations must be obeyed for operation of this unit.

Operation of this unit is only allowed to an experienced electric technician (see VDE 0104) respectively through qualified operating personal (electro technical instructed person).

Before using the generator please read this manual and also the warnings to the safety points under chapter 1

Contents

1	SECURITY INSTRUCTIONS.....	4
2	OVERVIEW	5
3	BURST-DEFINITION ACC. TO IEC/EN 61000-4-4.....	5
4	DESCRIPTION OF FUNCTIONS	6
4.1	GENERAL	6
4.2	FRONT PANEL FUNCTIONS	7
4.3	CONNECTORS ON THE REAR	7
4.4	FUNCTIONS-DISPLAY (TOUCH).....	8
5	PUTTING INTO OPERATION	9
6	TESTING	9
6.1	TEST IN CONFORMITY TO THE STANDARDS / POWER LINES	9
6.1.1	<i>General.....</i>	9
6.1.2	<i>Quick setting by means of memory function.....</i>	9
6.1.3	<i>Operation modes.....</i>	10
6.2	TEST ACCORDING TO THE STANDARD / DATA-LINES	11
6.3	VARIABLE TESTING / PARAMETERS FREE ADJUSTABLE	11
6.4	POLARITY SELECTION	12
6.5	COUPLING NETWORK	12
6.5.1	<i>Coupling</i>	12
6.5.2	<i>Information regarding EUT supply.....</i>	13
6.6	PULSE OUTPUT	13
6.7	DUT MONITORING WITH EUT FAIL.....	13
6.8	PULSE CHECK AND MEASUREMENTS	14
6.8.1	<i>Monitor output.....</i>	14
6.8.2	<i>Output High Voltage.....</i>	14
6.9	SPECIAL FUNCTIONS	15
6.9.1	<i>Special function Continuous Burst.....</i>	16
6.9.2	<i>Special function IFM / Increasing Frequency mode.....</i>	16
6.9.3	<i>Special function DFM / Decreasing Frequency mode.....</i>	17
6.9.4	<i>Special function Real Burst Mode.....</i>	18
6.9.5	<i>Special function Sweep Burst Mode</i>	19
6.10	MEMORY-FUNCTION.....	20
6.10.1	<i>General description</i>	20
6.10.2	<i>Examples on the usage of the memory key.....</i>	20
7	TEST PROCEDURE	21
8	LIMITS OF PARAMETERS.....	21
9	TECHNICAL DATA	22
9.1	GENERATOR UNIT.....	22
9.2	COUPLING NETWORK	22
9.3	GENERAL	22
10	CALIBRATION	23
11	SCOPE OF DELIVERY	23
12	ACCESSORIES (OPTIONALLY)	23
13	BLOCK SCHEMATIC EFT4-4.....	24
14	ADDRESS OF THE MANUFACTURER:	24

1 **Security instructions**

Attention !

The device generates high voltages.

The device may only be operated on compliant earthed socket outlets. Disconnecting the earthing contact connection is not permitted. The housing and the grounding sockets are connected to the protective conductor of the network.

If the device has external damage and safe operation is no longer possible, the device must be taken out of operation and secured against unauthorized use.

In the case of a fault, high voltages can also occur inside the device, even with disconnected power supplies (built in capacitors). Service work should therefore only be carried out by specialists who are familiar with the device.

Due to its specification, the EFT4-4 is only approved for laboratory use in an industrial environment.

The coupling/decoupling network (CDN) has no internal fuses. The user must ensure that the device under test and the coupling/decoupling network are protected in accordance with the DUT current consumption. The maximum protection may not exceed 16 A - see also technical data.

Operation with capacitive coupling clamp:

When operating a capacitive coupling clamp (for example EFT 415), care must be taken that no coupling path is activated and no supply voltage is present at the coupling network input [34].

Attention!

At the inputs of the coupling/decoupling network still dangerous pulse voltage occurs.

Therefore, since there is no contact protection at the Schuko plug, NEMA 5-15 (type B) plug or any other plug that may be used to feed power to the DUT/coupling network, it must always be ensured that the pulse voltage is only triggered when the power supply cable connected to feed the DUT / coupling/decoupling network (CDN) is securely connected to the power source.

Furthermore, the impulse release may only be activated when the absolute contact protection to the device under test (and any connected devices) is ensured.

2 Overview

The test generator EFT4-4 simulates fast transient disturbances as defined in various standards (see IEC 61000-4-4, EN 61000-4-4, DIN-EN 61000-4-4).

Such disturbances are mainly generated when switching inductive loads. Characteristic of these disturbances are the very short rise times (ns range) of the individual pulses and the high repetition rate within a burst packet (see Figure 1).

Each individual pulse thus generates a wide interference spectrum up to approx. 300 MHz. For line-bound interference due to the high frequency components is still an HF influence caused by the short antenna lengths.

By increasing the number of individual pulses within a burst packet and the resulting addition effect digital and analog circuits can be influenced.

The simple operation and clear arrangement of the device settings allow time-saving and optimized checks in the following areas:

- Research and design:
Test with fixed standard values and investigation with variable settings (search for worst case)
- Quality assurance:
Test with fixed standard values, manual adjustable or automatic test procedure by remote computer control.
- Service:
Handy and easy to be operated

3 Burst-definition acc. to IEC/EN 61000-4-4

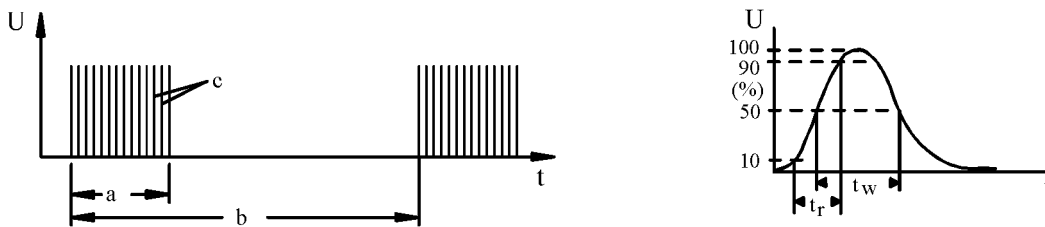

Figure1

Designation	Param.	Standard definition	Variable setup on EFT4-4
Burst duration	a	15 ms ± 20% at 5 kHz 0,75 ms ± 20% at 100 kHz (correspond to 75 pulses /package)	0,01 - 100 ms *1
Burst period	b	300 ms ± 20 %	10 - 1000 ms *1
Burst frequency	c	5 kHz or 100 kHz up to 4 kV	100 Hz - 125 kHz up to 5 kV
Pulse amplitude	U	0,5 / 1 / 2 / 4 kV	100 V - 5000 V (into 10 V steps) *2
Pulse rise-time	tr	5 ns ± 30 %	
Pulse width (50 Ohm)	tw	50 ns ± 30 %	
Pulse-width (1 kOhm)		50 ns, -15ns/+100 ns	
Impedance	Z	50 Ω ± 2 %	

*1: The values are automatically adjusted according to the boundary parameters (see chapter 8)

*2: Meets the standard from 200 Volt until 5000 Volt

4 Description of functions

4.1 General

The burst generator EFT4-4 exists of a generator module and a coupling network. The generator module itself has a power supply, a control module and a high voltage module.

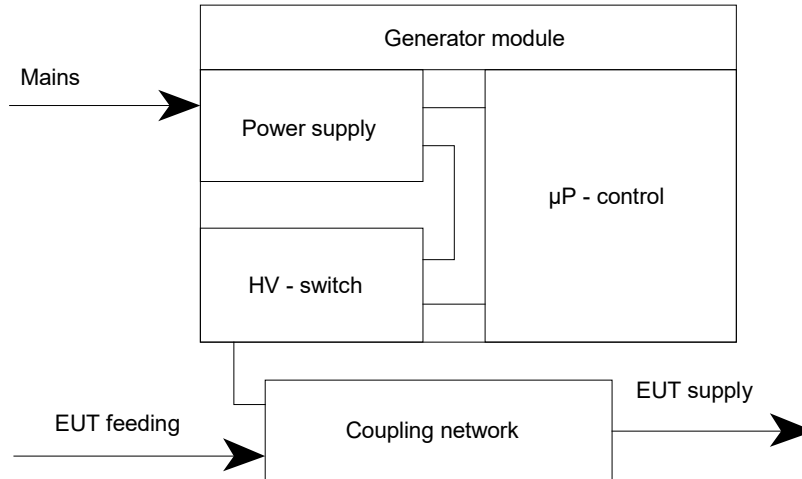

Figure2

4.2 Front panel functions



- [1] Ground jack.
- [2] Laboratory jacks for EUT connection.
- [3] Protected earth outlet for EUT connection.
- [4] Functions-Display (touch) – details see chapter4.4
- [5] Digital rotary encoder for adjusting the parameter values in the display [4].
- [6] External trigger release.
- [7] USB connection (optional optical interface for fiber optics) for remote control. ("PC" and "Next generator").
- [8] Indication for the phase orientation with a red and a green lamp.
- [9] Output to control the optional 3-phase coupling network SURGE 520 / 523 / 524
- [10] HV-output for the connection of a capacitive coupling clamp or an external 3 phase coupling network.

4.3 Connectors on the rear

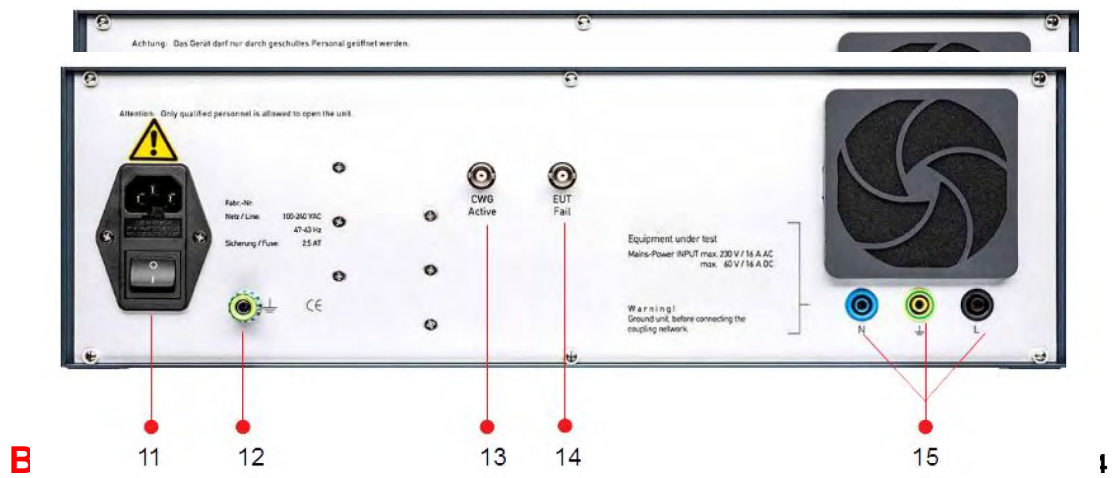

- [11] Electronic feeding for the EFT4-4 with RF-suppression filter.
- [12] Ground jack.
- [13] Internal serial bus for the operation of several Schloeder test generators in one setup
- [14] Operational input for a EUT's failure supervision.
- [15] Jacks for EUT-feeding

4.4 Functions-Display (Touch)

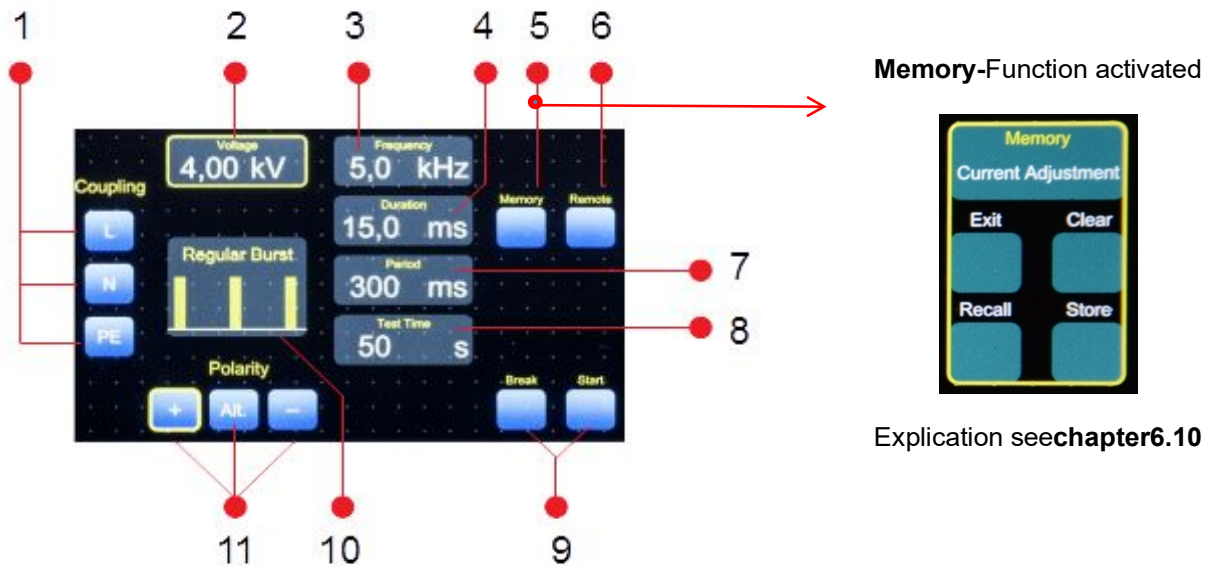
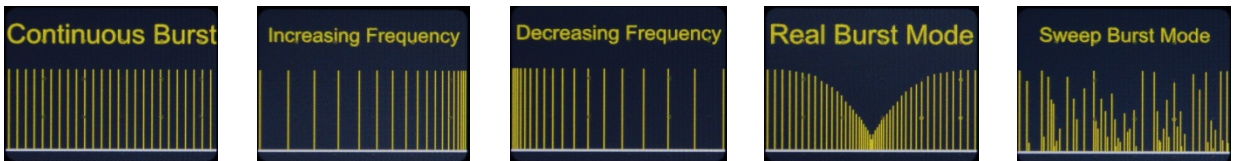

Figure5

- [1] **Coupling** selection for the paths L, N and PE
- [2] Burst **Voltage** selection is set with the rotary encoder [Front 5].
- [3] A Selection of the burst frequency **Frequency**, is set with rotary encoder [Front 5].
- [4] Selection of the packet length **Duration** is set with rotary encoder [Front 5].
- [5] Activation of the **Memory** function.
- [6] Activation of the interface-mode (**Remote** control or touch-panel control).
- [7] Selection of the repetition period **Period**, is set with rotary encoder [Front 5].
- [8] Selection of test duration **Test Time**, is set with rotary encoder [Front 5].
- [9] Trigger-start /-break
- [10] Selection of the special functions. The following functions are activated by repeated pressing:



- Continuous Burst: packet length corresponds with the test time, see chapter 8.
- Increasing Frequency: increasing burst frequency in one packet with set pulse-voltage.
- Decreasing Frequency: decreasing burst frequency in one packet with set pulse-voltage.
- Real Burst Mode: decreasing burst frequency, same time increasing the pulse-voltage.
- Sweep Burst Mode: randomized frequency and voltage variation in one package.

- [11] **Polarity** of Burstpacket: + (positive),- (negative) or**Alt.** (alternating).

The following Parameters can be changed in different speeds with the rotary encoder [Front 5]. With dashed marking, these are adjusted in larger steps.

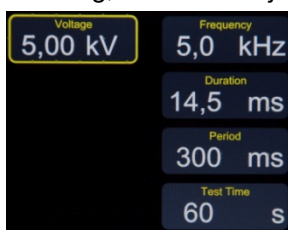

1x touch



double touch> larger steps

5 Putting into operation

1. Provide mains connection for the generators power supply, use power connector on the rear of the generator (widerange power supply).
2. Provide additional ground connection on one of the ground connectors on the rear or front side of the unit. Ground connectors are marked with the ground sign.
3. Connect the cable for the test objects supply to the 3 connectors on the unit's rear side, first the 3 safety-connectors, then the protection-earth power plug. At DC-applications can used appropriate laboratory cables.
4. At 230 V AC applications the power plug must be in a position that the green lamp [Front 8] is on. This ensures that the phase is connected to the connector [L].
5. Connect the test object to the earthed power outlet or the laboratory jacks.
6. Switch the mains switch on the rear on. (Ready for operation after about 2 seconds. The generator checks internally the high voltage and the temperature-controlled fan)

Make the following settings in the touch display:

7. Select the desired operation mode with the memory pad [5] or use the variable mode to set the desired parameters (see chapter 4.4).
8. Select desired polarity with the touch pad [11], positive [+], negative [-] or alternating [Alt.].
9. Select the desired coupling with touch pads [1].
10. Pressing the touch pad Start [9]. After pressing the key the interference pulses are superposed according to the adjusted coupling and the other parameters to the mains of the EUT.
11. To stop the burst test the Break-key [9] must be pressed

6 Testing

6.1 Test in conformity to the standards / power lines

6.1.1 General

The basic standard for interference-immunity-tests is given in IEC 61000-4-4 and EN 61000-4-4. Contents of the mentioned standards are identical.

6.1.2 Quick setting by means of memory function

For the test according to the standard IEC 61000-4-4, the respective test parameters have already been stored in the device memory. These predefinitions are accessed via the memory button [5] in the touch display (see Figure 5).

A short press on this button activates the following touch panel:



The rotary encoder [Front 5] is used to select the memory locations

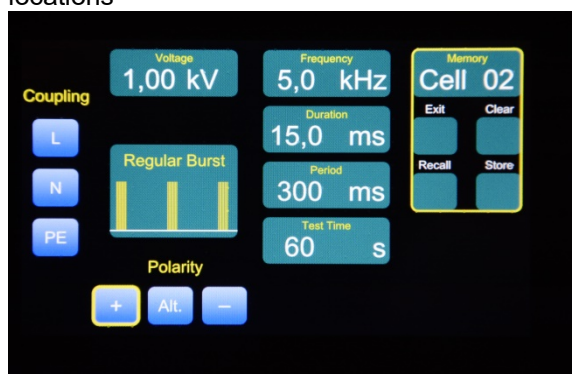

The memory locations 01 to 04 (**Cell 1 ...Cell 4**) are provided for the test levels 1 – 4 (Burst-frequency 5 kHz) and the memory locations 05 to 08 (**Cell 5 ...Cell 8**) are provided for the test levels 1 – 4 (Burst-frequency 100 kHz). With the key **Recall** the corresponding storage space is taken over. More detailed description of the memory function you find in chapter **6.10**

In the four displays **Voltage** [Touch 2], **Frequency** [Touch 3], **Duration** [Touch 4] and **Period** [Touch 7] the parameters according to IEC 61000-4-4 appear as following:

cell	voltage	frequency	duration	period
1 (5)	500 V	5 kHz (100 kHz)	15 ms (0,75 ms)	300 ms
2 (6)	1000 V	5 kHz (100 kHz)	15 ms (0,75 ms)	300 ms
3 (7)	2000 V	5 kHz (100 kHz)	15 ms (0,75 ms)	300 ms
4 (8)	4000 V	5 kHz (100 kHz)	15 ms (0,75 ms)	300 ms

After the touch switch [Touch 1] has been activated and the polarity [Touch 11] has been defined, the test can be triggered by pressing "**Start**" [Touch 9] key.

6.1.3 Operation modes

6.1.3.1 Single event

- Activation via **Test Time** Button [Touch 8] followed by turning the rotary encoder [Front 5] to the left until the display shows **Single**.
- When pressing the **Start** button [Touch 9], only one burst packet is output.

6.1.3.2 Continuous operation

- Activation with **Test Time** button [8] followed by turning the rotary encoder to the right [Front 5] until the display shows **Permanent**. The test time starts with **Start** [9] and is only terminated with **Stop** [9].

6.1.3.3 Automatic Mode:

- At Automatic mode a **Test Time** is defined.
- The triggering occurs by pressing the **Start** button [Touch 9] and ends after the **Test Time** has elapsed.
- The **Test Time** [8] display shows the time setting (before the start button is pressed) or the current remaining time of the burst test, also in case the **Break** button has been pressed.
- With **Break** [Touch 9] the test is interrupted, the **Test Time** [Touch 8] is stopped and the display flashes **Continue**.
- With **Stop** the test procedure can be aborted. In this case, **Test Time** again displays the originally set test time.

6.1.3.4 Extern release:

The function of the **Start** key [9] may be remote controlled via BNC-input [Front 6]: permanent grounding of this TTL-input makes continuous operation. Short time (less than burst period) grounding fires a single burst packet.

6.1.3.5 Time accurate triggering

To detect failures, it is possible to couple the burst signal very exactly into the EUT - at an exact process time point. The times are very precisely adhered to - in a μ s range.

The first Burst pulse starts after the falling flank by the external trigger signal. The basic delay is 1 ms with a jitter of less than $\pm 0,1 \mu$ s up to 100 kHz.

6.2 Test according to the standard / data-lines

The tests on data- and signal-lines with a capacitive coupling clamp are defined in the standard IEC 61000-4-4 and EN 61000-4-4. The pulse-voltage is divided by two - referred to the pulse-voltage at mains-coupling. So the test levels 1 - 4 are defined with the voltages 250V, 500V, 1000V and 2000V.

When the pulse is released, the interference signal is fed to the jack [10] where the capacitive coupling clamp (EFT 415) is connected via the high-voltage cable EFT 430. **The coupling selection keys [1] have to be switched off** so the interference signal is effective without any impair.

The lines to be tested are placed between the coupling-plates of the coupling clamp EFT 415 and the hood is closed. This is the only possibility to test according to the standard. A touch with the coupling plate (at a open hood at EFT 415-1) with the hand would cause a capacitive decoupling against to ground via the human body. The test result will unwanted improved.

6.3 Variable testing / parameters free adjustable

The adjustment of the test parameters is done by pressing the key referring to the display of the desired parameter and turning the digital rotary encoder [5].

NOTE: Pressing the Select button and turning the Rotary encoder simultaneously increases the increment steps in the display.

The parameters should be adjusted in a certain sequence: **Voltage, Frequency, Duration, Period, TestTime.**

This makes sure that no adjustments have to be repeated because of the automatic correction incase the maximum parameters combination is exceeded (the Generator EFT4-4 automatically considers the maximum generator's power capability, see also chapter 8).

Important!

All parameters can be changed during a test. It is not necessary to interrupt the test.

Voltage: [Touch 2]

- Adjustable from 100 V to 5000 V, displayed in kV.
- This voltage can be varied in 10V-steps.

Frequency: [Touch 3]

- Variable setting possible from 0,1 kHz up to 125 kHz.

Duration: [Touch 4]

- Setting possible from 0,01 ms to 100 ms.
Depending on the **Frequency** and the **Duration**, the Generator EFT4-4 automatically considers the maximum generator's power capability (see chapter 8).
The display is off if mode **Continuous** is activated.

Period: [Touch 7]

- Range of setting from 10 ms to 1000 ms.
Depending on the **Frequency** and the **Duration**, the Generator EFT4-4 automatically considers the maximum generator's power capability (see chapter 8).

Test time: [Touch 8]

- Setup from Single Event up to 9990 sec. or **Permanent**.

6.4 Polarity selection

The polarity of the generated pulses can be selected by using the keys [Touch 11]:

Positive

Key "+" is pressed, key "Alt" not pressed.

The burst packets, dependant from the present parameters, will be generated with positive sign.

Negative

Key "-" is pressed, key "Alt" not pressed.

The burst packets will be generated with negative sign.

Alternating

Key "Alt" pressed together with "+" or "-".

The burst packets will be generated alternating with positive and negative sign. According to which one of the keys [+] or [-] is pressed the polarity of the first packet is defined.

The shortest burst period in this mode is 300 ms.

All other parameters are settable in the given limits due to the available maximum unit power. The burst generator takes the keying ratio in account and provides proper display readings(see chapter 8, limit of parameters)

The changeover switching of relays, needed for this function, does not influence the shape of the pulses: Switching the relays is done before firing the pulses by the semiconductor switch.

6.5 Coupling network

The coupling network is used to superpose the pulses of the test-generator to the power leads of the testing object.

6.5.1 Coupling

The coupling circuit is configured by using the keys [Touch 1], following circuits can be realized:

- Phase (L) + Neutral (N) + Protection earth (PE) \Rightarrow Earth
This coupling is known as common mode or asymmetrical coupling.
- Phase (L) + Neutral (N) \Rightarrow Earth
- Protection earth \Rightarrow Earth.
The PE of the test object is decoupled from the mains by means of a choke. The pulses are directly coupled to the PE of the test object.
- Phase (L) \Rightarrow Earth.
- Neutral (N) \Rightarrow Earth.
- Phase (L) + Protection earth (PE) \Rightarrow Earth
- Phase (N) + Protection earth (PE) \Rightarrow Earth

The filter in the coupling network provides high impedance for the fast test-pulses and therefore isolates the common mains from the interference pulses and protects other electronic devices used close to the test generator. (See also block circuit diagram chapter 12

It should not be neglected or forgotten: the noise level in the proximity of the test generator is much higher than normal. For example the connected net cable as an antenna. It is recommended to use the test generator in a shielded room or faradays cage.

The coupling network has no internal fuses; the user has to provide proper fusing for the test object and the coupling network according to its power consumption. Fuse size must not exceed 16 A, see also technical data chapter9.2

6.5.2 Information regarding EUT supply

The applied voltage [Back 15] is only available with the electronics supply from the burst generator [Back 11] at the output [Front 2] and [Front 3].

6.6 Pulse output

The Fischer coaxial HV-jack [Front 10] provides the burst voltage and may be used as follows:

- Monitoring the pulses with the EFT 450-1 (54 dB, attenuator 500:1 on 50 ohm) or EFT 450-2 (60 dB, attenuator 1000:1 on 50 ohm). See also chapter 6.8.2) connecting the connector cable EFT 430 to the capacitive coupling clamp EFT 415.
 - A direct capacitive coupling to signal or I/O-leads is mostly not possible, because this would falsify their signals. Therefore the coupling is made using the capacitive clamp which couples along a distance of 1 m.
 - The generator EFT4-4 can be connected to both sides of the capacitive coupling clamp EFT 415.

Important information:

Before connecting the capacity coupling clamp, please take care, that the coupling paths at the coupling network [Touch 1] are switched OFF and no voltage is connected to the input at the coupling network [Back 15].

- Connecting the connector cable EFT 431 to the 3-phase coupling network CWG 520, CWG 523 or CWG 524.
 Since the test generator EFT4-4 uses a 1-phase coupling network, the test of 3-phase objects requires an external 3-phase coupling network.

6.7 DUT monitoring with EUT fail

If the EUT shows an error message, the EMC test can be interrupted with the help of the BNC connector [Back 14]. This requires a potential free contact. In case of a failure (DUT) the "EUT fail input" of the burst generator requires a short circuit for minimum 10 ms.

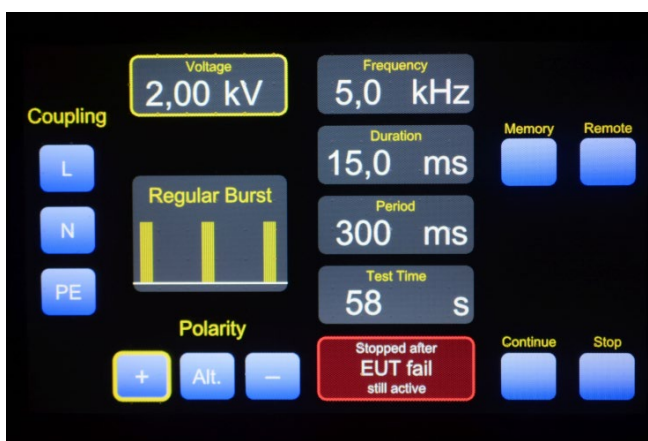

If the BNC input [Back 14] during the BURST operation is short circuited, the display shows following message:



and the BURST output is stopped (**Continue** flashes). All other settings remain as before use.

When the short circuit is no longer present the Message **still active** disappears.



With **Continue** the test can be continued or canceled with **Stop**.

6.8 Pulse check and measurements

6.8.1 Monitor output

This BNC output connector [Front 9] may be used to check the present parameters like frequency, burst duration, burst period and other functions. An oscilloscope with a small bandwidth allows checking this TTL-output signal.

6.8.2 Output High Voltage

At this HV socket [Front 10] the burst signal can be checked for his properties, such as voltage amplitude, rise time and pulse width.

By means of suitable attenuators such as EFT 450-1 (50 Ohm) and EFT 450-2 (1000 Ohm), the burst signal can be verified according the conditions laid down in the standard (IEC 61000-4-4) at 50 Ohm and 1 kOhm.

Caution: For the measurement of the impulse parameters the EFT must be set to the standard values according to the norm (5 kHz at 15ms burst duration or 100 kHz at 0.75 ms burst duration). This is necessary because the generator can supply much more energy than is required by the norm and therefore the attenuators can be overloaded and possibly destroyed.

The source impedance of the generator is 50 Ω. For a physically accurate measurement the HV output has to be closed with 50 Ω so the voltage divider divides the output voltage by two.

To protect the input of an oscilloscope against high voltages, attenuators include appropriate divider - see data sheet EFT 450. The measuring input of the used oscilloscope must be set to 50 ohm.

When using attenuators EFT 450 the following divider ratio arises:

- EFT 450-1 50 ohm 54 dB, corresponds to a divisor of 500:1 to 50 ohm
- EFT 450-2 1000 ohm 60 dB, corresponds to a divisor of 1000:1 to 50 ohm

Checking the values of a single pulse such as there voltage, rise time and pulse width is recommended to use an oscilloscope having a high bandwidth. We recommend an digital oscilloscope with more than 1 GS/s. Only with such measurement procedure the “ns pulses” are correct displayed.



6.9 Special functions

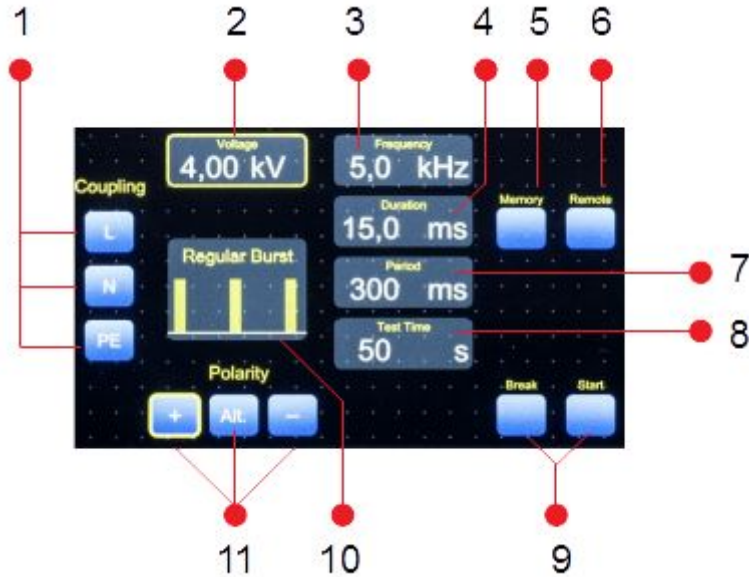

The special functions of the EFT4-4 can be selected by pressing [Touch 10]. All operation-modes are placed sequentially; every touch switches to the next function. Following special function sare available:

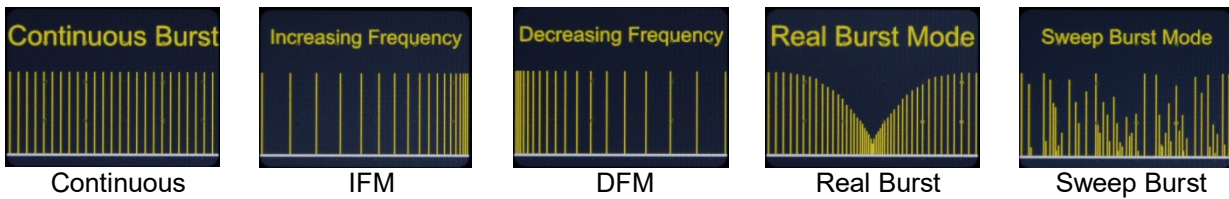

- Continuous Burst: packet length corresponds with the test time, see chapter 8.
- Increasing Frequency (IFM): increasing burst frequency in one packet with setted pulse-voltage.
- Decreasing Frequency(DFM): decreasing burst frequency in one packet with setted pulse-voltage.
- Real Burst Mode: decreasing burst frequency, same time increasing the pulse-voltage.
- Sweep Burst Mode: randomized frequency and voltage variation in one package.

By Tapping the **Frequency** key [3] the generator returns to **Regular Burst** mode.

6.9.1 Special function Continuous Burst

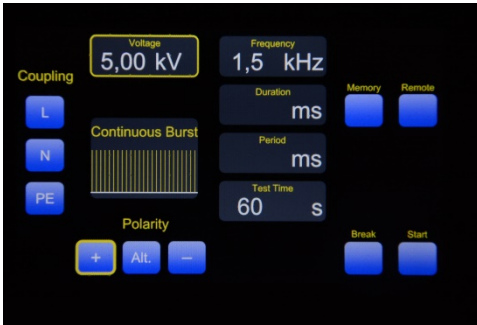

Frequency: adjustment as desired selectable, max. 5 kHz
Duration&Period: cannot be changed
Test Time: adjustment as desired selectable.

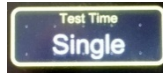

At display **Single** there will be only a pulse release when pressing **Start**[Touch 9].

At the function **Continuous Burst** the pulses with a duration time that meets the test time are coupled to the EUT. This is a very high stress for the EUT since it is a simple "energy view". Test with **Continuous Burst** can be used for example to track saturation effects in chokes.

If the EUT shows any influence the user will change to the variable test mode according chapter 6.3 to find the details of incompatibility and the exact reasons for this.

The maximum frequency depends on the voltage:

voltage range	burst frequency	pulses per second
0,10 - 2,00 kV	5 kHz	5000
2,01 - 3,00 kV	3 kHz	3000
3,01 - 5,00kV	1,5 kHz	1500

6.9.2 Special function IFM / Increasing Frequency mode



Frequency&Duration: cannot be changed
Period&Test Time: adjustment as desired selectable

The burst **Frequency** is varied continuously within one burst packet from 8,5 to 125 kHz. The burst duration is fixed to 15 ms and shown in the display duration [13].

The period can be varied according to the adjusted voltage:

- ≤ 2000 V from 50 ms until 1000 ms.
- > 2000 V until 3000 V from 83 ms until 1000 ms.
- > 3000 V until 5000 V from 166 ms until 1000 ms.

Using this test mode makes it easy to investigate resonance or saturation effects in the tested device. If the EUT shows any influence the user will change to the variable test mode according chapter 6.3 to find the details of incompatibility and the exact reasons for this.

6.9.3 Special function DFM / Decreasing Frequency mode



Frequency&Duration: cannot be changed

Period&Test Time: adjustment as desired selectable

The burst **Frequency** is varied continuously within one burst packet from 125 to 8,5 kHz. The burst **Duration** is fixed to 15 ms.

The period can be varied according to the adjusted voltage:

- ≤ 2000 V from 50 ms until 1000 ms.
- > 2000 V until 3000 V from 83 ms until 1000 ms.
- > 3000 V until 5000 V from 166 ms until 1000 ms.

This test mimics a part of the natural behavior of the burst phenomenon. In the natural phenomenon, a reduction in the burst frequency occurs simultaneously with an increase in the pulse voltage. In order to simplify the determination of a possible cause of the error, an increase in the pulse voltage was dispensed in the case of the special function DFM. This allows the examiner to focus on a single parameter, the burst frequency change. If an examinee is influenced, one can determine the exact cause by testing the details with the variable test (See on chapter 6.3).

6.9.4 Special function Real Burst Mode

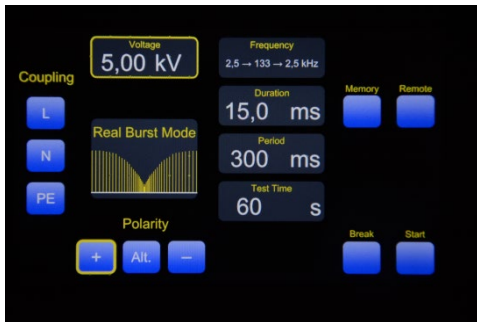

Frequency & Duration: cannot be changed
Period & Test Time: adjustment as desired selectable

The burst **Frequency** is varied continuously within one burst packet from 2,5 to 133 kHz and back to 2,5 kHz. Simultaneously the **Voltage** is varied from the value shown in display voltage [Touch 2] down to 0 kV and back to the original value. The burst **Duration** is fixed to 15 ms.

The period can be varied according to the adjusted voltage:

- ≤ 2000 V from 120 ms until 1000 ms.
- > 2000 V until 3000 V from 200 ms until 1000 ms.
- > 3000 V until max. 5000 V from 400 ms until 1000 ms.

This test mode simulates the natural burst phenomenon. At the natural phenomena a decrease of the burst frequency comes simultaneously with the increasing of the pulse-voltage. If the EUT shows any influence the user will change to the variable test mode according Ch. 6.3 to find the details of incompatibility and the exact reasons.

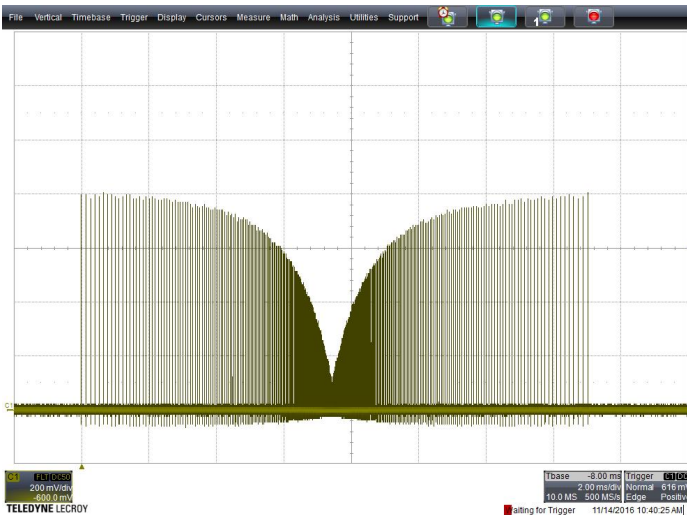

Example for „Real Burst“

6.9.5 Special function Sweep Burst Mode

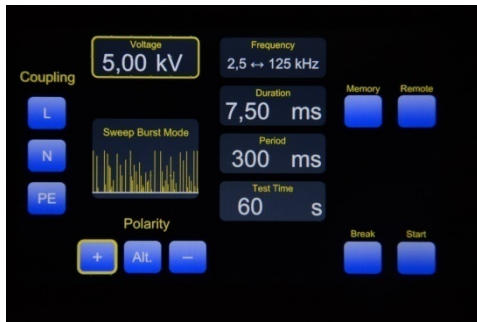

Frequency&Duration: cannot be changed
Period&Test Time: adjustment as desired
 selectable

The burst **Frequency** is varied by random within one burst packet from 2,5 to 125 kHz. Simultaneously the **Voltage** is varied by random between the value shown in display voltage [Touch 2] and 0 kV. The burst duration is fixed to 7,5ms].

The period can be varied according to the adjusted voltage:

- ≤ 2000 V from 60 ms until 1000 ms.
- > 2000 V until 3000 V from 100 ms until 1000 ms.
- > 3000 V until max. 5000 V from 200 ms until 1000 ms.

This test mode simulates the burst phenomenon while bouncing of an electrical contact, for example in relay controls.

If the EUT shows any influence the user will change to the variable test mode according chapter6.3 to find the details of incompatibility and the exact reasons for this.

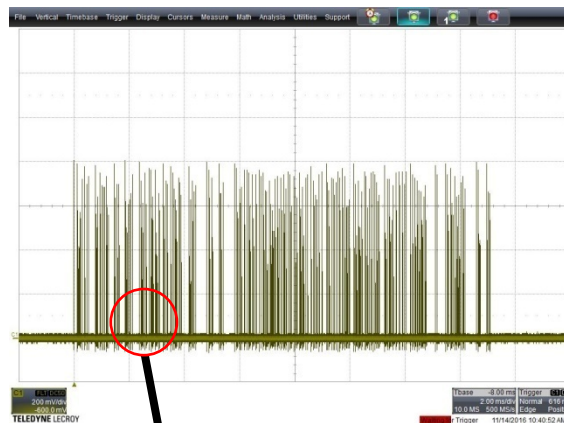

Example for burst packet “sweep”

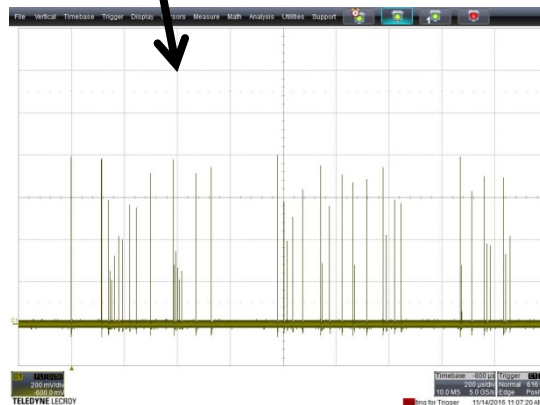

6.10 Memory-function

6.10.1 General description

With the aid of the memory key [Touch 5] up to 32 settings can be stored and recalled. All variable parameter and the key positions are fixed for recall.

The first pressing of the **Memory** key activates the memory function.

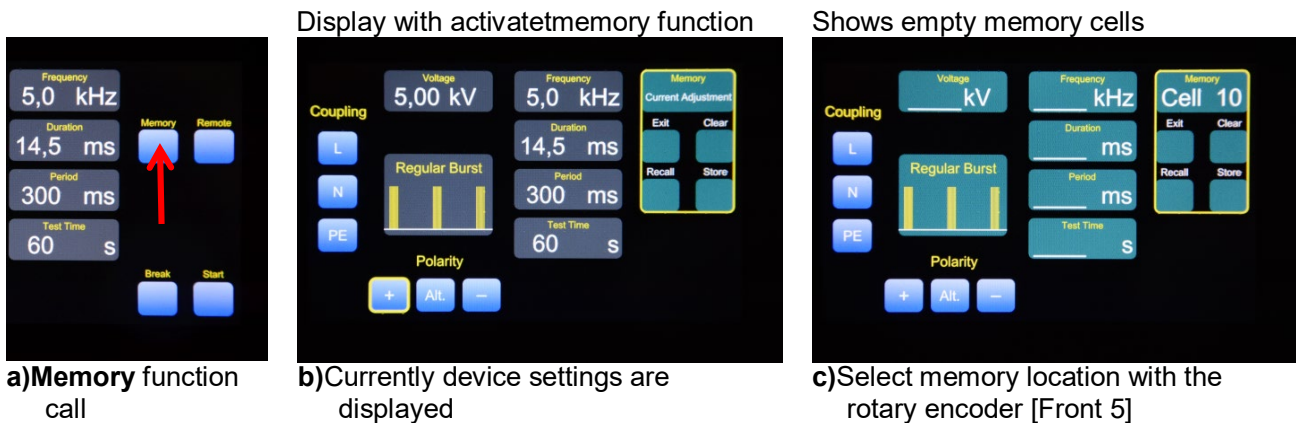

The touch fields of the Memory function:

- With **Store** the generators settings are stored in the previously selected memory location.
- With **Recall**, the stored parameters are taken over by the generator
- With **Clear** the parameters in the selected memory location are cleared
- With **Exit** the memory function is Finished. (no changes are accepted)

The memory locations 01 to 32 are freely adjustable. (Upon delivery of the generator, the memory locations 01 to 04 are provided for the test levels 1 – 4, based on burst 5 kHz and the memory locations 05 to 08 are provided for the test levels 1 – 4, based on burst 100 kHz.)

If the memory space is occupied, the stored data such as **Voltage**, **Frequency**, **Duration** and **Period** appear. Also, the information of the corresponding operating conditions of **Coupling** and **Polarity**.

6.10.2 Examples on the usage of the memory key

1. Store values, e.g. to **Cell 12**
 - First adjust the desired values at the generator and then call the **Memory** function [Touch 5].
 - Set the desired **Memory** location **Cell 12** with the help of the rotary encoder [Front 5].
 - The **Store** button is used to save the settings to memory and exit the memory function.
2. Call values from memory, e.g. from **Cell 03**
 - Use rotary encoder [Front 5] to select the memory location Cell 03. The existing values are displayed.
 - With the key **Recall** the parameters from the memory are taken over by the generator and the memory mode is left.
3. Clear values, e.g. in **Cell 20**
 - Call **Memory** function [Touch 5].
 - Call **Cell 20** with rotary encoder [Front 5].
 - The **Clear** button clears all parameters in memory 20.
 - Subsequently, further memory locations can be selected and cleared with **Clear**.
 - The memory mode is only exited with the **Exit** button

7 Test procedure

The correct test setup can be found in the standard: IEC 61000-4-4 / EN 61000-4-4

8 Limits of parameters

The design of the generator EFT4-4 makes it superior to the pre given values of IEC 61000-4-4, it will exceed a lot of values in a wide range. But there are limits for some settable parameters of the generator due to its limited power which will be described below:

A) Variable voltage

voltage [kV]	max. frequency cont. burst [kHz]	max. pulses / sec	max. pulses / packet
0,20 - 2,00	5	5000	500
2,01 - 3,00	3	3000	500
3,01 - 5,00	1,5	1500	500

B) Alternating operation

Like point "A", the minimum burst period must be 300 ms.

9 Technical data

9.1 Generator unit

Switching element	semiconductor switch
Output voltage, adjustable	100 - 5000 V (meets the standard from 200V to 5 kV) into 10 V steps
Wave shape according IEC 61000-4-4	5ns / 50 ns
Polarity (burst packet), selectable	pos., neg., altern.
Spike frequency	single pulse to 125 kHz
Step rate spike frequency:	0,1 - 10 kHz 0,1 kHz-steps 10,5 - 50 kHz 0,5 kHz-steps 51,0 -100 kHz 1 kHz-steps 105,0 -125 kHz 5 kHz-steps
Burst duration, continuous adjustable	0,01ms to 100 ms *)
Burst period	10 ms to 1000 ms *)
Triggering	manually or external
HV-output	coaxial connector
Monitor output	BNC, TTL-level
Fan, temperature-controlled	activate by 40° C (deactivate by 32° C)

9.2 Coupling network

This is part in the cabinet of the test generator EFT4-4.

Operating voltage/ -current AC	max. 230 V /16A 50 Hz
Operating voltage/ -current DC	max. 110 V / 8A
Serial choke inductive	150 µH / 16 A
Phase indicator	LED red / green
Coupling capacity	33 nF
Different coupling modes (Adjustable by keys)	L, N, PE -> E; L -> E; N -> E; PE -> E L; N -> E; L, PE -> E; N, PE -> E
Test object connector	wall outlet DIN - protection earth Additional laboratory jacks
Earth	auxiliary earth connector jack

9.3 General

Operation temperature	0 to 40 °C
Power supply	100 - 240 V AC / 47 - 63 Hz, 160 VA
Housing	19 " rack, 3HE (450 x 430 x 150 mm (L x D x H))
Weight	approx. 9 kg

*) see chapter 8Limits of parameters

13 Block schematic EFT4-4

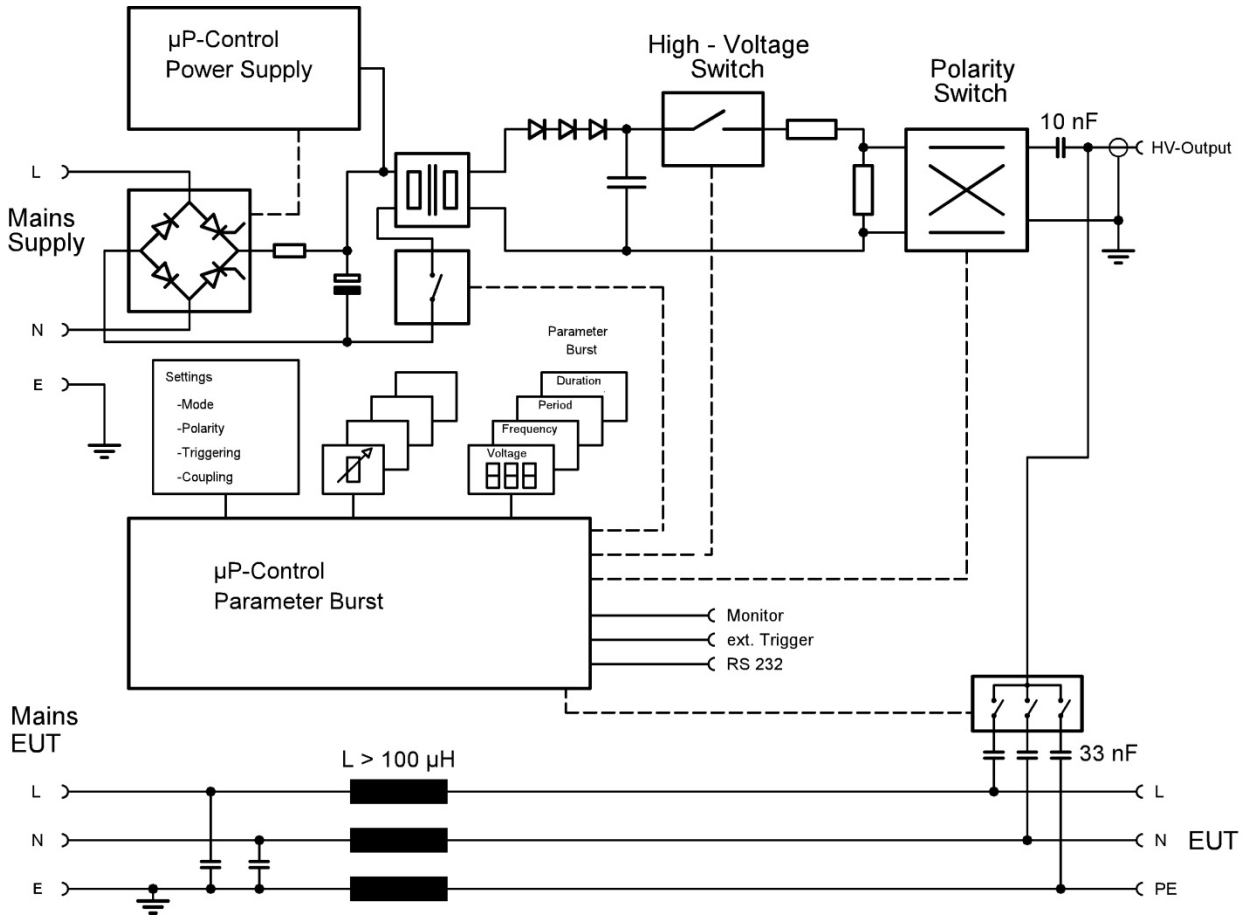

Figure6

14 Address of the Manufacturer:

Toll Free | 844.423.7435 Local | 916.918.2975 Fax | 916.218.6401
 E-mail: sales@theemcshop.com
 www.theemcshop.com
 California - HQ 7401 Galilee Rd. #160 Roseville, CA 95678