

RTP Series Real Time Power Sensors



98408000A | Rev 20190619

INSTRUCTION MANUAL, RTP Series USB Power Sensors with Boonton Power Analyzer Software

Revision 20190619

© Copyright 2016-2019, by BOONTON Electronics, a subsidiary of the Wireless Telecom Group, Inc.
Parsippany, NJ, USA. All rights reserved.

P/N 98408000A

This manual covers the 55000, RTP5000 and RTP4000 Series power sensors, serial numbers: 1001 and higher.

The RTP Series Firmware and Boonton **Power Analyzer Software** is licensed by Boonton Electronics, a subsidiary of the Wireless Telecom Group, Inc.

SAFETY SUMMARY

The following general safety precautions must be observed during all phases of operation and maintenance of this instrument. Failure to comply with these precautions or with specific warnings elsewhere in this manual violates safety standards of design, manufacture, and intended use of the instrument. Boonton Electronics assumes no liability for the customer's failure to comply with these requirements.

DO NOT OPERATE THE INSTRUMENT IN AN EXPLOSIVE ATMOSPHERE

Do not operate the instrument in the presence of flammable gases or fumes.

KEEP AWAY FROM LIVE CIRCUITS

Operating personnel must not remove instrument covers. Component replacement and internal adjustments must be made by qualified maintenance personnel. Do not replace components with the power cable connected. Under certain conditions dangerous voltages may exist even though the power cable was removed, therefore; always disconnect power and discharge circuits before touching them.

DO NOT SERVICE OR ADJUST ALONE

Do not attempt internal service or adjustment unless another person, capable of rendering first aid and resuscitation, is present.

DO NOT SUBSTITUTE PARTS OR MODIFY INSTRUMENT

Do not install substitute parts or perform any unauthorized modifications on the instrument. Return the instrument to Boonton Electronics for repair to ensure that the safety features are maintained.

SAFETY SYMBOLS

This safety requirement symbol has been adopted by the International Electro-technical Commission, Document 66 (Central Office) 3, Paragraph 5.3, which directs that an instrument be so labeled if, for the correct use of the instrument, it is necessary to refer to the instruction manual. In this case it is recommended that reference be made to the instruction manual when connecting the instrument to the signal source and USB host.



The CAUTION symbol denotes a hazard. It calls attention to an operational procedure, practice or instruction that, if not followed, could result in damage to or destruction of part or all of the instrument and accessories. Do not proceed beyond a CAUTION symbol until its conditions are fully understood and met.



The NOTE symbol is used to mark information which should be read. This information can be very useful to the operator in dealing with the subjects covered in this section.



The HINT symbol is used to identify additional comments which are outside of the normal format of the manual, however can give the user additional information about the subject.

Table of Contents

1. General Information	1-1
1.1 Organization	1-1
1.2 Description	1-2
1.3 Architecture.....	1-3
1.4 Accessories	1-4
2. Hardware Installation	2-1
2.1 Unpacking & Repacking.....	2-1
2.2 Installing the Power Analyzer Software	2-3
2.3 Sensor Connections.....	2-6
2.4 Power Requirements.....	2-6
2.5 Status LED codes.....	2-7
3. Getting Started.....	3-1
3.1 Connecting the RTP Series Real-Time Power Sensors.....	3-1
3.2 Introduction to the Power Analyzer Software	3-2
3.2.1 Docking Windows.....	3-4
3.2.2 Main Application.....	3-5
3.2.3 Available Resources Window:.....	3-5
3.2.4 The Main Toolbar	3-5
3.2.5 Trace View Window	3-6
3.2.6 Channel Control Window.....	3-8
3.2.7 Time / Trigger Settings Window	3-9
3.2.8 Marker Settings Window	3-10
3.2.9 Pulse Definitions Window.....	3-10
3.2.10 Automatic Measurements Window.....	3-11
3.2.11 Display Settings Window.....	3-13
3.2.12 CCDF View Window (RTP5000 Only).....	3-14
3.2.13 Statistical Measurements Window (RTP5000 only).....	3-15
4. Operation.....	4-2
4.1 Power Analyzer Software	4-2
4.1.1 Initializing the Software	4-2
4.1.2 Connecting the RTP Series Real-Time Power Sensor	4-3
4.1.3 The Trace View Display	4-4
4.1.4 The Main Toolbar.....	4-7
4.1.5 Time/Trigger Control Window	4-9
4.1.6 Channel Control Window.....	4-13
4.1.7 Automatic Measurements Display.....	4-16
4.1.8 Pulse Definitions Window.....	4-17
4.1.9 Marker Settings Window	4-18
4.1.10 Statistical CCDF Graph Display (RTP5000 only).....	4-20
4.1.11 Statistical Mode Control Window (RTP5000 only).....	4-20
4.1.12 Statistical Measurements Display (RTP5000 only).....	4-22
4.1.13 Modulated Mode Measurements Display	4-23
4.1.14 Acquisition Status Bar	4-25
4.1.15 Archiving Measurement Setups.....	4-25
4.2 Multichannel Operation	4-26
4.2.1 Multichannel Measurements.....	4-26
4.2.2 Multichannel Triggering.....	4-28

4.2.3	Multichannel Individual Sensor Tabs	4-30
4.3	Measurement Buffer Mode (API remote programming only)	4-31
4.3.1	Overview	4-31
4.3.2	Measurement Buffer Mode Operation	4-33
4.3.3	Measurement Buffer Mode User Settings	4-38
5.	Remote Programming	5-2
5.1	Introduction	5-2
5.2	Examples	5-2
5.3	Communication overview	5-3
6.	Making Measurements	6-1
6.1	Pulse Measurements	6-1
6.1.1	Pulse Definitions	6-1
6.1.2	Standard IEEE Pulse	6-1
6.1.3	Automatic Pulse Measurements	6-2
6.1.4	Automatic Pulse Measurement Criteria	6-3
6.1.5	Automatic Pulse Measurement Sequence	6-4
6.2	Marker Measurements	6-7
6.2.1	Average Power Over a Time Interval	6-8
6.3	Automatic Statistical Measurements	6-9
7.	Maintenance	7-2
7.1	Safety Recommendation	7-2
7.2	Cleaning	7-2
7.3	Inspection and Performance Verification	7-2
7.4	Connector Care	7-2
7.5	Software and Firmware Updates	7-4
7.5.1	Firmware Update Procedure	7-4
7.5.2	Power Analyzer Software Update Procedure	7-7
8.	Appendix A Software Licenses	8-1
8.1	End User Licence Agreement (EULA)	8-1
8.2	Open Source Attributions	8-2
9.	Appendix B Warranty & Repair	9-1
9.1	Repair Policy	9-1
9.2	Contacting Boonton	9-1
9.3	Limited Warranty	9-2

1. General Information

The user manual provides the information needed to install, operate and maintain the Boonton RTP5000 Real-Time Peak Power Sensors and RTP4000 Real-Time True Average Power Sensors. The 55 Series Sensors are also supported in this manual.

Chapter 1 is an introduction to the manual and the instrument.

1.1 Organization

The manual is organized into seven chapters, as follows:

Chapter 1 - General Information presents summary descriptions of the instrument and its principal features, accessories and options. Also included are specifications for the instrument.

Chapter 2 – Hardware Installation provides instructions for unpacking the instrument, setting it up for operation, connecting power and signal cables, and initial power-up.

Chapter 3 - Getting Started describes the basic operation of the RTP Series Real-Time Power Sensors and the Power Analyzer Software.

Chapter 4 - Operation describes, in detail, the Graphical User Interface (GUI) of the Power Analyzer Software and the RTP Series Real-Time Power Sensors.

Chapter 5 - Remote Programming explains the command set and procedures for operating the instrument remotely.

Chapter 6 – Making Measurements provides definitions for key terms used in this manual and on the GUI displays as well as methodologies used to calculate automated pulse, marker and statistical measurements.

Chapter 7 - Maintenance includes procedures for installing software and verifying fault-free operation.

1.2 Description

Boonton once again sets the standard for fast RF power measurements with the RTP Series Real-Time Power Sensors. Built with Boonton's Real-Time Power Processing™ technology (patent pending), this modular product line offers speed and accuracy never seen in a USB form factor. The new line includes 6, 18 and 40 GHz models, and is designed for measurement of wideband modulated signals.

The RTP Series Real-Time Power Sensors are the latest series of products from Boonton Electronics that turn your PC or laptop using a standard USB 2.0 port into a state-of-the-art peak power analyzer without the need for any other instrument. Power measurements from the RTP Series Real-Time Power Sensors can be displayed on your computer or can be integrated into a test system with a set of user-defined software functions.

The RTP5000 Real-Time Peak Power Sensors include the models RTP5006, RTP5318, RTP5340, RTP5518, and RTP5540. Collectively they cover a frequency range of 50 MHz to 40 GHz. Offering broadband measurements with rise times up to 3 ns, time resolution of 100 ps, and video bandwidths up to 195 MHz.

The RTP4000 Real-Time Peak Power Sensors include the models RTP4006, and RTP4106. Collectively they cover a frequency range of 4 kHz to 6 GHz. Offering broadband measurements with rise times up to 2 μ s time resolution and video bandwidths up to 175 kHz.

The RTP Series Real-Time Power Sensors enable rapid pulse integrity determinations. Effective sampling rate is up to one hundred times faster than conventional power meters so finer waveform details are visible. They perform automatic capture of pulse power, overshoot, droop, edge delay and skew timing, and edge transition times.

The RTP5000 Real-Time Power Sensors have exceptional trigger stability of less than 100 ps trigger jitter regardless of the trigger source which yields much greater waveform detail because a stable trigger point yields a stable waveform. Using dedicated trigger circuitry rather than software-based triggering provides precise timestamping of relative trigger-to-sample delay. This precision permits the use of random interleaved sampling (RIS) for repetitive waveforms with resulting effective sampling rate of 10 GS/s which permits accurate, direct measurement of fast timing events without requiring interpolation between samples.

Real Time Power Processing offers new possibilities for power integrity measurements because every pulse is analyzed and none are discarded. Trace acquisition, averaging and envelope times are drastically reduced resulting in simultaneous analysis of average, peak and minimum Power.

The RTP Series Real-Time Power Sensors are supported by the **Power Analyzer Software**, a Windows based software package that provides control and readout of the sensors. It is an easy to use program that provides both time and statistical domain views of power waveforms with variable peak hold and persistence views. Power measurements are supported using automated pulse and statistical measurements, power level and timing markers. The GUI application is easily configured with dockable or floating windows and measurement tables that can be edited to show only the measurements of interest.

The [RTP Series Power Sensor Programming Reference](#) provides basic information on using the RTP Series Real-Time Power Sensor Application Programming Interface (API) in an end-user application. The API consists of a Dynamic Link Library, which is required for use of the **Power Analyzer Software**. The API includes a programming reference, as well as code examples for C++, C# and Visual Basic.

The RTP Series Real-Time Power Sensors are ideal for manufacturing, design, research, and service in commercial and military applications such as telecommunications, avionics, RADAR, and medical systems. They are the instrument of choice for fast, accurate and highly reliable RF power measurements, equally suitable for product development, compliance testing, and site monitoring applications.

1.3 Architecture

The Sensor functions as an ultra-fast, calibrated power measurement tool, which acquires and computes the instantaneous, average and peak RF power of a wideband modulated RF signal. The internal A/D converter samples the detected RF signal at up to 100 Msamples/second, and a digital signal processor carries out the work required to form the digital samples into a correctly scaled and calibrated trace on the display. Figure 1.1 shows a block diagram of the peak power sensor.

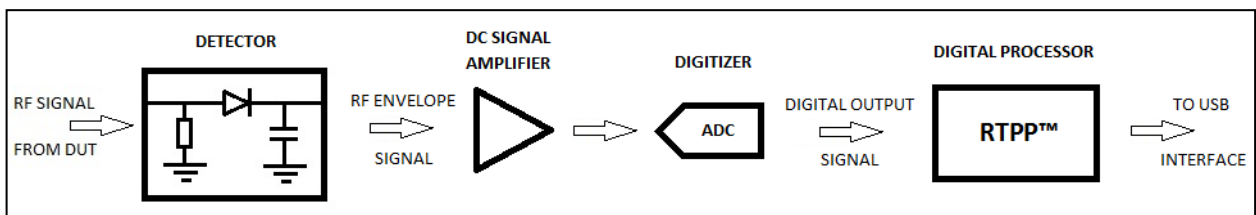

Figure 1.1 RTP Series Real-Time Power Sensors Block Diagram

The first and most critical stage of a peak power sensor is the detector, which removes the RF carrier signal and outputs the amplitude of the modulating signal. The width of the detector’s video bandwidth dictates the sensor’s ability to track the power envelope of the RF signal. The picture on the left in Figure 1.2 below shows how a detector with insufficient bandwidth is unable to faithfully track the signal’s envelope, therefore affecting the accuracy of the power measurement. The detector on the right has sufficient video bandwidth in order to track the envelope accurately. The fast detectors used in peak power sensors are by their nature non-linear, so shaping procedures within the digital processor must be used in order to linearize their response. When measuring instantaneous peak power, a high sample rate is important in order to ensure that no information is lost. The RTP Series Real-Time Power Sensors have a sample rate of 100 MHz (RTP5000) or 25 MHz (RTP4000), enabling capture and analysis of power versus time waveforms at very high resolution.

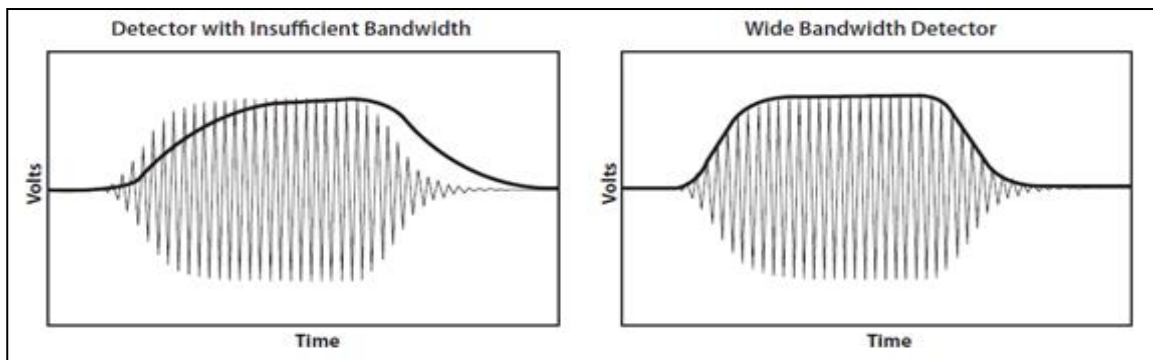

Figure 1.2 Detector Envelope Tracking Response

1.4 Accessories

The RTP Series Real-Time Power Sensors are shipped in a carrying case which includes the following accessories:

- USB Type-A Cable (6 ft)
- External Trigger Multi-I/O Cable (SMB to BNC)
- Trigger Sync Cable (SMB to SMB) for triggering multiple sensors
- RTP Series Welcome Card containing URL to downloadable **Power Analyzer Software**, drivers and documentation on Boonton website

2. Hardware Installation

This section contains unpacking and repacking instructions, power requirements, connection descriptions and preliminary checkout procedures.

2.1 Unpacking & Repacking

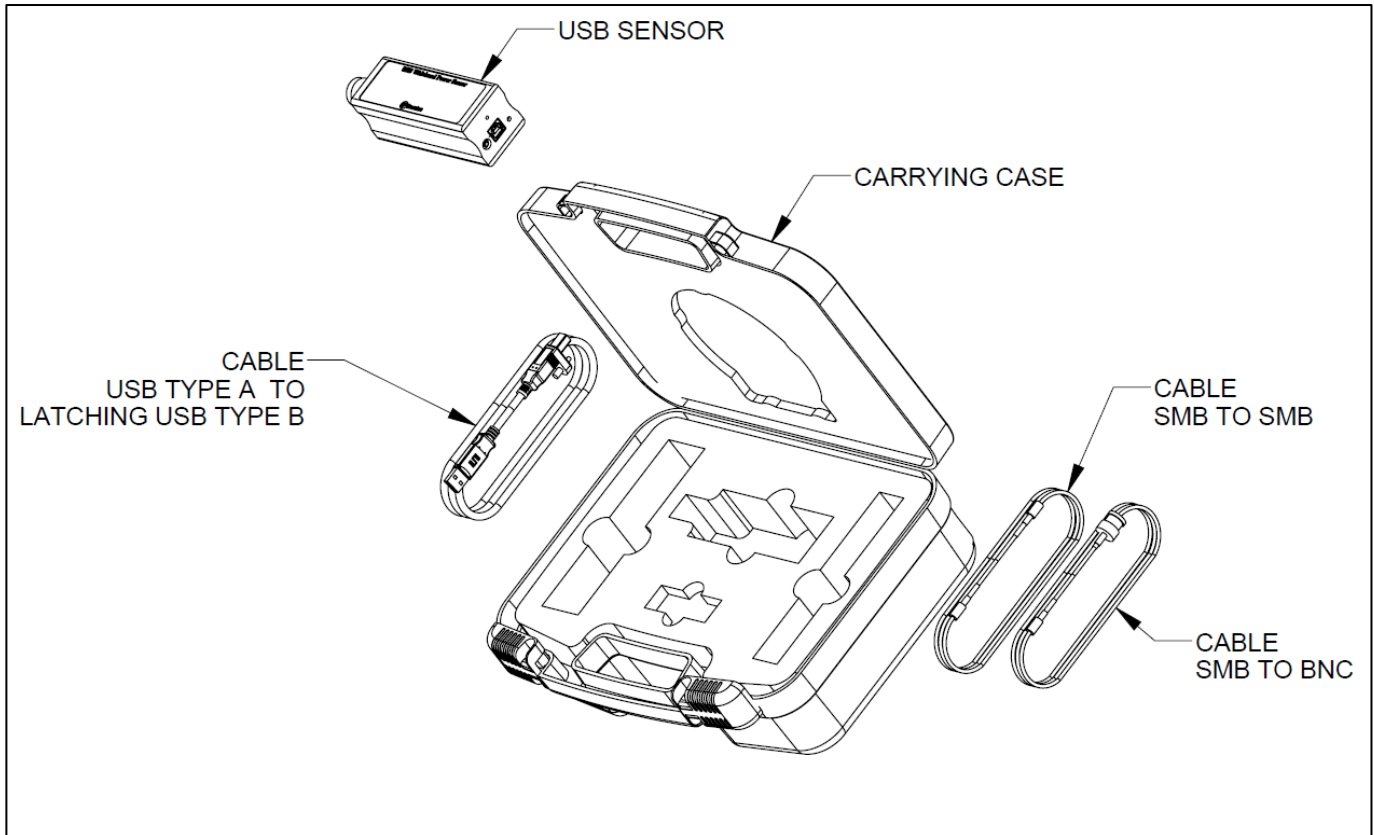

Figure 2.1 RTP Series Real-Time Power Sensors kit contents

The RTP Series Real-Time Power Sensors are shipped complete and are ready to use upon receipt. Figure 2.1 illustrates the various pieces included with the power sensor and where they are loaded into the container. Actual details may vary from the illustration.



NOTE: Save the packing material and container to ship the instrument, if necessary. If the original materials (or suitable substitute) are not available, contact Boonton Electronics to purchase replacements. Store materials in a cool, dry environment.

Before you start, make sure you have the following items in your power sensor package as shown in Figure 2.2.

1. Power Sensor
2. USB Type-A Cable (6 ft)
3. External Trigger Multi-I/O Cable (SMB to BNC)
4. Trigger Sync Cable (SMB to SMB) for triggering multiple sensors
5. Information Card on where to find related software and documentation.



Figure 2.2 RTP Series Real-Time Power Sensors accessories as packed for shipping

If any of these items are missing or damaged, then please contact your local representative immediately and refer to “Contact and Support” section of this guide.

2.2 Installing the Power Analyzer Software

This section describes the installation and use of the **Power Analyzer Software** for RTP Series Real-Time Power Sensors. Before you start, check your PC for software compatibility.



CAUTION: Do not connect the power sensor to your PC until you have installed the **Power Analyzer Software**.

The **Power Analyzer Software** requires the following minimum computer characteristics:

Processor	1.3 GHz or higher recommended
RAM	512 MB (1 GB or more recommended)
Operating System	Microsoft® Windows® 10 Microsoft® Windows® 8 (32-bit and 64-bit) Microsoft® Windows® 7 (32-bit and 64-bit)
Hard-Disk Free Space	Min 1.0 GB free space to install or run
Display Resolution	800x600 (1280x1024 or higher recommended)
Interface	USB 2.0 high speed

Procedure:

To install the **Power Analyzer Software**, follow these steps:

Install the **Power Analyzer Software** by selecting  **BPAInstaller**. The installation package can be downloaded from "Manuals & Software" section of the product page on Boonton website:

https://www.boonton.com/products/real-time-power-sensors/rtp5000-real-time-peak-power-sensors?go=manuals_software

- (1) The Installation process is initiated by running "BPAInstaller.exe" with admin permissions. When you select the  **BPAInstaller** for the first time, read the license agreement, accept it and then click on "Install" in order to proceed with the installation process.

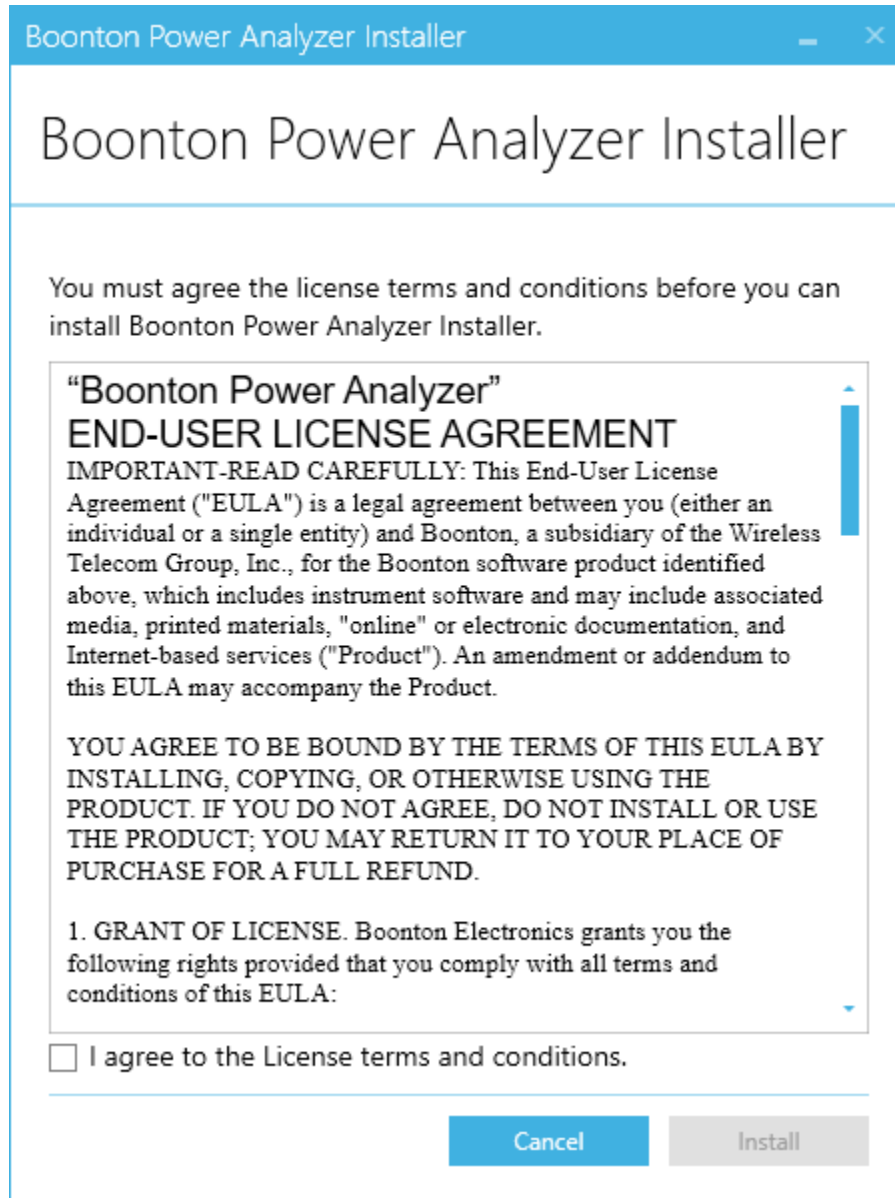

Figure 2.3

- (2) By default the main software application will be installed in the following folder: **C:\Program Files (x86)\Boonton\Power Analyzer**. Once the installation has successfully completed, Click the "Close" button to exit the wizard. Double click the **Power Analyzer** icon on the desktop to launch the application.

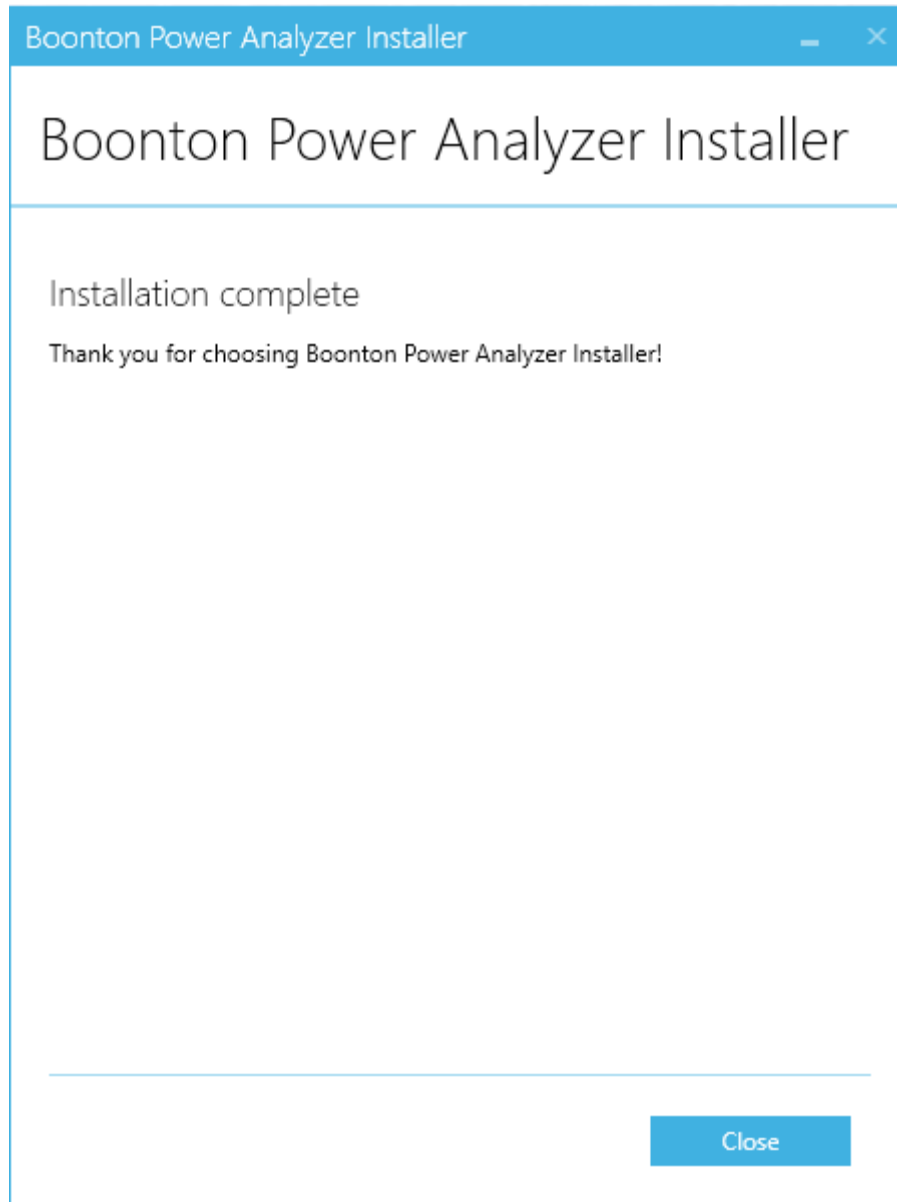

Figure 2.4

2.3 Sensor Connections

The end panel of the RTP Series Real-Time Power Sensor shown in Figure 2.5, has two connectors and the Status LED. The center connector is a USB 'Type B' receptacle used to connect the power sensor to the host computer. The connector labelled Multi I/O is an SMB plug and can serve as a trigger input, status output, or as a trigger synchronization interconnect when multiple power sensors are used.



Figure 2.3 The power sensor end panel showing the connectors and Status LED.

Connect the power sensor to your PC through the supplied USB cable. Note that the cable should be secured to the sensor using the captive screw on the USB plug. The power sensor is USB 2.0 compatible. It is recommended that you use the USB cable supplied with your sensor.

Connect power sensor to RF Source. All RTP Series Real-Time Power Sensors models are equipped with either a precision Type-N male RF connector or a precision, 2.92 mm male RF connector. Connect the power sensor to the RF signal to be measured.



- **CAUTION:** Do not rotate the body of the sensor when connecting the sensor to a unit under test (UUT). To avoid internal sensor damage, connect and disconnect the sensor by turning the metal nut only.
- **CAUTION:** Ensure that you do not apply any excessive force on the sensor once it has been connected.
- **CAUTION:** Do not apply RF power levels greater than +20 dBm to the RF input of the sensor.

2.4 Power Requirements

The RTP Series Real-Time Power Sensors require 2.5 Watts at 5 Volts, this is supplied via a USB port. The power sensor MUST be connected to a USB 2.0 port that is able to supply the full 500 mA.



NOTE: Usually a USB 2.0 port is capable of supplying 500 mA current through its port. When an unpowered USB hub is used (sometimes the hub is internal), available current may need to be shared between connected devices.

2.5 Status LED codes

The end panel, shown in Figure 2.5, includes a Status LED. The color and flash pattern indicate the sensors status as indicated on the label on the side panel shown in Figure 2.6.



Figure 2.6 The information labels on the RTP Series Real-Time Power Sensor contain information on the maximum power levels the device can handle and the meaning of the various status LED flash patterns.

THIS PAGE INTENTIONALLY LEFT BLANK

3. Getting Started

This chapter will introduce the RTP Series Real-Time Power Sensors, and will discuss basic connection and operation. For additional information please see Chapter 4 "Operation."

3.1 Connecting the RTP Series Real-Time Power Sensors

Following unpacking and software installation discussed in Chapter 2 of this guide, a sensor device can be connected to the USB port of the PC.

When the sensor device is first connected to the USB port, there will be a one-time driver file installation. Wait until you see an automatic device detection message and Windows OS installs the driver file. Note, older or newer operating system may behave differently. Contact Boonton Electronics if you have a problem.

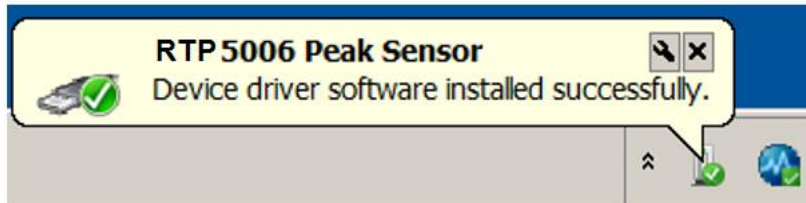



Figure 3.1 Windows popup showing that the USB Driver for RTP Sensors has been installed.

3.2 Introduction to the Power Analyzer Software

Once you have installed the software, configured your USB drivers and connected the power sensor to the PC, you are ready to make measurements using the **Power Analyzer Software**.



NOTE: The USB Driver for RTP Sensors file is provided by Boonton Electronics/Wireless Telecom Group, and digitally signed by Microsoft Corporation.

Open the **Power Analyzer Software** from the “Boonton” group in the Windows Start Menu or by double clicking on the desktop icon  .

A splash screen will welcome you to the application.



Figure 3.2 The **Power Analyzer Software** splash screen for version 3.0.12.0.

Under "**Available Resources**", a pop up box will appear as below with the list of connected devices name and hardware information. The initial view of the **Power Analyzer Software** is shown in Figure 3.3, although display colors may be different.

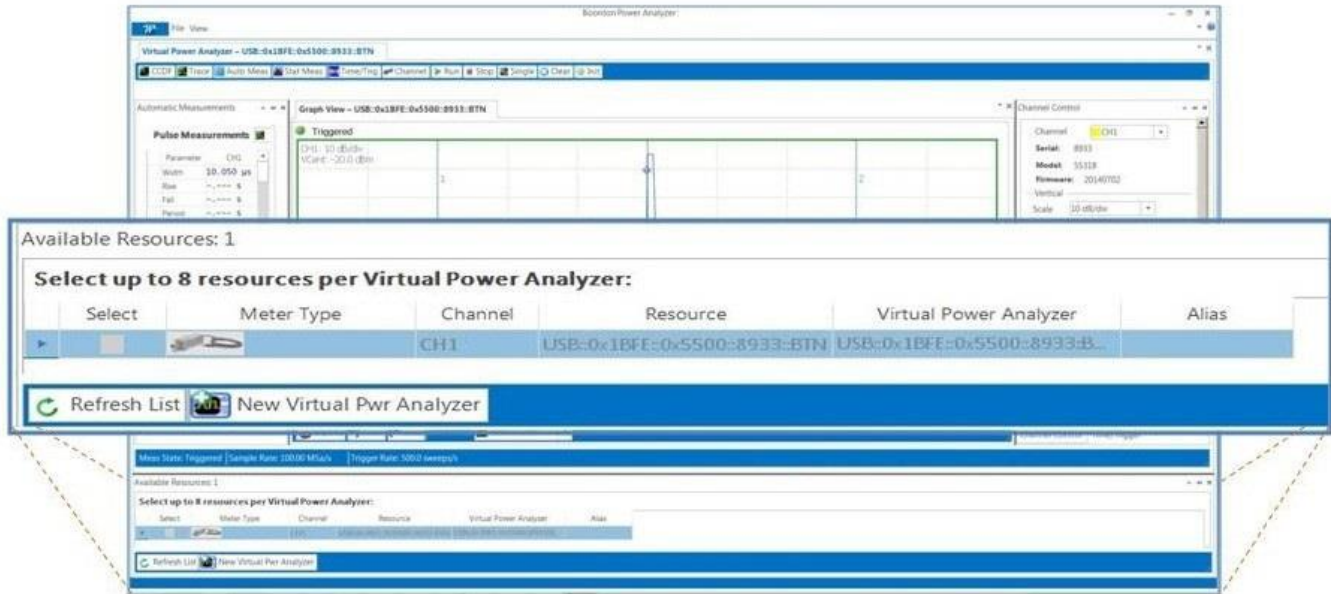

Figure 3.3 The Available Resources box shows connected devices

In the Available Resources window, check the "**Select**" box for one or more connected sensors, then click "**New Virtual Pwr Analyzer**". This will launch a new Virtual Power Analyzer instance containing trace and control windows. If you have a RF signal connected already to the USB sensor, the measured signal's waveform will appear in the trace window.

A "Virtual Power Analyzer" is analogous to a benchtop RF Power Analyzer with one or more sensors connected. Time and trigger controls are typically common to all sensors within a Virtual Power Analyzer, while channel-specific controls are available for most other settings. This offers users the familiar, multi-channel approach common to power meters and oscilloscopes.

When independent control of timebase-related settings is desired, it is possible to open multiple Virtual Power Analyzers, each with their own full set of controls.

3.2.1 Docking Windows

The **Power Analyzer Software** uses dockable windows to allow the user to arrange the various windows in the configuration of their choice. You can drag a docked window by clicking its title bar. This action enables you to move the window to a different docked position or undock it.

To dock tool windows

- Click the tool window you want to dock.
- Drag the window toward the middle of the software main window.
- A guide diamond will appear with four arrows pointing toward the four sides of the main window.
- When the tool window you are dragging reaches the location where you want to dock it, move the pointer over the corresponding portion of the guide diamond. The designated area is shaded blue.
- To dock the window in the position indicated, release the mouse button. Note that docked windows can be overlapped. By selecting individual tab it is possible to resize each tool windows and can be repositioned as below picture.
- Alternatively, you can dock a tool window to a portion of one of the side walls of the software by dragging it to the side until you see a secondary guide diamond. Click one of the four arrows to dock the tool window to that portion of the side wall.

The following diagram shows the guide diamonds with arrows that appear when you drag a tool window toward the center of the Boonton software main window. The diamond on the right edge only appears when you drag a tool window toward the edge of the main application box window.

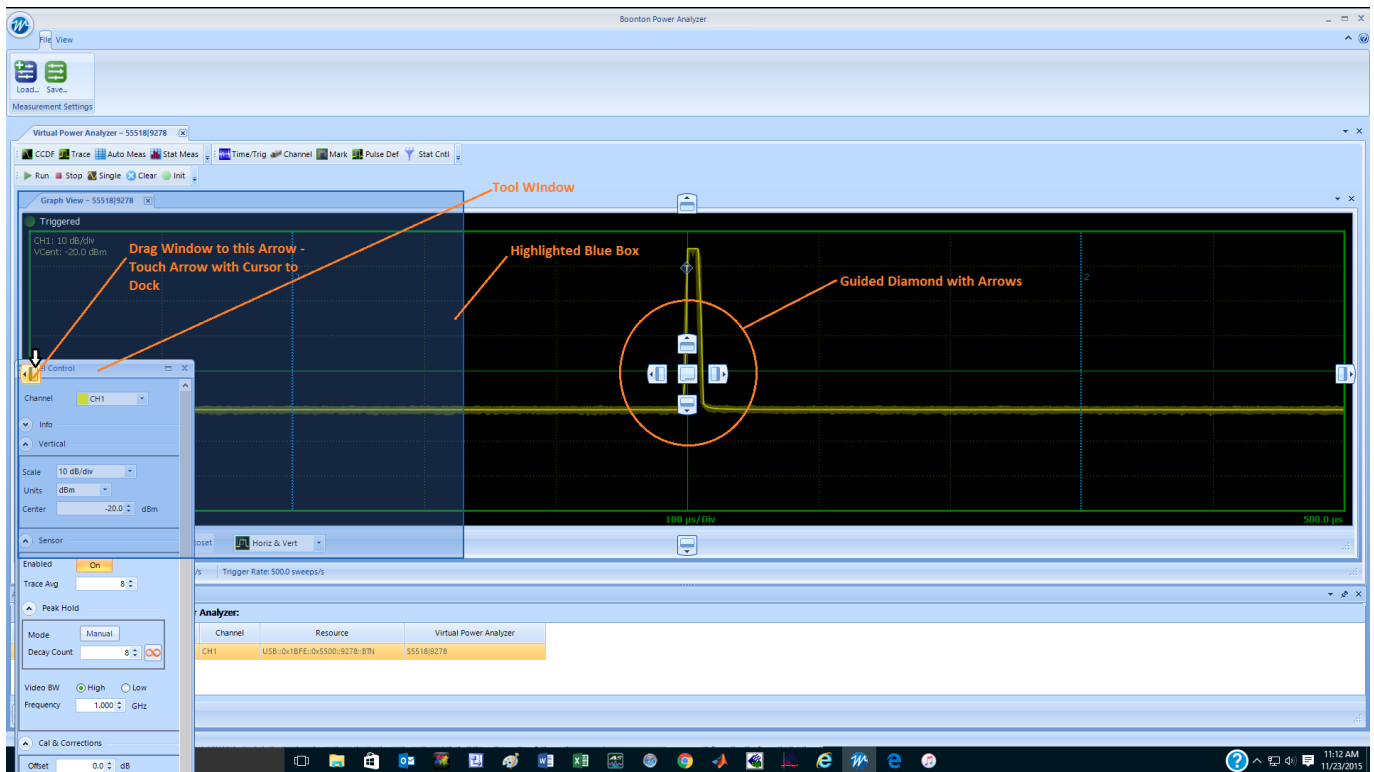

Figure 3.4 Docking a sidebar to the left side of the display



NOTE: Each of the tool windows is highlighted as a rectangular box to be positioned by dragging in any direction within the main window. Figure 3.4 is one example, but you can always rearrange these tool windows as you prefer to see them within your main software window.

3.2.2 Main Application

The main application window is divided into several major sections and dockable windows depending on the type of measurement selection. These windows can be arranged easily by docking and undocking within the main application display area.

3.2.3 Available Resources Window:

Sensors can be selected from the "Available Resources" window. A description for each connected resource will indicate the hardware version, model and channel information including alias. User can select up to eight resources per Virtual Power Analyzer. Following resource selection, click on "New Virtual Pwr Analyzer" and a new Virtual Power Analyzer instance will open with a default configuration suitable for pulse measurements.



Figure 3.5 Selecting a sensor using the Available Resources box

3.2.4 The Main Toolbar

Each Virtual Power Analyzer displays a Main Toolbar at the top of its window which hosts shortcuts to commonly used functions and measurements. The Main Toolbar is shown grouped; individual groups can be dragged to re-order or compact the toolbar.

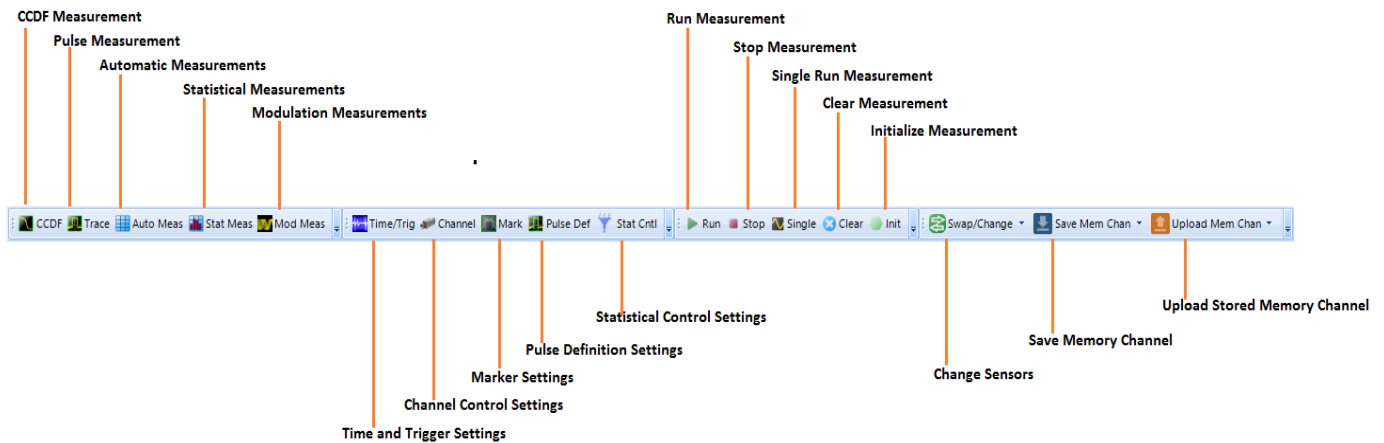
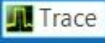

Figure 3.6 Main Toolbar Controls, shown grouped

3.2.5 Trace View Window

In order to display a pulse measurement, users must select the  icon from the Main Toolbar.



The  settings and  settings related to pulse measurement can be selected from Main Toolbar and can be applied to the measurement.



Figure 3.7 Use the Trace button on the Main Toolbar to display and setup a pulse measurement

A measurement window configuration suitable for pulse measurements is shown in Figure 3.8. This shows a large trace window, automatic measurements, and a tabbed control box for time and channel settings.

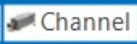
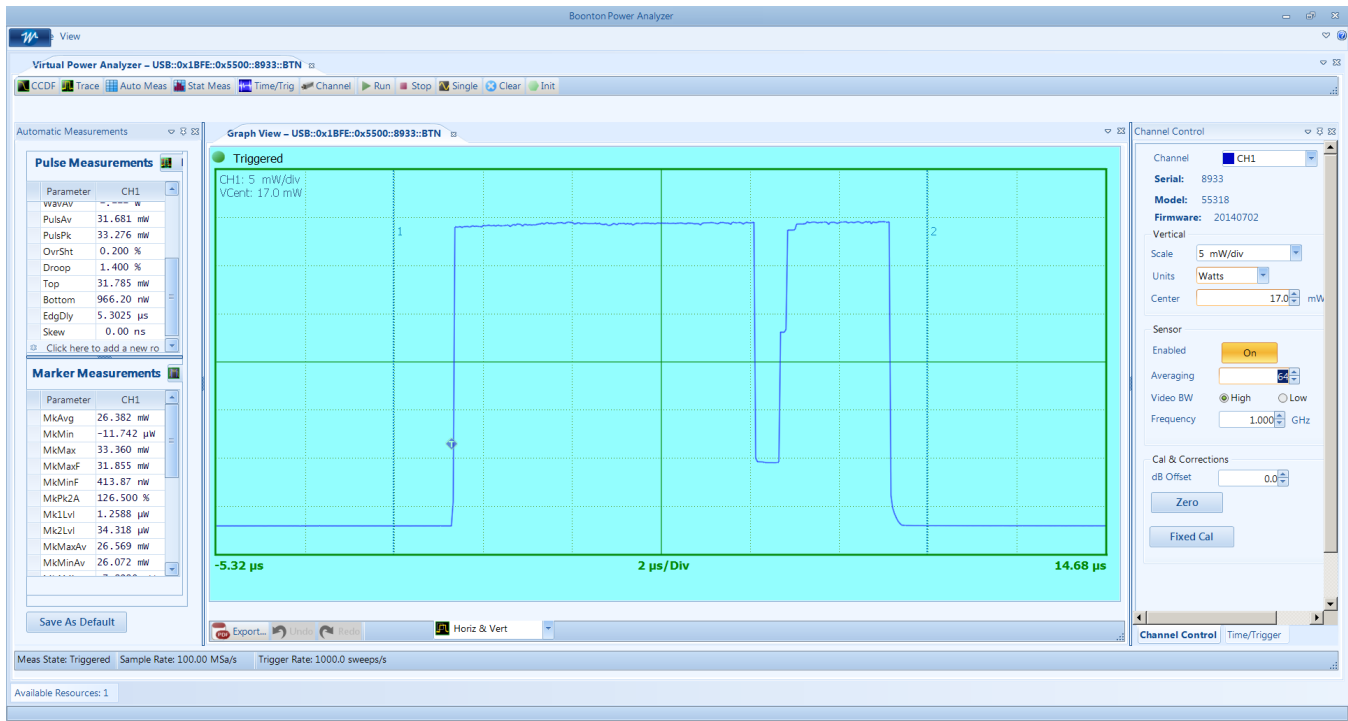

Figure 3.8 Main application window of the Power Analyzer Software.

The **Power Analyzer Software** allows the user to directly enter numeric values for most settings in the Channel Control and Time/Trigger windows. For many of the controls, additional methods such as increment/decrement or preset buttons are available.

Trace Pan and Zoom

The mouse can be used to select a zoom area to view detail in an area of interest on the displayed waveform. The highlighted dragged rectangular area indicates the minimum area that will be shown when the zoom operation completes.

Horizontal pan or zoom adjusts the timebase (within preset values) and the trigger delay to highlight an area of interest without vertical rescaling.

The user can also directly pan or zoom to waveform areas of interest by selecting any option from the lower toolbar of the trace window. Available options for zoom/pan control are: Horizontal & Vertical, Horizontal, Pan and None with Undo and Redo selections.

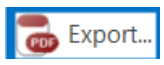

Figure 3.9 Clicking on the Trace View display and dragging will open a zoom box, releasing the mouse button will result in the trace being expanded to show the area contained in the zoom box

AutoSet

The  button below the trace window attempts to configure level scaling, trigger level and timing for a “best fit” display based upon amplitude and timing of the applied signal. All other parameters are set back to defaults. If the AutoSet process fails, all settings are left untouched.

Trace Data Export

Any trace window can be exported and saved or printed as a PDF or CSV document by selecting  button from the lower toolbar of the trace window. An exported trace file can easily be imported into a spreadsheet or other report file or documentation.

3.2.6 Channel Control Window

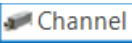
Select  icon and a dockable sidebar will appear on the right-hand side of the main application window by default. This allows you to change all related settings to control one or more sensor channels. Channel control setting is defined by several parameters as listed below.

Channel: Select one or all channels (for multi-channels) via the drop-down list. Selecting the "All" permits simultaneous update on all measurement channels (up to 8) for most settings.

Units: Selects dBm, Watts or Volts measurement units. Selection affects displayed text, measurements, and trace.

Vert Scale / Center: Sets vertical amplitude scaling and centering of the displayed waveform. These settings affect only the trace display.

Sensor Enabled: Enable or disable individual connected sensors.

Trace Avg: Sets number of acquired sweeps averaged together for displayed trace in pulse/triggered modes. Useful for noisy signals.

Mod Filter/Filter Mode: Sets manual or automatic filter integration time window for measurements in modulated (non-triggered) acquisition modes.

Peak Hold Mode/Decay Count: Sets peak hold duration (# of sweeps). Tracks Trace Avg setting or may be independent.

Video BW: Selects sensor video bandwidth, high or low.

Frequency: Sets measurement frequency for the applied RF signal.

Cal&Corrections: Offset compensates reading for external gain/loss.

Zeroing and Fixed cal: Sensor zeroing and fixed calibration can be performed by selecting each specific button.

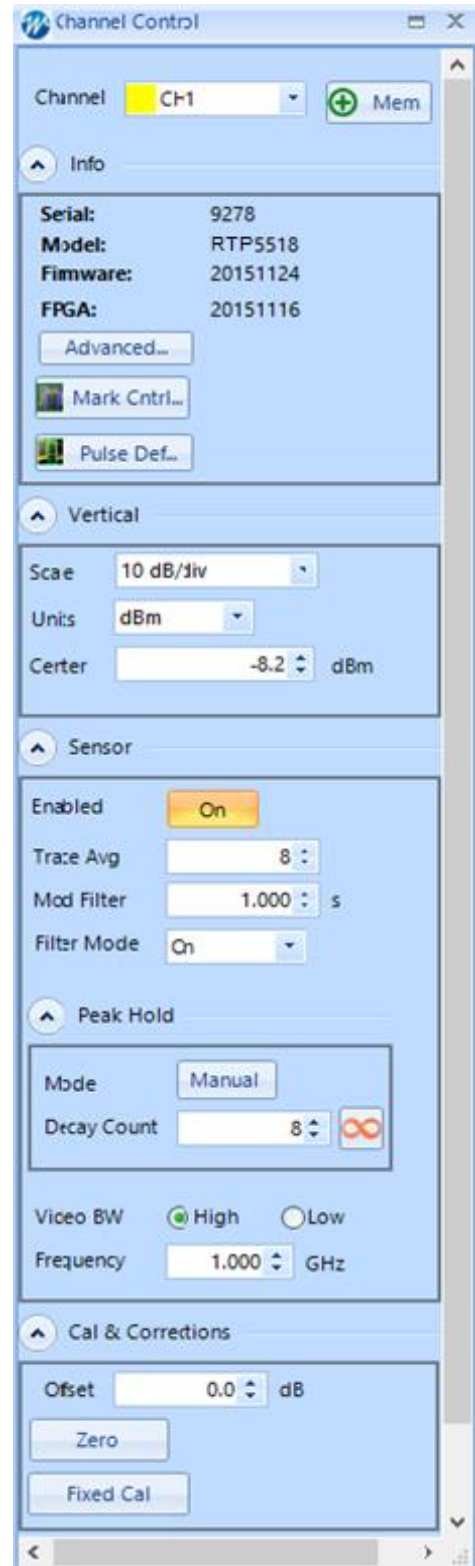
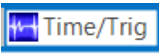

Figure 3.10 Channel Control Menu

3.2.7 Time / Trigger Settings Window

By selecting  icon you will be able to customize all related settings for both timebase and trigger of a pulse signal.

Timebase: Acquisition time in seconds per division. The power sensors use a fixed grid of 10 divisions for the sweep extents. Settings are in a 1-2-5 sequence. Consult series specifications for timebase range.

Trigger Delay: Trigger delay can be adjusted by manually entering a numerical value into the field or using the up-down arrow keys. Click the "0" icon to reset the trigger delay to zero seconds (RTP5000 only).

Trigger Position: Trigger position can be changed by entering numerical values into the "Divisions" field, clicking the scroll arrows, dragging the slide control, or by clicking the L/M/R (Left/Middle/Right) indicators.

Trigger Source: Several trigger modes are available for each trigger source under "Trigger Control" section. Multiple trigger sources are available under the drop-down list including both "Internal" and "External" selection.

Trigger Mode: Select Normal, Auto, AutoLevel or Free run.

Trigger Level: Sets trigger level when trigger source is INT and trigger mode is Auto or Normal.

Slope: Select rising or falling edge triggering.

Holdoff: Sets trigger holdoff time and selects between Normal or Gap holdoff mode.

Trigger Skew Adjustment: This feature allows the user to adjust the skew for internal trigger with master trigger output, and also external and slave triggers. Skew adjustments allow to calibrate out trigger delay between sensors so the user can measure propagation delay of the DUT from input to output. Manual skew adjustments can be made by entering the skew value in the numeric entry field. The button to the right of each skew adjustment is the Auto-Skew button which is described in detail in section 4.1.5. This feature allows automatic adjustment of the skew.

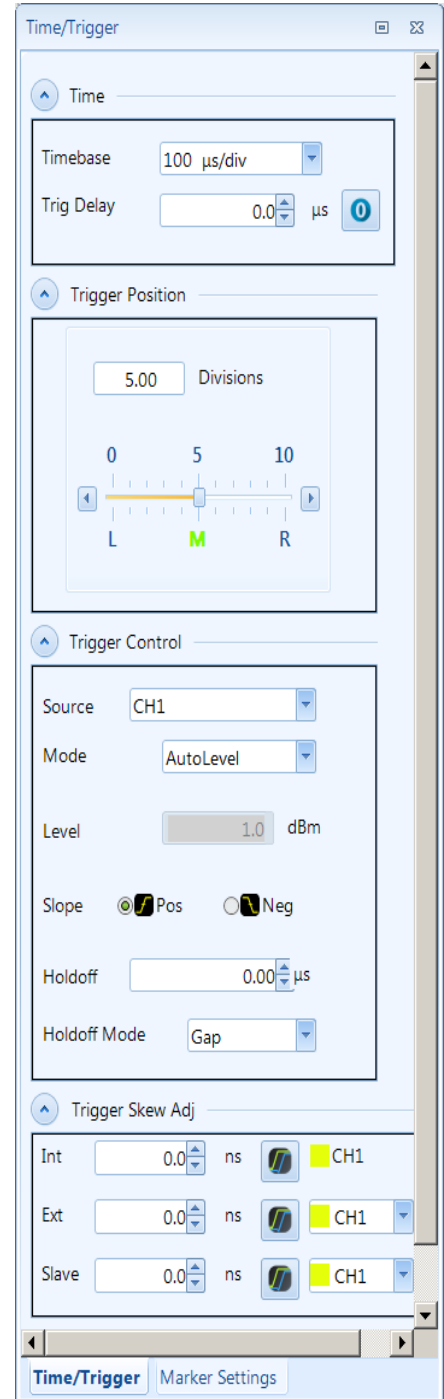
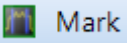

Figure 3.11 Time/Trigger Menu

3.2.8 Marker Settings Window

Clicking the  button will open a window to control settings for time markers and amplitude reference lines of a pulse signal.

Markers: Time Marker position settings will allow you to change both marker 1 and marker 2 time positions by using either arrow keys or entering numerical values into the field. It will also display the time delta value between the two markers.

Reference Lines: Also known as Horizontal Markers, can be enabled by selecting On/Off button for each individual channel. Once enabled, users may select several options for automatic amplitude tracking from the Tracking drop down list: Off, Markers, TopBottom, DistalMesial and DistalProximal. Two reference lines can be set by using up/down arrow keys. Horizontal markers are useful to determine the difference with regard to loss.

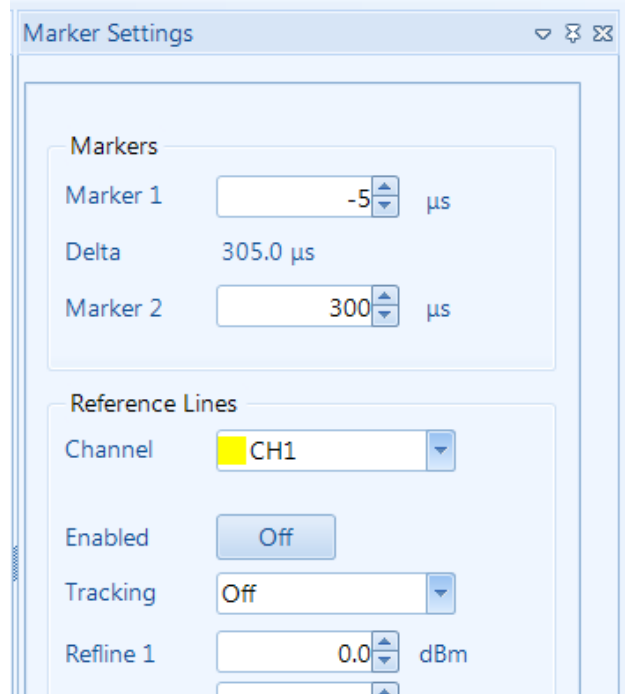

Figure 3.12 Marker Settings Menu

3.2.9 Pulse Definitions Window

Pulse Thresholds: Pulse definition setting allows user to define distal, mesial and proximal values for pulse thresholds. It is also possible to change pulse unit from watts to volts.

Pulse Gate: Pulse start and end gate can be changed both numerically and by changing up/down arrow keys.

Chapter 6 contains a detailed description of each pulse threshold level and the pulse measurement process.



Figure 3.13 Pulse Definitions Menu

3.2.10 Automatic Measurements Window

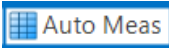
Selecting  icon will allow you to display a tabulated field with a list of parameters for RF pulse measurements including marker measurements. Below is an example screenshot for automatic parameters displayed for a typical pulse measurement.



NOTE: All field parameters are customizable, can be edited or deleted from the list. The whole table can be copied and pasted into a spreadsheet in order to make any custom report file along with captured screenshots by selecting export button as provided by the software.

Pulse Measurements 

Parameter	CH1
Width	20.000 μ s
Rise	-.--- s
Fall	-.--- s
Period	1.0000 ms
PRF	1.0000 kHz
Duty	2.000 %
Offtime	980.00 μ s
WavAv	-4.897 dBm
PulsAv	-.--- dBm
PulsPk	15.351 dBm
OvrSht	-.--- dB
Droop	-.--- dB
Top	12.071 dBm
Bottom	-30.093 dBm
EdgDly	355.01 μ s
Skew	0.00 ns
*Click here to add a new row	

Figure 3.14 A list of automatic parameters displayed for a pulse signal measurement.

Marker Measurements 

Parameter	CH1
MkAvg	-4.747 dBm
MkMin	-Low- dBm
MkMax	15.304 dBm
MkMaxF	12.109 dBm
MkMinF	-31.056 dBm
MkPk2A	20.051 dB
Mk1Lvl	-30.388 dBm
Mk2Lvl	-30.060 dBm
MkMaxAv	-4.738 dBm
MkMinAv	-4.759 dBm
Mk1Min	-Low- dBm
Mk1Max	-19.058 dBm
Mk2Min	-Low- dBm
Mk2Max	-17.894 dBm
MkRatio	-0.329 dB
MkDelta	0.224 dBm
MkRDelta	-0.224 dBm
MkRRatio	-0.224 dB
Mk1Time	-1.2850 ms

Figure 3.15 A list of marker measurements displayed for a pulse signal.

Customize Field Parameters:

All field parameters under automatic measurement are customizable, can be edited or deleted from the list by selecting individual parameter fields and then by using **right click** button of the mouse.

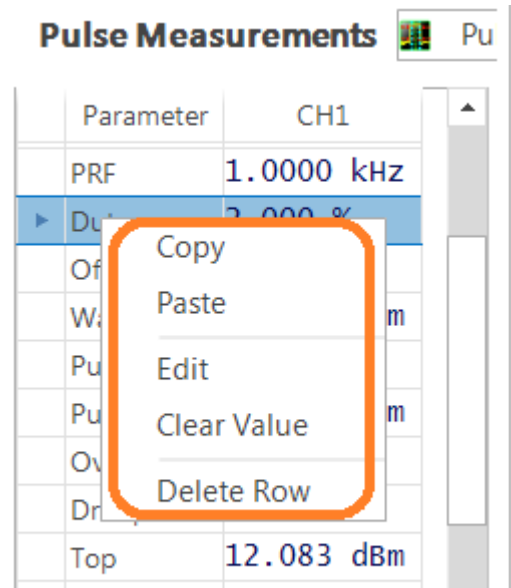

Figure 3.16 Right click on a parameter to access the edit pop up.

Export or Copy Field Parameters:

The whole automatic table or individual parameter field can be copied and then pasted into a simple spreadsheet or document in order to make a custom report file along with captured screenshots provided by the application.

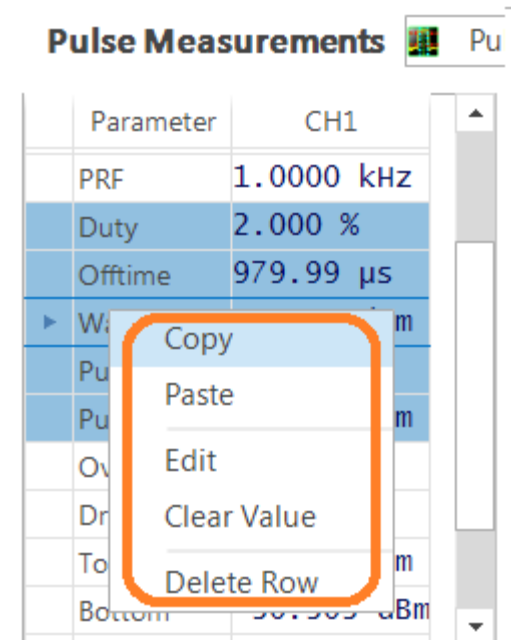

Figure 3.17 Select multiple parameters and right click to copy.

3.2.11 Display Settings Window

This option allows the user to customize data and trace colors for each measurement channel, and enable or disable trace display features such as **Average**, **Envelope**, **Maximum**, **Minimum** and **Persistence**. It is also possible to adjust marker color, background, grid colors and more under "Graph Colors" section of the display settings. *Note the Envelope, Min and Max settings have no effect when using RTP4000 models.*

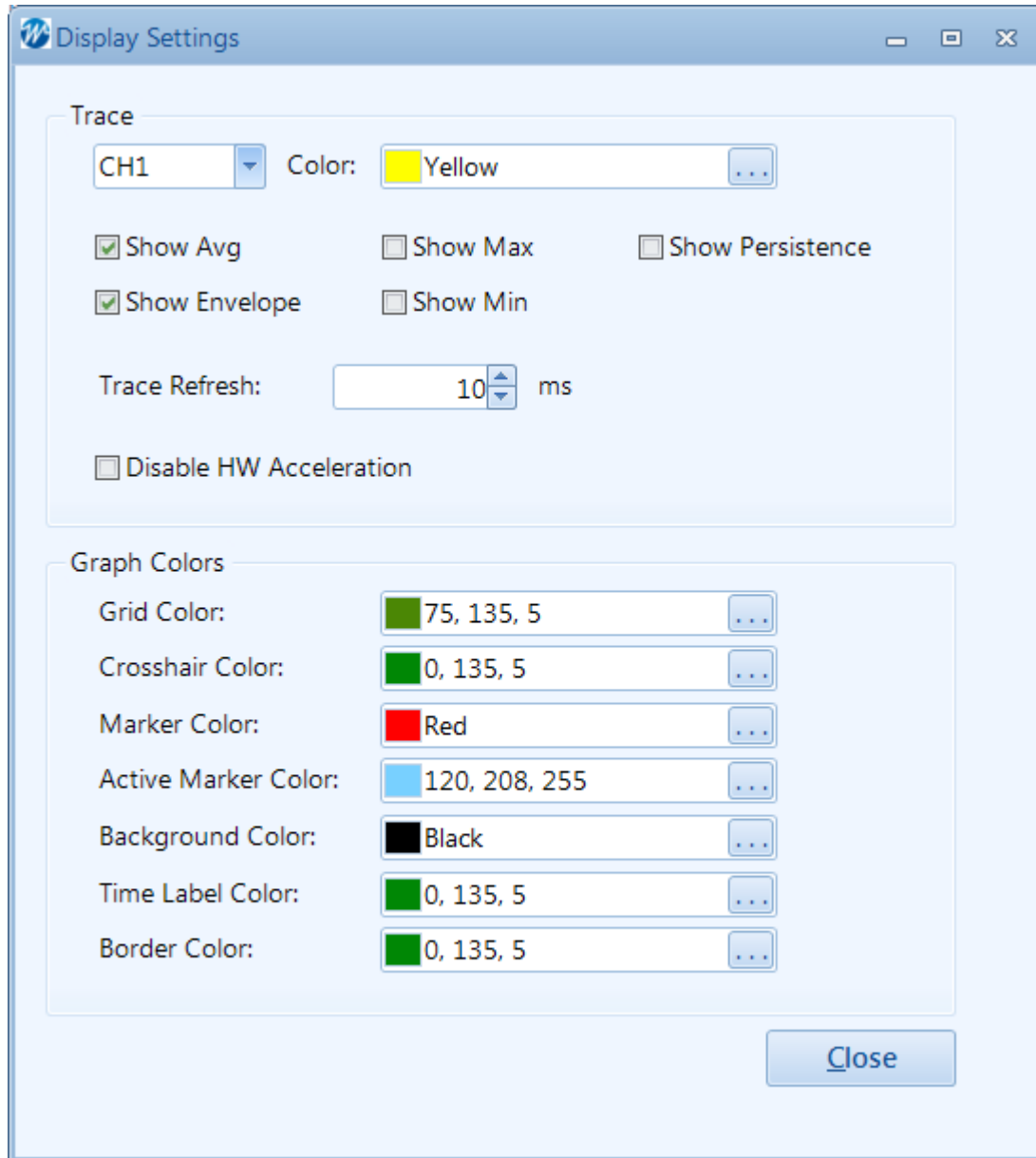



Figure 3.18 Use Display Settings to customize the display.

3.2.12 CCDF View Window (RTP5000 Only)

For statistical measurements, select the  icon from menu bar to view a CCDF graph. The sidebar on the CCDF screen allows adjustment of horizontal scale, horizontal offset, cursor type, cursor position and dB offset. The user can also enable/disable capture or reset the statistical data acquisition.

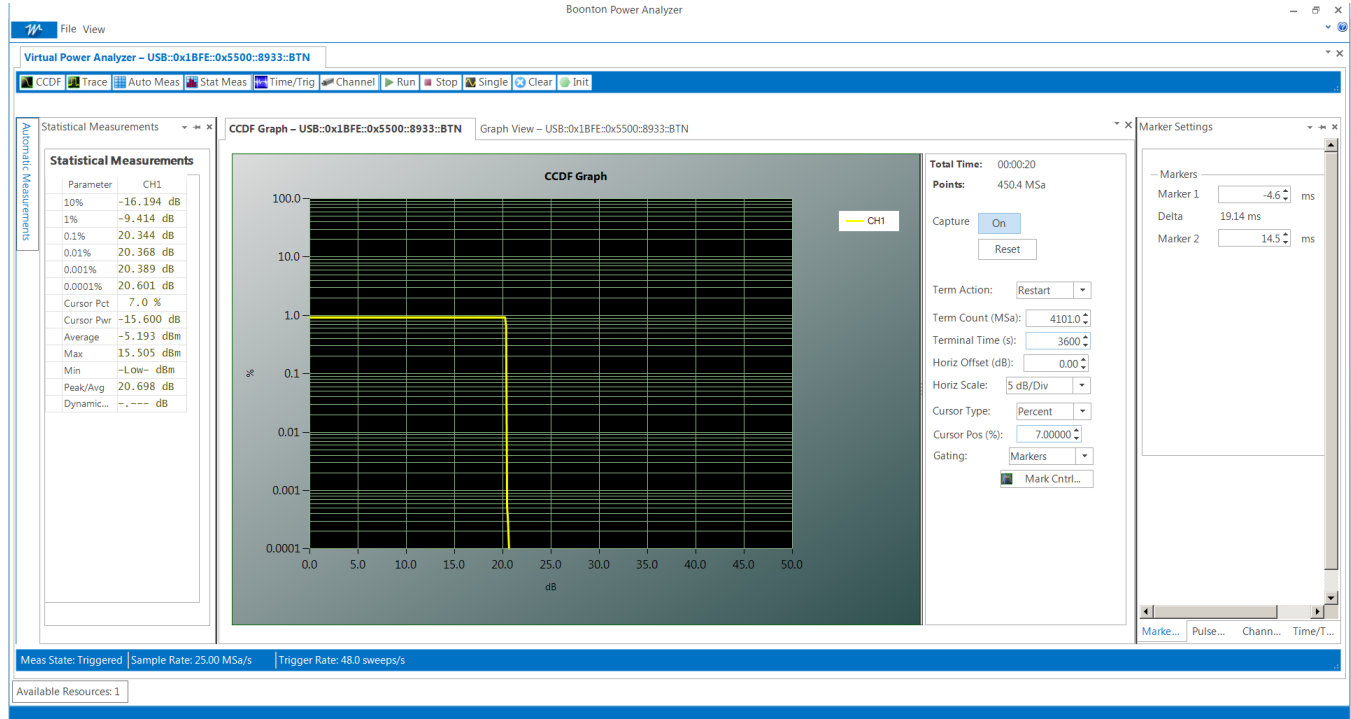



Figure 3.19 Complementary Cumulative Distribution Function (CCDF) graph is selected by pressing the CCDF button on the Main Toolbar

3.2.13 Statistical Measurements Window (RTP5000 only)

By selecting  icon, a tabulated list of statistical measurements will be displayed. Here is an example parameters text display for statistical measurements.

Statistical Measurements	
Parameter	CH1
10%	-23.249 dB
1%	11.649 dB
0.1%	11.676 dB
0.01%	11.696 dB
0.001%	11.893 dB
0.0001%	11.965 dB
Cursor Pct	19.02 %
Cursor Pwr	-25.400 dB
Average	3.493 dBm
Max	15.556 dBm
Min	-Low- dBm
Peak/Avg	12.063 dB
Dynamic...	-. --- dB

Figure 3.20 Statistical Measurements Window

This completes the introduction to the **Power Analyzer Software**. Chapter 4 provides a more detailed look at uses of the **Power Analyzer Software**.

THIS PAGE INTENTIONALLY LEFT BLANK

4. Operation

This section presents the procedures for operating the RTP Series Real-Time Power Sensors using the **Power Analyzer Software**. All the display windows that control the sensor are illustrated and accompanied by instructions for using each in the window.

4.1 Power Analyzer Software

The **Power Analyzer Software** is a Windows-based software program that provides immediate RF power measurements from RTP Series Real-Time Power Sensors without the need for programming on your Windows OS based computer. RF power measurements from the power sensor can be displayed on your computer or can be integrated into a test system using an Application Program Interface (API).



NOTE: This section of the manual assumes that the **Power Analyzer Software** has been installed on a computer using the instruction provided in the Getting Started Guide or Chapter 3 of this manual.

4.1.1 Initializing the Software

Open the **Power Analyzer Software** on the computer.

Use a mouse or other pointing device to click on the View tab on the top of the window.

Click on Load Defaults – this will load the default Windows Theme ‘Visual Studio 2012 Dark’ and will reset all application measurement settings to default values provide a known initial state.

Click on the down arrow adjacent to the theme to view the pull-down menu showing the available themes. The themes establish the look of the Windows environment setting colors, fonts, and backgrounds.

The balance of this chapter will use the ‘Default’ theme.

Click on any of the available themes to see what they look like. Select the theme you wish to use.

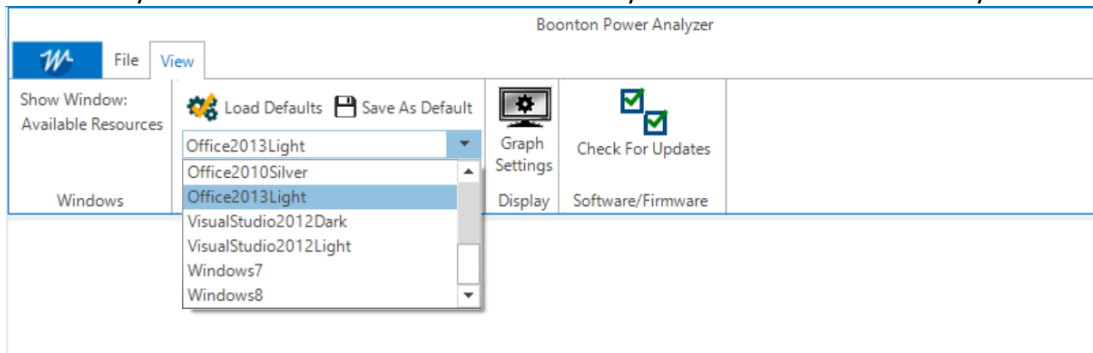

Figure 4.1 Selecting the Windows Theme using the Setting

4.1.2 Connecting the RTP Series Real-Time Power Sensor

Connect the RTP Series Real-Time Power Sensor to one of the USB ports of a computer using the supplied USB cable.

Connect power sensor to RF Source using the standard Type N or 2.9 mm connection port on the sensor.



- **CAUTION:** Do not turn the body of the sensor when connecting the sensor to a unit under test (UUT). To avoid internal sensor damage, connect and disconnect the sensor by turning the metal nut of the N connector only until it is 'hand tight'.
- **CAUTION:** Ensure that you do not apply any excessive force on the sensor once it has been connected.
- **CAUTION:** Do not exceed the specified RF power at the RF input of the sensor.

Once the power sensor is connected, a pop up box will appear in the **Power Analyzer Software** as in Figure 4.2 with the list of connected devices name and hardware information.

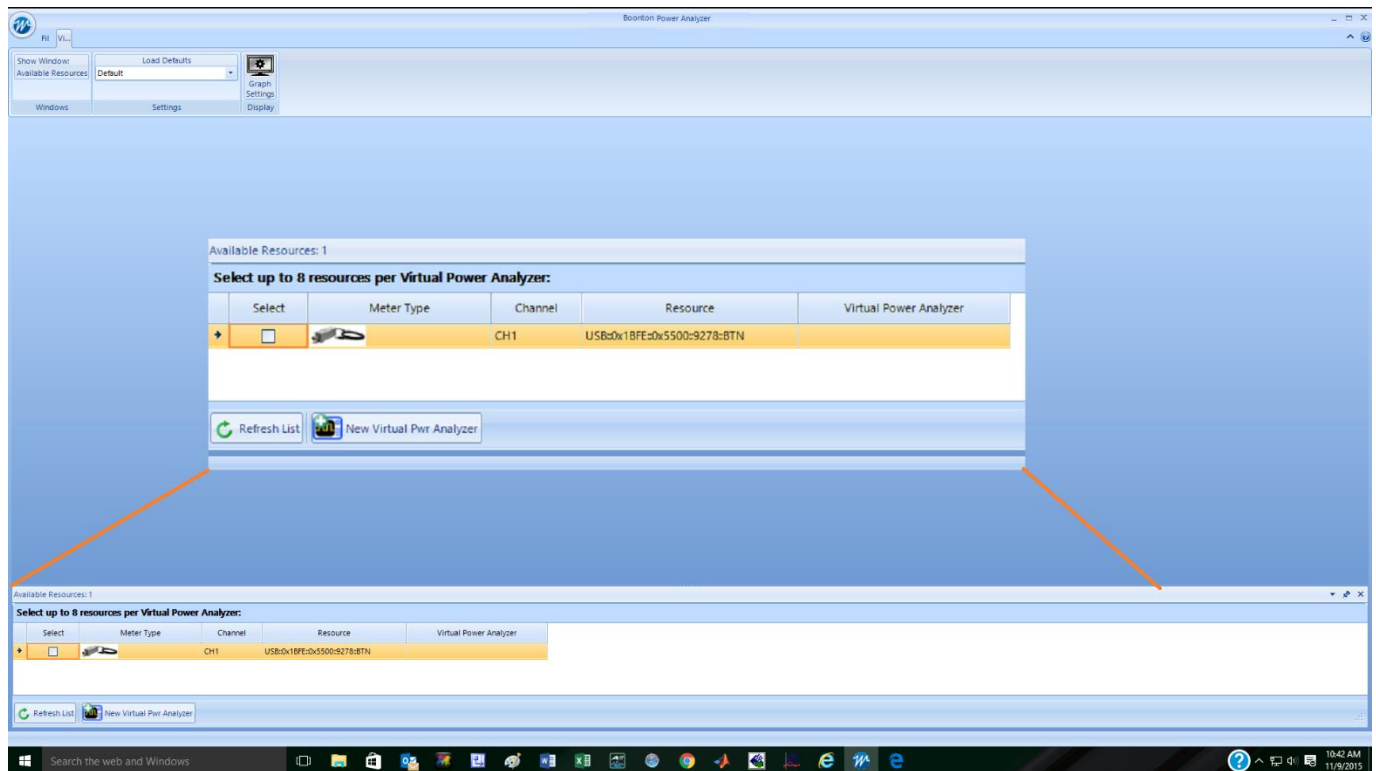

Figure 4.2 Once the power sensor is connected the software will list it as a resource in the **Available Resources** window.

Up to eight sensors can be connected to the software. Click on the "Select" box of one of the sensors, click "New Virtual Pwr Analyzer" button at the bottom, a new Virtual Power Analyzer window will show up. If you have an RF signal connected already to the power sensor, the measured signal should display in the Trace View window which appears along with the Channel Control tool window as shown in Figure 4.3.

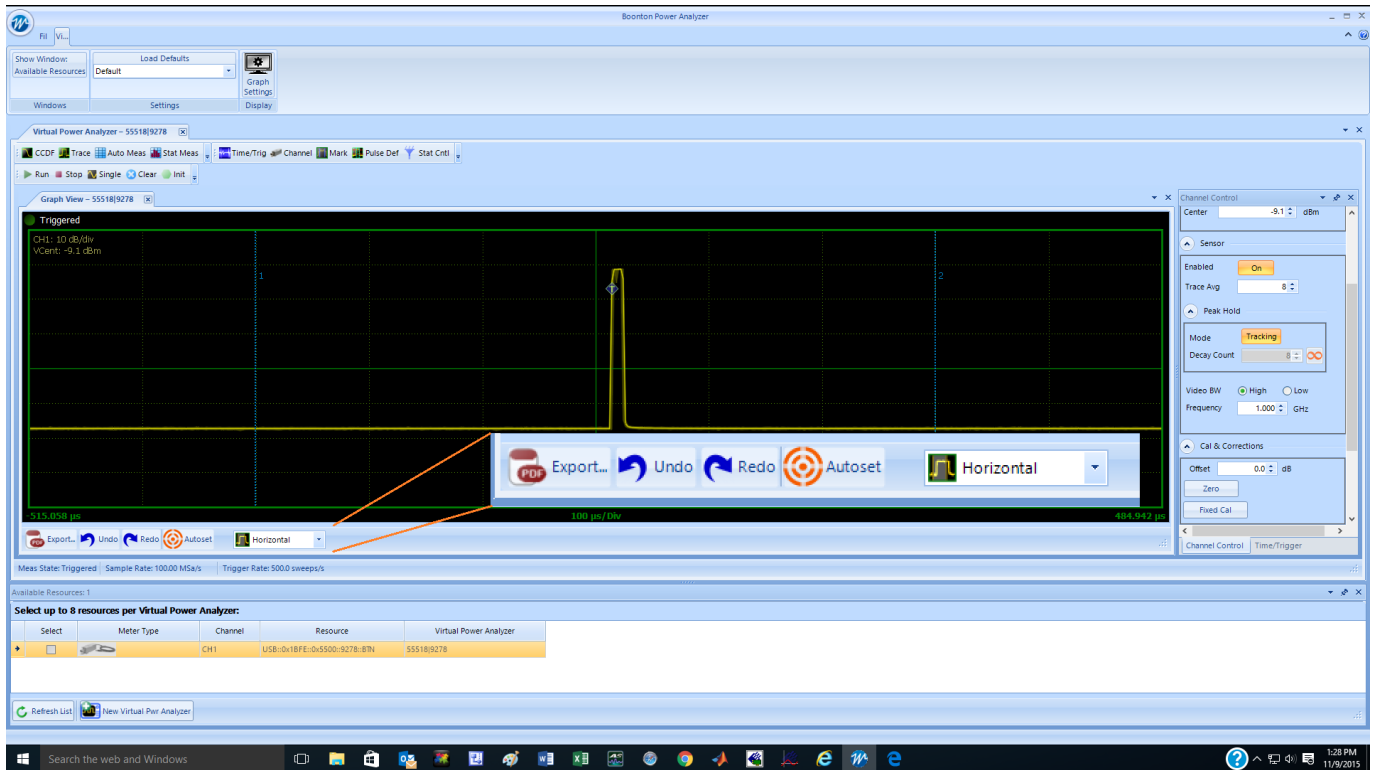

Figure 4.3 Upon selecting a sensor resource and pressing the New Virtual Pwr analyzer button the Graphical view of the power waveform will be displayed.

4.1.3 The Trace View Display

The Trace View window in Figure 4.3 displays a trace of power versus time. The readout in the upper left corner shows the channel number of the trace, the vertical scale factor and the vertical center. In Figure 4.3 Channel 1 is displayed with a vertical scale of 10 dB/div(ision) and a vertical center of -20 dBm.

The horizontal scale of the trace in the Trace View window is shown at the bottom of the grid. At the center of the horizontal axis is the horizontal scale factor. Numbers at the right and left ends of the horizontal axis show the trace start and end times relative to the trigger.

The two vertical blue lines labeled 1 and 2 are markers used for measurements of the displayed signals. These will be discussed later in the manual.

The bar at the bottom of the Trace View window provides a number of useful tools that can be used to optimize the trace display and archive the trace(s):

The **Export** button is used to export any trace window as a PDF or CSV document. These exported trace files can be used for a report or document.

The **Undo** and **Redo** buttons work in conjunction with the display expansion (zoom) function to remove (Undo) and restore (Redo) changes in display scaling.

Autoset provides an automatic setup of the trace display scaling which optimizes the trace view in the Trace View window.

The pull down menu box is used to select the zoom mode.

Horiz(izontal) & Vert(ical) lets the graphical drag and drop zoom control both horizontal and vertical expansion.

Horizontal limits the zoom controls to affecting the horizontal scaling only

Pan allows the user to click and drag the trace either horizontally or vertically.

None turns off both zoom and panning.

4.1.3.1 Trace Pan and Zoom

The application has a trace zoom feature which lets a user to drag a rectangular box (like the one shown in Figure 4.4) around the trace in order to zoom onto a special area of the displayed waveform. The highlighted dragged rectangular area indicates the minimum area that will be shown when the zoom operation completes. The zoom area is constrained to the preset timebase settings and trigger Vernier limits. Note in Figure 4.4 that the zoom horizontal scale changes from 10 $\mu\text{s}/\text{div}$ to 1 $\mu\text{s}/\text{div}$ the nearest available fixed timebase setting. Vertical scaling is similarly constrained.

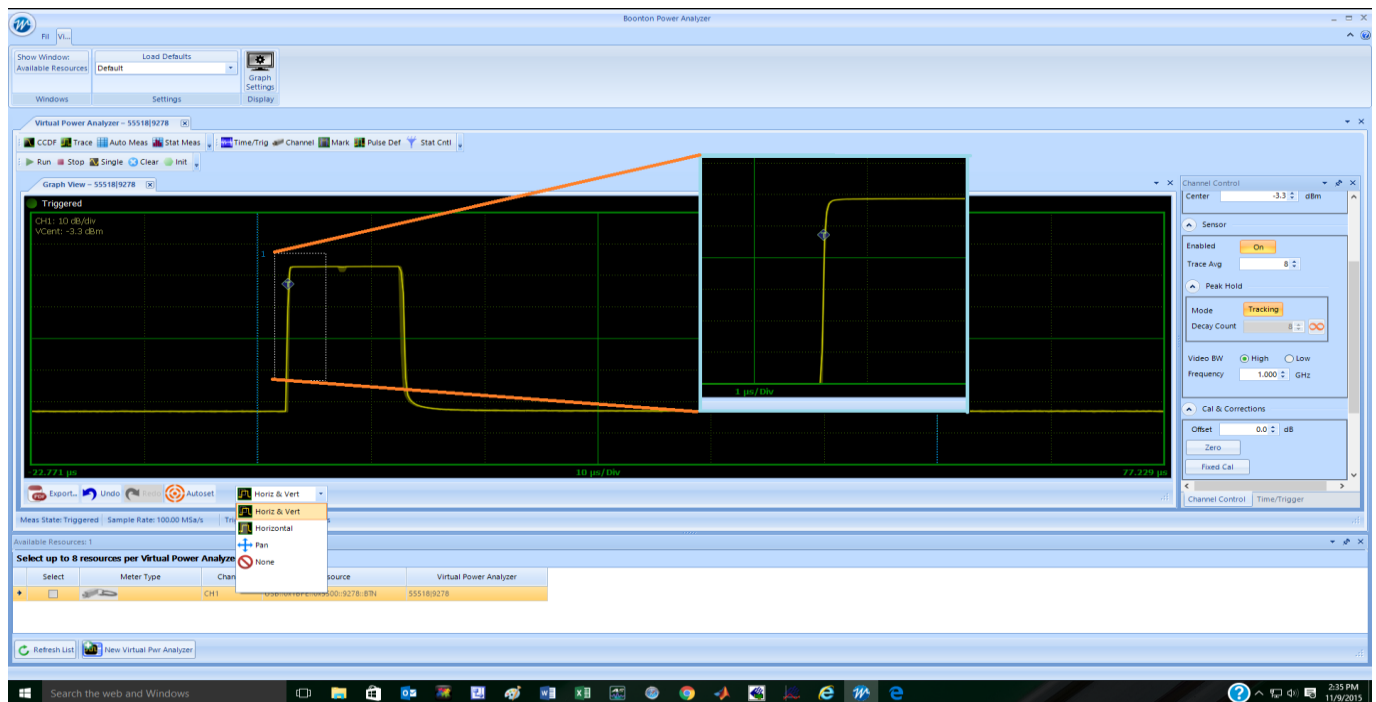

Figure 4.4 Horizontal or horizontal and vertical display expansion (zoom) is accomplished by clicking on the trace view and dragging the mouse diagonally while holding the mouse button down. A box will outline the area to be expanded. Releasing the mouse button will rescale the trace.

4.1.3.2 Formatting Trace View Display Settings

On upper left-hand corner click *View* (next to *File*) and then click Graph Settings icon. This will open the *Display Settings* popup as shown in Figure 4.5.

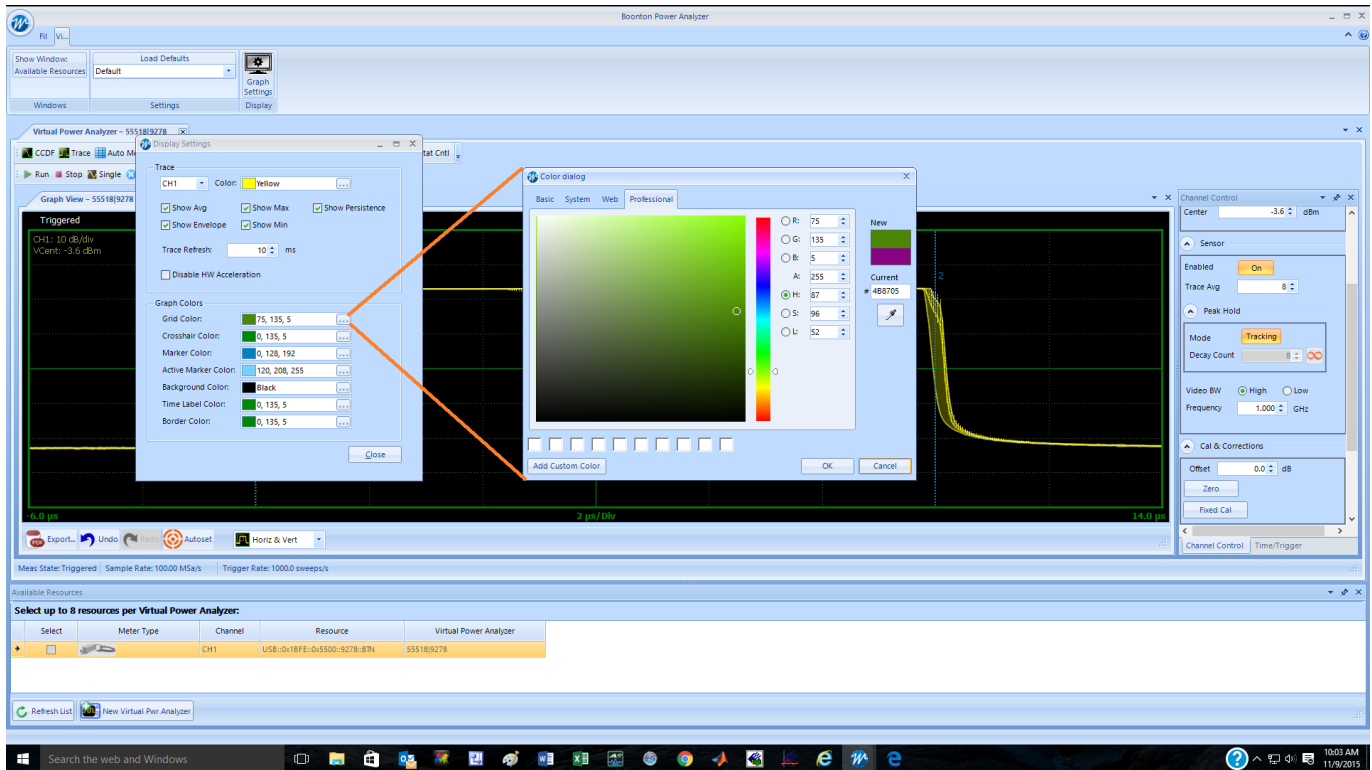

Figure 4.5 The Display Settings popup is used to configure the Graph View. The elements to be displayed can be chosen and their colors may be selected along with the background color.

The upper section of the Display Settings labeled Trace controls the configuration of the selected trace. There can be a maximum of eight traces. The configuration of each trace includes the trace color, the choice of five viewable trace attributes, and the trace refresh time. Trace attributes include graphical view of the average value, envelope, maxima, minima, and persistence (trace history). The defaults are to Show Avg and Show Envelope. Each of the selected elements is overlaid on the trace.



NOTE: The sensor acquires all three "traces" (average, min and max) when required for a RTP5000 sensor. These are used for several of the marker measurements such as interval peak-to-average, and others. For the marker intervals, Min and Max (highest maximum trace and lowest minimum trace points) as well as MinF and MaxF (min and max filtered) which are the highest and lowest points on the average trace. The former measurements are useful for looking at modulation, while the latter are most useful for seeing systematic peaks and dips (for example, ringing) of a repetitive waveform with the noise reduced. The RTP4000 sensor acquires the average trace only.

A check box for Disable HW Acceleration can be checked if the computer does not have a monitor or graphics card or if it is being operated remotely using remote desktop. Note: This change will not take effect until the next time a trace window is opened.

The lower section of the Display Settings popup provides controls for color choices for trace grid, border, and background. Markers, axis label, crosshair color selections are also included. Color choices are made by clicking on

the ellipsis symbol (...) adjacent to each element. This will bring up the Color Dialog palette used to set the desired color for the element

4.1.4 The Main Toolbar

The **Power Analyzer Software** always displays the Main Toolbar that is located at the top of the main program window and contains shortcuts to commonly used functions and measurements. The Main Toolbar can be customized as discussed below. Figure 4.6 shows the Main Toolbar:

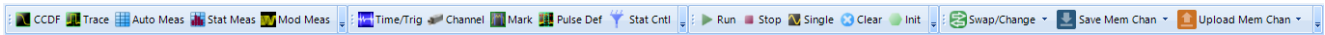

Figure 4.6 The main toolbar containing three sets of shortcuts to commonly used functions and measurements.

The Main Toolbar contains three sections called Toolstrips. The group of shortcuts on the left, including **CCDF**, **Trace**, **Auto Meas**(urement) and **Stat**(istical) **Meas**(urement) are the Measurement Windows Toolstrip and will bring up trace display or measurement windows. The middle group with **Time/Trig**, **Channel**, **Mark**, **Pulse Def**(initions) and **Stat**(istical) **Cntl**(Control) are the Control Windows Toolstrip, and will cause setup and control windows to be displayed. The final group including **Run**, **Stop**, **Single**, **Clear** and **Init**(ialize) are the Acquisition Control Toolstrip and affect the state of the acquisition.

Any of the toolstrips may be separated from the Main Toolbar and re-positioned by clicking on the ellipsis symbol at the left end of any of the groups and dragging the toolstrip.

The drop-down menu bar on the right of each section allows the user to edit the tools bar by adding or removing any of the items under the Items tab. The Toolstrips tab allows the user to show or hide the tools strips.

4.1.4.1 The Acquisition Control Toolstrip

The buttons on this toolstrip control the state of the acquisition:

Run – Starts the measurement acquisition and allows it to run continuously until stopped.

Stop – Stops the measurement acquisition.

Single – Starts a single measurement acquisition and then stops.

Clear – Erases the acquired data trace. Useful in clearing a single or averaged acquisition.

Init – Initializes or resets all settings for the active Virtual Power Meter to default values.

4.1.4.2 The Measurement Control Toolstrip

The buttons on this toolstrip create Trace View and CCDF Graph displays as well as the automated power measurement and statistical Measurement tabular display windows:

CCDF (RTP5000 only) – This button turns on the complementary cumulative distribution function (CCDF) display. If the CCDF display is already opened but hidden behind the Trace View display this button will bring the CCDF trace to the foreground.

Trace - This button turns on the Trace View trace that displays power versus time.

Auto Meas – This button opens Automatic Measurement windows showing the automatic Pulse and Marker Measurements tables.

Stat Meas (RTP5000 only) – This button opens the Statistical Measurements window displaying the measurements associated with the CCDF Graph.

4.1.4.3 The Control Windows Toolstrip

The buttons on this toolstrip control the setup windows for the acquisition, and measurement functions.

Time/Trig – This button displays the Trigger and Timebase control windows.

Channel – This button brings up the Channel Control Window allowing control of the vertical range and offset as well as sensor related settings

Mark – This button causes the Marker Settings window to be displayed. Marker and reference lines can be controlled from here.

Pulse Def – This button displays the Pulse Definitions window controlling the pulse measurement thresholds, units, and gating.

Stat Cntl (RTP5000 only) – This button brings up the Stat(istics) Mode Control window with scaling and population control for the CCDF display.

4.1.4.4 Memory Channel Toolstrip

The Memory Channel toolstrip contains **Swap/Change**, **Save Mem(ory) Chan(nel)**, and **Upload Mem(ory) Chan(nel)**, and controls the sensor connection source and saving and recalling Mem(ory) traces. The Memory Channel is a reference trace that appears on the Trace View when Mem+ is enabled.

Swap/Change - Swap/change allows you to change sensors for a particular session if more than one is connected.

Save Mem(ory) Chan(nel) – Saves the current Memory channel to a user selected folder on the computer.

Upload Mem(ory) Chan(nel) – recalls a stored Memory Channel to the Memory Channel Trace on the Trace View.

4.1.5 Time/Trigger Control Window

Pressing the Time/Trig button icon the Control Windows toolbar will bring up the Timebase / Trigger Control window shown in Figure 4.7.

This window has four sections **Time**(base), **Trigger Position**, **Trigger Control**, and **Trigger Skew Adj**(ust). Any of these sections can be opened or collapsed by clicking on the up/down arrow buttons to the left of the section titles.

Time and Trigger Position Controls

Settings in the Time and Trigger Position Control groups affect horizontal scaling and position of the acquired waveform.

Timebase controls the timebase or horizontal scale of the acquisition and is noted on the horizontal axis label of the Trace View. The Timebase pulldown menu permits selection of fixed timebase ranges from 5 ns/div to 50 ms/div (sensor series dependent) in a 1-2-5 progression.

Trig(ger) Delay can be adjusted either manually entering a numerical value into the field or using the up-down arrow keys.

The trigger delay time is set in seconds with respect to the trigger. Positive values mean that the trace display shows a time interval after the trigger event. This positions the trigger event to the left of the trigger point on the display, and is useful for viewing events during a pulse, or some fixed delay time after the rising edge trigger. Negative trigger delay mean that the trace display shows a time interval before the trigger event, and is useful for looking at events preceding the trigger edge.

Pressing the '0' button to the right of the trigger delay entry field resets the trigger delay to zero.

The range of trigger delay times is dependent on the timebase setting and is summarized in Table 4.1. Note the range will also depend upon the trigger position.

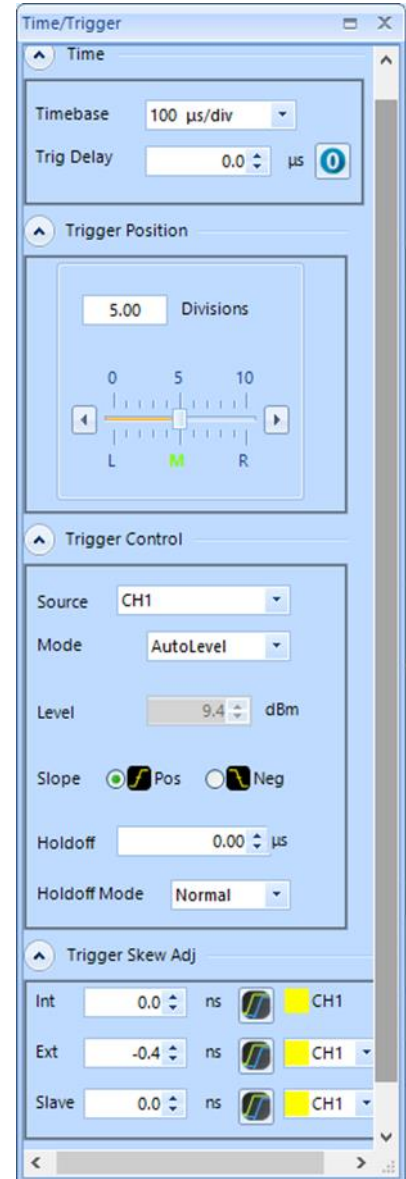

Figure 4.7 The Time/Trig Control window

Timebase Setting	Trigger Delay Range
5 ns/div to 10 us/div	-1.26 ms to 100 ms
20 us/div	-1.26 ms to 200 ms
50 us/ div	-5.04 ms to 200 ms
100 us/ div	-6.3 ms to 500 ms
200 us/div	-12.6 ms to 1
500 us/div	-31.5 ms to 1 s
1 ms/div	-63 ms to 1 s
2 ms/div to 10 ms/div	-126 ms to 1 s
20 ms/div	-252 ms to 1 s
50 ms/div	-628 ms to 1 s

Table 4.1

NOTE: Trigger delay ranges in Table 4.1 are for the trigger position set to 0 divisions (Left). If trigger delay and position settings result in a pre-trigger capture interval greater than 1.26 ms, the sensor will automatically reduce the sample rate to avoid overflowing its pre-trigger memory.



Trigger Position controls are used to set the location of the trigger point on the acquired trace waveform. It can be changed by entering numerical values into the Divisions field from -30 to +30 divisions, by positioning the horizontal slider bar, or by clicking on the **L**, **M** or **R** indicators to select one of three default positions: Left (zero divisions), Middle (five divisions) or Right (ten divisions).

Trigger Controls

Settings in the Trigger Control group provides control to affect the trigger source, mode, trigger level, slope, and trigger holdoff.

Trigger Source

The trigger source can be any of the resource channels (CH1, CH2, etc.), or the **Ext**(ernal) trigger input signal. The **Ind**(ependent) trigger setting allows each connected sensor to trigger independently from its own RF input.

The external trigger is attached to the RTP Series Real-Time Power Sensors via the Multi-I/O connector adjacent to the USB port on the RTP Series Real-Time Power Sensors. The connector is an SMB type. The external trigger requires a TTL signal level, minimum pulse width of 10 ns, and maximum frequency of 50 MHz.

In a multichannel set-up, the sensors can be triggered independently as described above or in a master/slave configuration. In master/slave configuration, one channel (CH1, CH2, etc.) is selected as the source (master) and the remaining sensors automatically operate in slave mode. See **multichannel mode** for additional information.

Trigger Mode

There are four available trigger modes: Normal, Auto, Autolevel, and Freerun.

Normal – The unit triggers when the amplitude of selected trigger source transitions above the preset trigger level when positive trigger slope is selected or if it transitions below the preset trigger level when negative trigger slope is selected. No automatic trigger actions take place.

Auto - Auto trigger mode operates in much the same way as Normal trigger mode, but will automatically generate a trace if no trigger edges are detected for a period of time. If a triggerable signal edge occurs during auto-trigger operation, the trigger system will resynchronize with the signal. For trigger rates below approximately 10 Hz, the Auto trigger time delay may interfere with resynchronization. Use Normal mode if this occurs.

AutoLevel - performs the same function as Auto and, in addition, automatically sets the trigger level based on the peak-to-peak amplitude of the signal. For many signals this will provide a fully automatic trigger system. For slow rate signals and complex level patterns, it may not produce the desired display. Use Normal mode if this occurs.

Freerun - Free Run generates horizontal sweeps asynchronously, without regard to trigger conditions. This mode is useful for locating low duty-cycle events visually.

Trigger Level

Sets the threshold level for the trigger signal in the Auto and Normal trigger modes. The trigger level can be entered numerically or changed by using arrow keys. The trigger level range has a maximum value of 20 dBm and a minimum range that is sensor model dependent (see the sensor specifications for your specific sensor model)

The trigger range is automatically adjusted to include the dB Offset parameter selected in the Cal & Corrections section of the Channel Control window. For example, if the trigger level = 10 dBm and the dB Offset is changed

from 0 to 20 dB, then the offset-adjusted trigger level will be displayed to the user as 30 dBm. Likewise, the maximum trigger level range will be extended to 40 dBm. The trigger level set point and setting range are both shifted upward by 20 dB

Trigger Slope

Sets the trigger slope or polarity. When set to Pos(itive), trigger events will be generated when a signal's rising edge crosses the trigger level threshold. When Neg(ative) is selected, trigger events are generated when the falling edge of the pulse crosses the threshold. Trigger slope can be selected by using Pos and Neg button boxes under slope.

Holdoff (Time)

The holdoff time can be entered and adjusted numerically to 0.01 μ s resolution, or using the up and down arrow keys in 1 μ s increments. The effect of Holdoff time depends on the Holdoff Mode. Set the trigger holdoff time in microseconds.

Holdoff Mode

There are two trigger holdoff modes: Normal and Gap.

Normal Holdoff

Normal trigger holdoff is used to disable the trigger for a specified amount of time after each trigger event. The holdoff time starts immediately after each valid trigger edge, and will not permit any new triggers until the time has expired. When the holdoff time is up, the trigger re-arms, and the next valid trigger event (edge) will cause a new sweep. This feature is used to help synchronize the RTP Series Real-Time Power Sensors with burst waveforms such as a TDMA or GSM frame. For periodic burst signals, the trigger holdoff time should be set slightly shorter than the burst or frame repetition interval.

Gap Holdoff

Gap or frame holdoff is very useful for packet-based communication signals where the transmission burst contains deep modulation which may fall briefly below the trigger threshold, or when bursts or pulses are of varying length and spacing, making normal holdoff ineffective. In most cases, the "off" time between transmission bursts, or frames, is considerably longer than the instantaneous modulation dips.

In gap holdoff the trigger is not armed until the trigger source remains inactive (below the trigger threshold for positive trigger slope, or vice versa for negative slope) for at least the set duration. So if trigger polarity is positive, and gap holdoff is set for 1 μ s, then the signal must stay below the trigger level for at least 1 μ s before the trigger is armed. Then, the next rising edge following a gap of 1 μ s or longer will trigger the acquisition.

Trigger Skew Adj(ust)

Trigger Skew aligns the edge crossing with the trigger point for each of the trigger sources. This is done internally by adding a trim value to the trigger delay setting. Since the different trigger sources (internal, external, and slave) have different delays, the system stores a value for each.

Trigger Skew requires a fast RF pulse ($T_{rise} < 10$ ns) to adjust 'Int' skew. To auto-adjust 'Ext' requires a fast RF pulse aligned with a fast external trigger pulse applied to the sensor's MIO input. Adjusting the 'Slave' source requires two sensors connected to a common, fast RF pulse ($T_{rise} < 10$ ns) and interconnected for cross-trigger via their MIO inputs. You can de-skew one setting at a time until all three sources are calibrated.

Deskewing can be done automatically by clicking on the double slope icon on the left of “ns”, shown in Figure 4.8. Automatic deskewing requires a fast edge, repetitive signal.

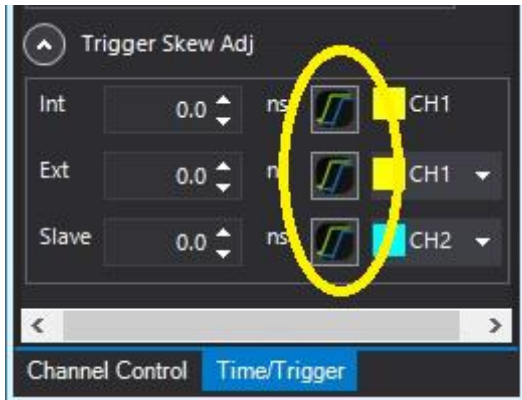

Figure 4.8 The automatic deskew icons.

4.1.6 Channel Control Window

The Channel Control window allows you to change all related settings to control sensor channels. The **Power Analyzer Software** has the capability of handling multiple control channels by selecting each individually from the drop-down list. Channel control setting is defined by several parameters as listed below:

Channel

You can select an individual channel or all measurement channels (for multi-channel operation) by using the drop-down list. The channel labeled **MEM1** is a memory channel which is a reference trace that can be stored or recalled as need.

The **⊕ Mem** button causes the current trace to be stored in the Memory Channel. The current memory channel can be stored to the computer hard drive using the **Save Mem Chan** button in the Memory channel toolstrip. Likewise, a previously stored memory trace can be recalled using the **Upload Mem Chan** button.

To turn off the Memory Channel, select MEM1 or MEM2 from the Channel drop down menu, then click on the “On” button next to "Enabled" in the **Sensor** menu (see below) to select “Off”.

Info

The **Info** group shows the pertinent information for the selected sensor. Sensor model number, serial number, and firmware and FPGA versions for the selected channel are displayed in this group.

Pressing the **Advanced** button will result in a **Sensor Info** popup with three tabs: Sensor Data, Cal Factors, and Hardware Info.

Sensor Data contains identification and calibration information for the sensor.

Cal Factors contain the frequency response calibrations factors for both high and low bandwidth calibration.

Hardware Info contains information on the current state of the sensor hardware including the detector temperature and key power source voltage readings.

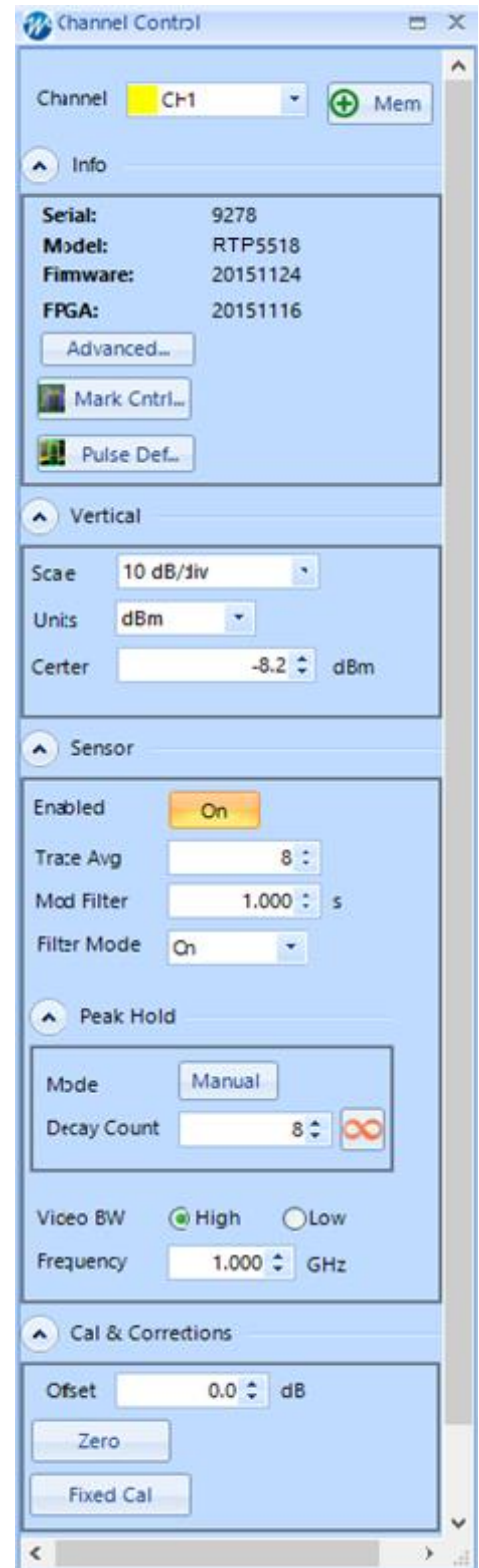

Figure 4.9 Channel Control Window

Vertical

The Vertical group contains controls that affect vertical settings for the selected power sensor.

Scale - Vertical scale sets the scaling of the level axis of the Trace View based on the selection of units as shown in Table 4.2.

Units	Scale
dBm	0.1, 0.2, 0.5 1, 2, 5, 10, 20, 50 dB/div
Watts	1 pW to 500 MW/div in a 1-2-5 progression
Volts	1 μ V to 100 kV/ div in a 1-2-5 progression

Table 4.2 Vertical Scale range for each Units setting

Units - The trace presentation may be shown in units of dBm, Watts or Volts. The Units selection determines the range of the scale values. Note that the Units setting also affects text measurement values in the Measurement windows.

Center - Set the power or voltage level of the horizontal centerline of the graph for the specified channel in the selected channel units. The center position can be entered numerically or adjusted by using up and down arrow keys.

Sensor

The Sensor group controls acquisition parameters for the selected power sensor.

Enabled - Individual sensors or all the selected sensors can be enabled or disabled by using the alternate action On/Off button. This functionality also enables or disables the MEM channels.

Trace Avg – Trace averaging can be used to reduce display noise on both the visible trace, and on automatic marker and pulse measurements. Trace averaging is a continuous process in which the measurement points from each sweep are weighted (multiplied) by an appropriate factor and averaged into the existing trace data points. In this way, the most recent data will always have the greatest effect upon the trace waveform, and older measurements will be decayed at a rate determined by the averaging setting and trigger rate. This averaging technique is often referred to as ‘exponential’ averaging because averaging imposes a first-order Infinite Impulse Response (IIR) exponential filter with a time constant of "n" where n is the Trace Avg (number of averages) setting.

Sensor averaging can be set by selecting a number of averages from 1 (no averaging) to 16384 in binary steps using the up and down arrow buttons in the Trace Avg field.



NOTE: For timebase settings of 200 ns/div and faster, the sensor acquires samples using a technique called equivalent time or random interleaved sampling (RIS). In this mode, not every pixel on the trace gets updated on each sweep, and the total number of sweeps needed to satisfy the average setting will be increased by the sample interleave ratio of that particular timebase. At all times the average trace is the average of all samples for each pixel, and the min/max are the lowest and highest of that same block of samples for each pixel.

Mod Filter sets the modulation filter integration time. It is used in modulated mode measurements and does not affect the pulse mode (triggered) measurements shown in the trace view. The modulation filter is a “sliding

window” filter which averages samples taken within a time window whose duration is set by this field. All samples within the time window are equally weighted.

Filter Mode controls the modulation filter. The filter can be set to **On** (manual filter time setting), **None** (integration time is set to the minimum 1 ms value), or **Auto** (integration time automatically selected based upon input level).

Peak Hold (RTP5000 only) settings control the operating mode of the selected channel’s peak hold function. Peak Hold affects the envelope trace (if displayed) as well as peak or dynamic range marker and pulse measurements.

In **Tracking** mode the maxima and minima traces “decay” towards the average with a time constant that is the same as the averaging setting. If averaging is set fast (Trace Avg is set to a low value), then the maxima and minima decay quickly (are not held very long) while long averaging (Trace Avg is set to a high value) settings yields a ‘flatter’ trace and maxima and minima peaks decay slowly back to the average power level.

In **Manual** mode the averaging and peak time constants are independent (do not track each other). Rather, peaks are held for a time proportional to the **Decay Count** setting. Decay Count can be set from 1 to 16384 and increments in binary steps.

Manual mode can be useful if you want to set averaging short to see short-term signal fluctuations from one trace to the next, yet want the peaks held for a long time to get a better feel of longer-term peak stress on your system.

The **Infinite Hold** button sets the Decay Count to infinity. Signal peaks and dips are held indefinitely and never decayed. This is useful for long-term monitoring for glitches, spikes, dropouts, or other intermittent signal events.



NOTE: *The effects of the peak hold, i.e. min/max decay, are only visible when the “envelope” or “min/max” display is enabled in the view options (See paragraph 3.3.11 and the associated Figure 3.18). However, marker min/max values are always affected.*

Video BW sets the sensor video bandwidth for the selected sensor. High is appropriate for most measurements, and the actual bandwidth depends upon the sensor model. Low bandwidth offers additional noise reduction for CW or signals with very low modulation bandwidth. If Low bandwidth is used on signals with fast modulation, measurement errors may result if the sensor cannot track the fast-changing envelope of the signal.

Frequency should be set to the RF frequency that is applied to the sensor for the current measurement. The appropriate frequency calibration factor from the sensor’s calibration table will be interpolated and applied automatically. Application of this calibration factor compensates for the effect of variations in the flatness of the sensor’s frequency response.

The power sensor has no way to determine the carrier frequency of the applied signal, so the user must always enter the frequency.

Cal & Corrections

The Calibration and Corrections group controls coarse and fine corrections to the measurements.

Offset - Sets a measurement offset in dB for the selected sensor. This is used to compensate for external couplers, attenuators or amplifiers in the RF signal path ahead of the power sensor.

Zero - Performs a zero offset null adjustment. The sensor does not need to be connected to any calibrator for zeroing. This action removes the effect of small, residual power offsets, and should be performed prior to low-level measurements. Note that there should be no RF signal applied to the sensor input prior to zeroing.

Fixed Cal - Performs a calibration at 0 dBm at the currently set frequency. This requires a calibrated 0 dBm (1.00 mW) signal source at the current measurement frequency.

4.1.7 Automatic Measurements Display

Clicking on the **AutoMeas** icon in the Measurement Control Toolstrip will bring up the Automatic Measurements window to the left of the Trace View as shown in Figure 4.10. This window includes two related sub-windows, Pulse Measurements and Marker Measurements. The Pulse Measurements window shows the sixteen default field pulse parameters. The field pulse parameter measurements are computed with methods described in **IEEE Std 181™-2011** and detailed in Section 6 on pulse terms and definitions.

The Marker Measurements window shows twenty one marker measurements.



NOTE: All field parameters are customizable, can be edited or deleted from the list by selecting individual parameter fields and then by using right click button of the mouse. The whole

table can be copied and pasted into a spreadsheet in order to make any custom report file along with captured screenshots by selecting export button as provided by the software.

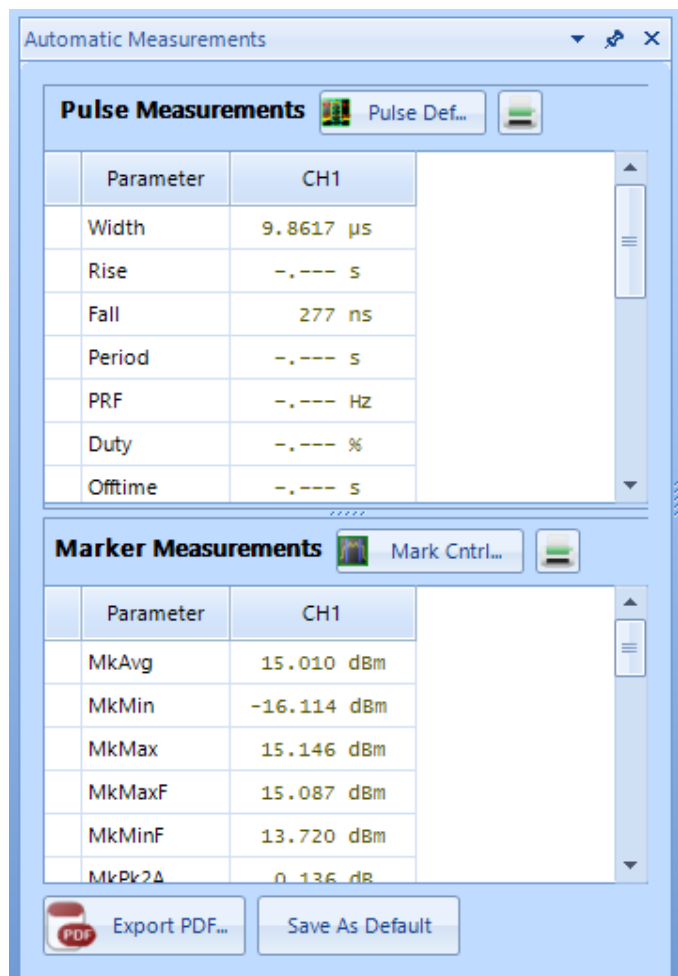

Figure 4.10 The Automatic Measurements window containing the Pulse and Marker Measurements tables.

Any individual parameter or group of parameters on pulse or marker measurements can be highlighted by left clicking with the mouse and using the up and down arrow keys a group of them can be selected. Selected cells can be copied by right clicking on the parameter(s) and selecting copy. The copied cells can be pasted into a spreadsheet or document.

Clicking on the printer icon next to either table will open a Print Preview window allowing the user to print the table.

Clicking on the **Export** button will open a viewer showing the whole table. The contents of the viewer can be saved or printed as PDF or CSV files if desired.

4.1.8 Pulse Definitions Window

Clicking on the **Pulse Def** button in the Pulse Measurement title bar or on the **Pulse Meas** button on the Measurement Control Toolstrip will open the Pulse Definitions window shown in Figure 4.11. This window contains the pulse thresholds, pulse analysis units and gate settings for the selected sensor.

Pulse Thresholds

Pulse definition settings allows user to define distal, mesial, and proximal values for pulse thresholds, and the pulse units.

Distal - Sets the pulse amplitude percentage that defines the end of a rising edge or beginning of a falling edge transition. Typically, this is 90% voltage or 81% power relative to the top level of the pulse. This setting is used when making automatic pulse risetime and falltime calculations.

Mesial – Sets the pulse amplitude percentage that defines the midpoint of a rising or falling edge transition. Typically, this is 50% voltage or 25% power relative to the top level of the pulse. This setting is used when making automatic pulse width and duty cycle calculations.

Proximal – Sets the pulse amplitude percentage that defines the beginning of a rising edge or end of a falling edge transition. Typically, this is 10% voltage or 1% power relative to the top level of the pulse. This setting is used when making automatic pulse risetime and falltime calculations.

Pulse Units – Controls whether the distal, mesial, and proximal thresholds are computed as voltage or power percentages of the top/bottom amplitudes. If Volts is selected, the pulse transition thresholds are computed as voltage percentages, and if Watts, they are computed as power percentages.

Many pulse measurements call for 10% to 90% voltage (which equates to 1% to 81% power) for risetime and falltime measurements, and measure pulse widths from the half-power (–3 dB, 50% power, or 71% voltage) points. The Pulse Units setting is independent of the channel’s display units setting.

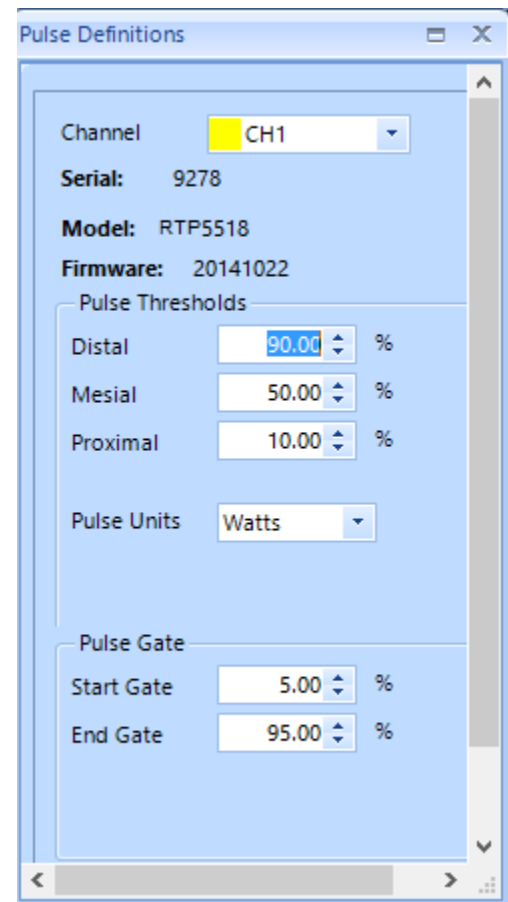

Figure 4.11 The Pulse Definitions window for setting measurement thresholds, units, and gate locations.

Pulse Gate

The Pulse Gate settings define the measurement interval for the following power related pulse measurements: Pulse Average, Pulse Peak, Pulse Minimum and Pulse Droop/Tilt. Pulse timing measurements between mesial crossings such as width and period are not affected. The purpose of the Pulse Gate setting is to exclude edge transition effects from the pulse power measurements. Automatic pulse measurements are then performed between Start Gate and End Gate points.

Start Gate - Sets the beginning of the pulse measurement region as a percentage of the pulse width. The Start Gate has a continuous range of 0.0 % to 40.0 % of the pulse width and may be entered numerically or varied using the up or down arrows.

End Gate - Sets the end of the pulse measurement region as a percentage of the pulse width. The End Gate has a continuous range of 60.0 % to 100.0 % of the pulse width and may be entered numerically or varied using the up or down arrows.

4.1.9 Marker Settings Window

Clicking on the **Mark Ctrl** button in the Marker Measurement title bar or on the **Mark** button on the Measurement Control Toolstrip will open the Marker Settings window shown in Figure 4.12. This window contains vertical marker locations, marker delta, and horizontal reference line locations for the selected sensor.

Markers

Time Markers are a pair of vertical cursors that allow level measurements at specific times relative to the trigger event. Markers can be moved to any portion of the trace that is visible on the screen, and these can be used to identify regions of interest for detailed power analysis. Power measurements can be performed at each marker, as well as average, minimum and maximum power in the time interval between the two markers.

Marker 1 and Marker 2

Marker settings will allow you to change both marker 1 and marker 2 positions by using either arrow keys or entering numerical values into the field. The Marker locations can also be set graphically by clicking on the marker in the Trace View and dragging the marker left or right.

Marker Delta

The Marker Delta window indicates the time interval between Marker 1 and Marker 2.

Reference Lines

Reference lines Refline 1 and Refline 2 are horizontal lines displayed on the Trace View, and may be used to indicate user set amplitude levels for each sensor, or measurement-specific levels.

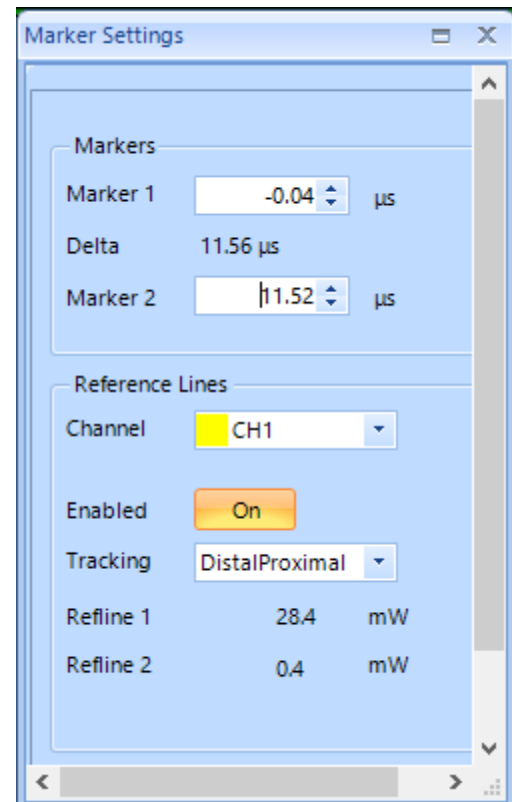

Figure 4.12 The Marker Settings window for controlling markers and reference lines on the Graph View

Channel

Selects the channel that the reference lines will be applied to.

Enabled

Turns the reference lines on or off for the selected channels. When off, reference lines are not visible.

Tracking

The Reference Line Tracking setting allows the selection of either manual control of the reference line amplitudes or selection of a set of commonly used reference amplitudes.

Off – Allows the reference levels to be set independently using the Refline 1 and Refline 2 entry fields. Levels can be entered numerically or by using the up and down arrows. The reference levels can also be set graphically by clicking on the reference line in the Trace View and dragging the line up or down. The vertical units match the Units selection in the Channel Control window.

Markers – Links the reference levels to the amplitudes where the markers cross the pulse waveform on the Trace View. Reference level Refline 1 will track the amplitude where Marker 1 crosses the pulse waveform and Refline 2 will track the amplitude where Marker 2 crosses the pulse waveform.

TopBottom – Moves Refline1 to the measured Top amplitude and Refline 2 to the measured Bottom amplitude.

DistalMesial - Moves Refline 1 to the measured distal (upper pulse threshold) amplitude and Refline 2 to the measured mesial (mid pulse threshold) amplitude. Pulse threshold levels are those set in the Pulse Definitions window.

DistalProximal - Moves Refline 1 to the measured distal (upper pulse threshold) amplitude and Refline 2 to the measured proximal (lower pulse threshold) amplitude. Pulse threshold levels are those set in the Pulse Definitions window.

4.1.10 Statistical CCDF Graph Display (RTP5000 only)

The statistical analysis of the current sample population is displayed using a normalized Complementary Cumulative Distribution Function (CCDF) presentation shown in Figure 4.13. The CCDF expresses the probability of occurrence of a range of peak-to-average power ratios on a log-log scale, and a cursor (green diamond) allows measurement of power or percentage at a user-defined point on the CCDF. As with all other graphical displays, the trace can be easily scaled and zoomed, or the statistical data may be presented in a tabular format.

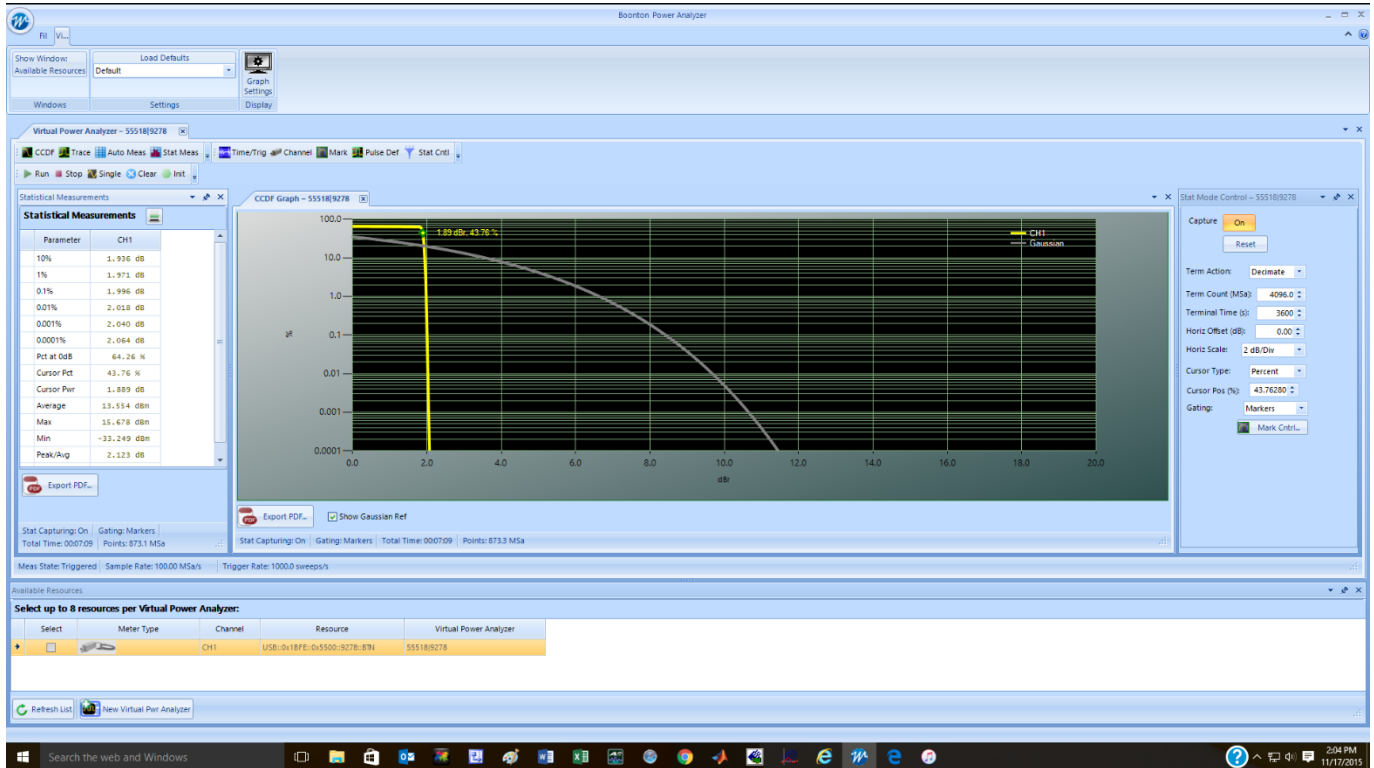

Figure 4.13 The CCDF Graph view provides a statistical view of the peak-to-average power ratio.

The CCDF has become a useful tool for analyzing communication signals that have a Gaussian like distribution (CDMA, OFDM) where signal compression can be observed at rarely occurring peaks. It is most often presented graphically using a log-log format where the X axis represents the relative offset in dB from the average power level and the log-scaled Y axis is the percent probability that power will exceed the X-axis value.

At the bottom of the CCDF Graph window is a status bar reporting Stat Capturing status (On or Off), Gating type (Markers or Freerun), Total Time (HH:MM:SS) and the number of Points (MegaSamples) in the statistical population.

Additionally, there is an Export button and a Show Gaussian Ref check box. Clicking on the Export button will bring up a Viewer popup window offering the ability to export the CCDF Graph in PDF or CSV format. Actuating the **Show Gaussian Ref** displays a Gaussian CCDF reference curve on the graph, as shown in Figure 4.13.

4.1.11 Statistical Mode Control Window (RTP5000 only)

The **Stat Mode Control** window, shown in Figure 4.14, will appear when the CCDF Graph is displayed or by pressing the **Stat Ctrl** button on the Control Windows toolbar. The Stat Mode Control window controls the data acquisition for the CCDF Graph.

Capture – Select “On” to begin acquiring samples. “Off” stops the acquisition.

Reset – Clicking on Reset clears the acquired statistical sample population. If Capture is ON, a new acquisition will begin.

Term Action – Selects the action to take when either the *terminal count* is reached or the *terminal time* has elapsed. The available choices are Stop, Restart, or Decimate.

Stop - Stop accumulating samples and hold the result.

Restart - Clears the statistical sample population starts a new one.

Decimate - Divide all sample bins by 2 and continue. The total sample count will be halved each time decimation occurs. This should have very little visible effect on the CCDF values, since the entire population is decimated uniformly and the shape of the distribution is maintained.

Term Count – Sets the terminal sample count for the CCDF acquisition. The range of values is 0.1 to 1,000,000 megasamples.

Terminal Time – Terminal Time sets the terminal running time for the CCDF acquisition. The range of values is 1 to 3600 seconds.

Horiz Offset – Horiz(ontal) Offset sets the horizontal offset for the CCDF Graph statistical display. The value in dBr chosen will appear at the leftmost edge of the graph. The range of values is -50.00 dBr to +50.00 dBr.

Horiz Scale - Selects the horizontal scale for CCDF Graph statistical display. Scale factors are from 0.1 to 5 dB/div in a 1-2-5 progression.

Cursor Type - Select the independent variable for the CCDF cursor. If Percent is selected, relative power at the cursor's intersection with the CCDF curve will be measured. If Power is selected, probability at the cursor's intersection with the CCDF curve will be measured.

Cursor Pos – Sets the CCDF cursor to the desired probability or power depending on the setting of Cursor Type.

Gating – Selects Marker or Freerun gating for statistical acquisition. If Markers are selected, then only samples within the time marker interval on the Pulse Mode triggered sweep will be included in the statistical sample population. If Freerun is selected, then all the samples are acquired without regard to sweep acquisition.

Mark Ctrl – Clicking on this button will bring up the Marker Settings window allowing Marker locations to be set easily when marker gating is used for statistical capture.

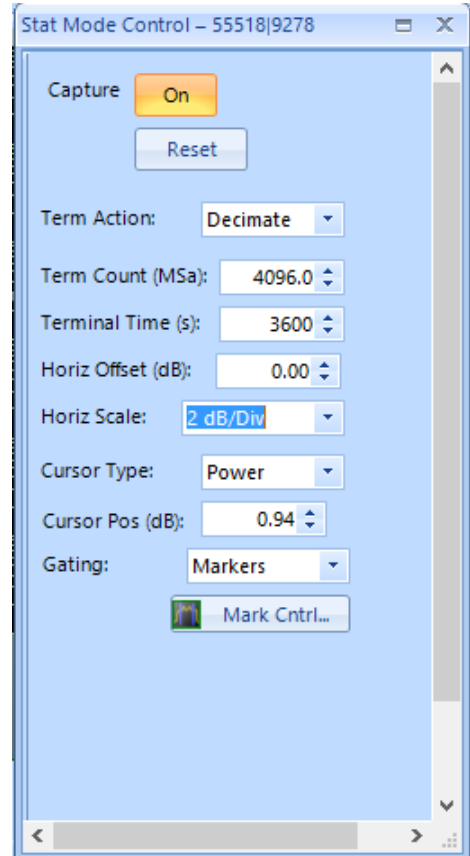

Figure 4.14 The Stat Mode Control window displaying key parameters of the CCDF Graph.

4.1.12 Statistical Measurements Display (RTP5000 only)

Clicking on the Stat Meas icon on the Measurement Control toolstrip brings up the Statistical Measurements window shown in Figure 4.15. This display of tabulated field parameters is displayed on the left side of the CCDF Graph by default.

These key statistical parameters are described in Table 4.3.

Parameter	Measurement Description
10% to 0.0001%	Displays crest factor relative to population average power at each specified %CCDF.
Pct at 0 dB	Displays %CCDF at the average power.
Cursor Pct	Displays %CCDF at the stat mode cursor.
Cursor Pwr	Displays crest factor relative to population average power at the Stat Mode cursor.
Average	Displays absolute average power of the statistical sample population.
Max	Displays absolute maximum power.
Min	Displays absolute minimum power.
Peak/Avg	Displays crest factor (pk/avg ratio).
Dynamic Rng	Displays dynamic range (max/min ratio).

Table 4.1

At the bottom of the Statistical Measurements window status is reported by four fields: Stat Capturing status (On or Off), Gating (Markers or Freerun), Total Time (HH:MM:SS), and number of Points (Megasamples) in the statistics. Additionally, there is an Export PDF button. Clicking on the Export PDF button will bring up a PDF Viewer popup window offering the ability to export the CCDF Graph in PDF format.

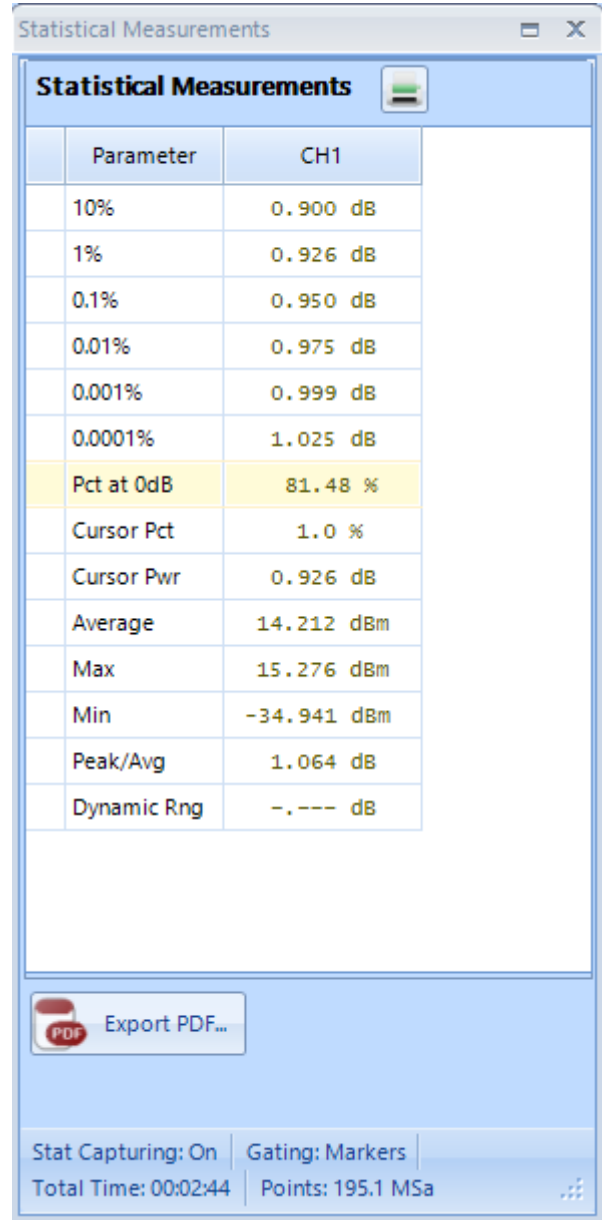

Figure 4.15 The statistical Measurements window displaying key parameters of the CCDF Graph.

4.1.13 Modulated Mode Measurements Display

Modulated measurement mode is designed for continuous, true average power measurements of complex modulated signals. The mode is similar to the operation of a conventional CW power meter, but does not suffer the measurement inaccuracies that occur when some diode sensors are used to measure modulated signals.

Modulated measurement mode is a continuous measurement mode primarily for continuously modulated or CW signals. Continuous (untriggered / free run) sample acquisition is performed using “sliding window” filtering on the samples. Filtered average power, peak power and minimum power measurements are continuously performed. The measured result is the average power of the signal. Since the graphic display would basically just show a straight line, measurements in this mode are best viewed using the Modulated Measurements display window. Figure 4.16 shows a Modulated Mode measurement displaying the average, minimum and maximum power in modulated signal.

Since this mode performs a continuous measurement, it does not differentiate when a pulsed or periodic signal is off, and when it is on. If you wish to make measurements that are synchronous with a period of a waveform, consider using a triggered sweep and marker analysis instead.

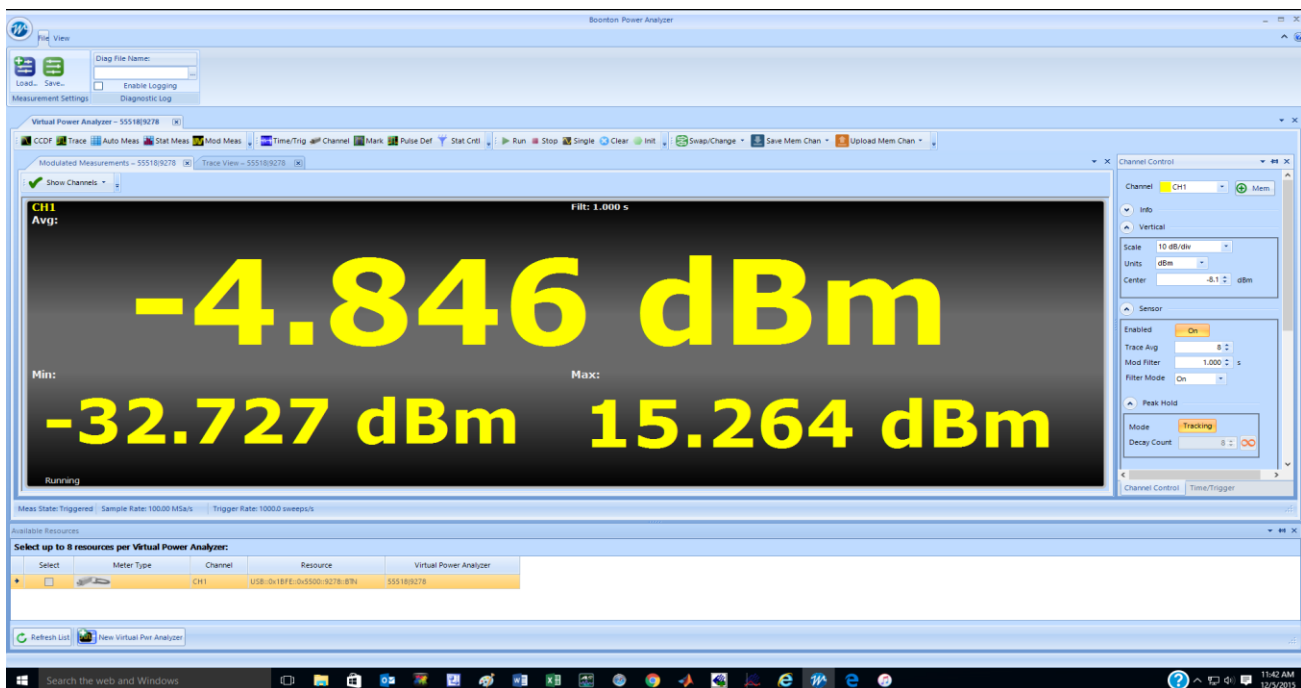

Figure 4.16 The Modulated Mode measurement display window showing the average, minimum, and maximum power of a modulated waveform for RTP5000 series sensors (average power only for RTP4000 models).



NOTE: The RTP5000 Real-Time Peak Power Sensors belong to the family of Peak Power sensors which respond to the amplitude modulation of a modulated carrier. Constant amplitude modulation schemes such as frequency and phase modulation (FM/PM) can be considered as a continuous wave (CW) carrier for power measurement purposes. Therefore, the Trace View display for a CW, PM/FM modulated (PSK, QPSK, etc) signal will appear as a flat line trace in the time domain.

Modulated Measurement is recommended for measuring the following signal types:

- Noise-like digitally modulated signals such as CDMA and OFDM when only average measurements are needed.
- When simple, non-synchronous measurements on a periodic or non-periodic signal are needed (overall average and peak power).

Modulated Measurement controls can be found on the **Channel Control** panel's **Sensor** section.

Modulation **Filter Mode** sets the current setting of the integration filter on the selected channel.

Off provides minimal filtering (1 ms integration window), and can be used at high signal levels when minimum settling time is required.

On allows a user-specified integration time as entered in the **Mod Filter** setting.

Auto uses a variable amount of filtering, which is set automatically by the power meter based on the current signal level to a value that gives a good compromise between measurement noise and settling time at most levels.

Mod Filter sets the current length of the modulation mode integration filter on the selected channel when Filter Mode is set to On. The integration time can be set from 2 milliseconds to 2.048 seconds in 1 ms increments.

4.1.14 Acquisition Status Bar

Figure 4.17 highlights the acquisition status bar in red. This bar, located beneath the graphical display, contains three status readouts: Meas State, Sample Rate and Trigger Rate.

The acquisition status bar provides useful information on the acquisition setup. The sampling rate and trigger rate are not reported in any other control window. Both are affected by the Timebase setting in the Time/Trigger Control window.

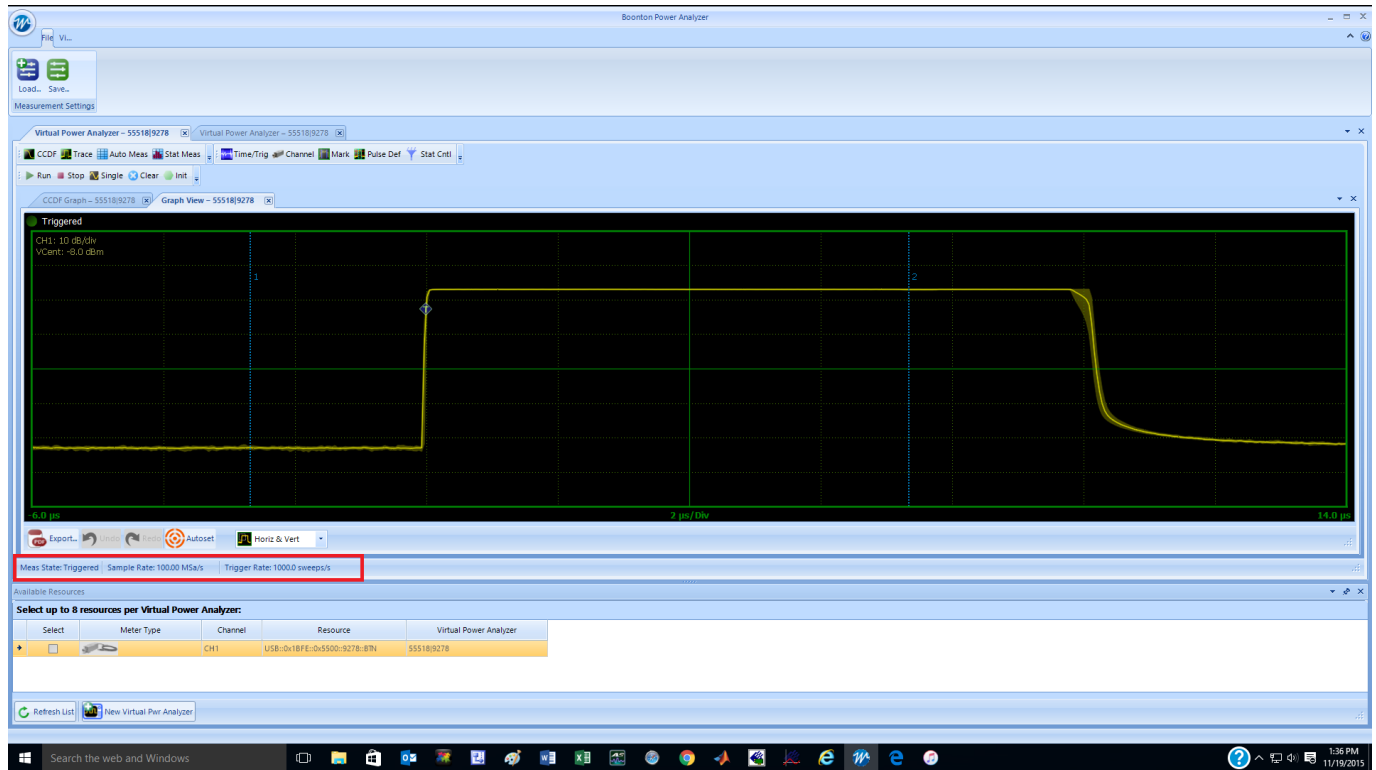

Figure 4.17 The acquisition status bar reports Meas State, Sample Rate, and Trigger Rate.

4.1.15 Archiving Measurement Setups

Measurement setups can be stored and recalled using the Save and Load buttons under the File tab as shown in Figure 4.18.

Once the **Power Analyzer Software** has been configured for a particular measurement, the application state can be saved by pressing the **Save** button. After pressing the Save button the user is prompted to enter a file name and path to save the measurement state. Measurement States are stored in Boonton .BMS file format.

Saved measurement states can be recalled using the Load button. When activated it prompts the user to choose the desired .BMS file. Upon selection the desired measurement state is restored.



Figure 4.18 Load and Save buttons for saving and recalling measurement setups

4.2 Multichannel Operation

The **Power Analyzer Software** supports simultaneous operation of up to eight RTP Series Real-Time Power Sensors. Figure 4.19 shows an example using two power sensors. The Trace View shows both power traces each in a distinct color which matches the annotation.

4.2.1 Multichannel Measurements

When multiple sensors are connected to the USB ports of the computer, make sure all sensors are displayed in the Available Resources. If certain sensors are not selectable, this means they are already assigned to a virtual power analyzer. All sensors in a virtual power analyzer will be displayed on the same Trace Window, if enabled.

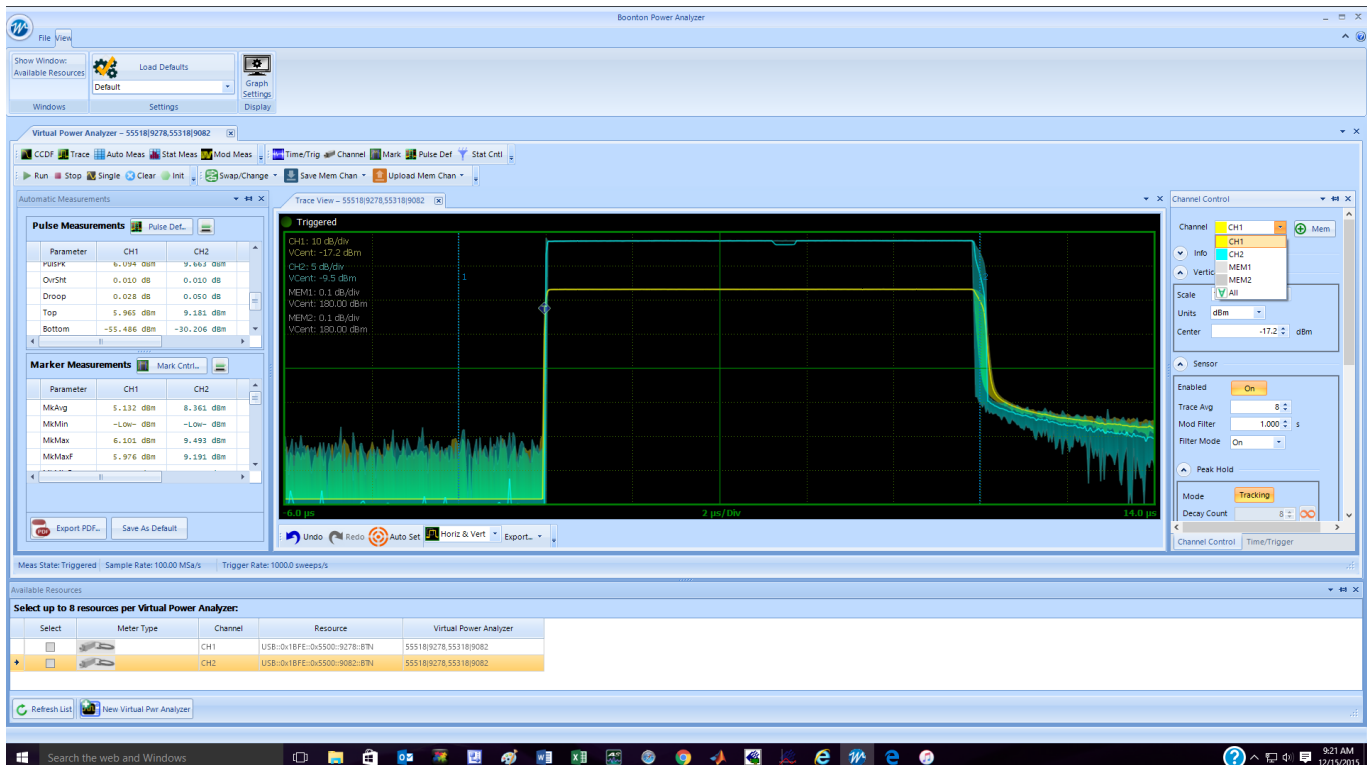

Figure 4.19 Up to eight RTP Series Real-Time Power Sensors can be supported by the **Power Analyzer Software**. In this example two sensors are connected.

The Channel Control selection list offers control of individual sources CH1, CH2, ...,CH8 as well as corresponding memory channels MEM1, MEM2, ..., MEM8 and ALL. If an individual measurement or memory channel is selected, then the channel control settings will only affect that channel. If ALL is selected, then the channel control settings affect all measurement simultaneously (memory channels are not grouped with some “ALL” settings). The timebase settings are common to all measurement channels displayed with the same Virtual Power Analyzer instance.

Multichannel Automatic Measurement

Clicking on the Auto Meas button on the measurement toolstrip will display the pulse measurement and marker measurement windows. Note, in Figure 4.19, that pulse and marker measurements now show measurements for each active sensor. Pulse definitions, like channel control, can be applied to each trace source individually or to all sources simultaneously. Marker location settings, being time locations, are common to all traces. Reference Lines are also associated, individually, with each displayed trace. Reference lines are color coded to match each trace.

Multichannel CCDF Graph View (RTP5000 only)

Statistical analysis behaves identically to the trace view. Both channel CCDF traces will be displayed on a common axis. Statistical measurements will have a measurement column for each sensor as shown in figure 4.20.

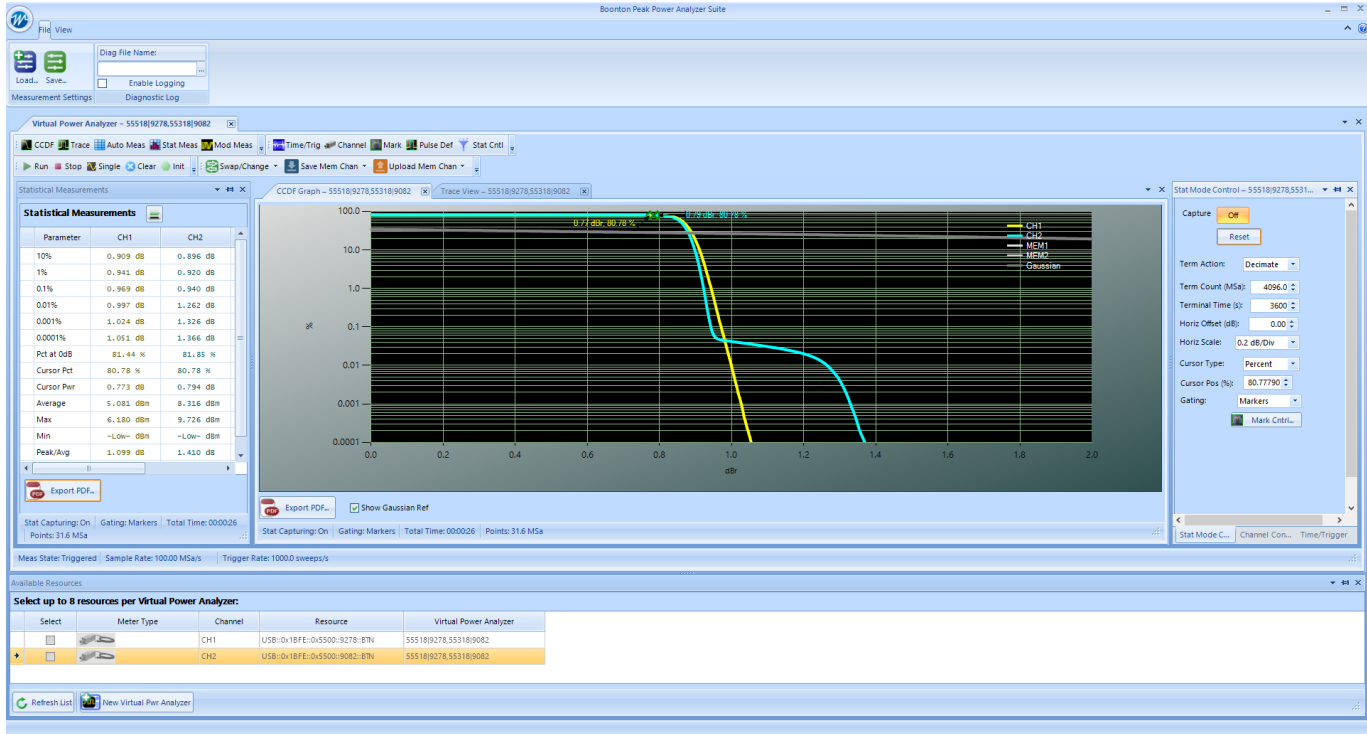

Figure 4.20 The CCDF Graph window in common multichannel operation. Multiple color-coded traces are displayed on a common grid.

Similar to the Trace View there is a color-coded trace for each sensor in the CCDF Graph View displayed on a common grid. Statistical Mode controls affect all traces in the common display.

Statistical Measurements are listed with a column for each sensor in the common multichannel tab.

4.2.2 Multichannel Triggering

When more than one sensor is present, there are different triggering options as shown in Figure 4.22.

Triggering Options

Unless they are intended to be triggered independently, power sensors should be connected to each other using the Multi-I/O connector as shown in Figure 4.21. To establish a communications path between the modules, a "trigger sync bus" is used to control both arming and triggering.

Multi-Channel Internal Triggering

When the Trigger Source for a multi-channel Virtual Power Analyzer is set to CH1, CH2, etc, one of the connected sensors is used as a common trigger for all channels. To facilitate this, the Multi-I/O connectors of all active sensors (channels) must be interconnected to create a "trigger distribution bus". The "master" sensor (selected trigger source) detects the trigger condition and distributes that event to other "slave" sensors to ensure synchronized triggering of all channels.

Figure 4.22 illustrates this connection. Note when three or more channels are present, a "tee adapter" will be required to interconnect all in parallel.

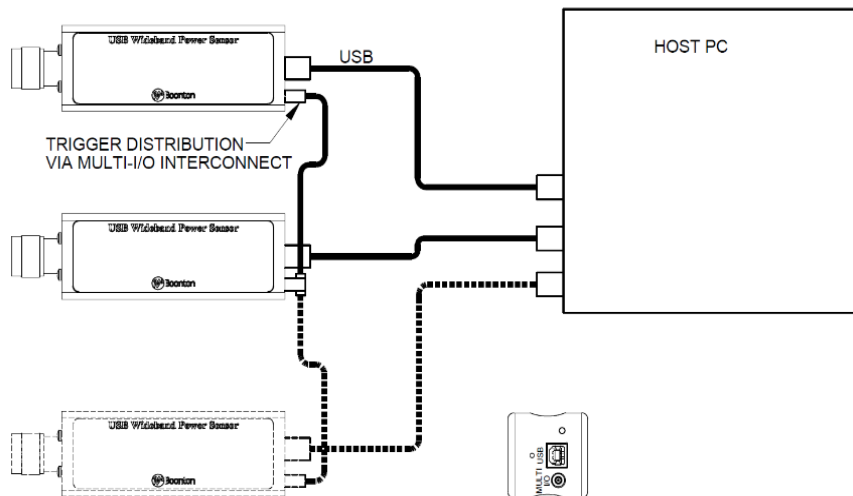

Figure 4.22 Coupling the Multi-I/O ports to establish a communication path between modules.

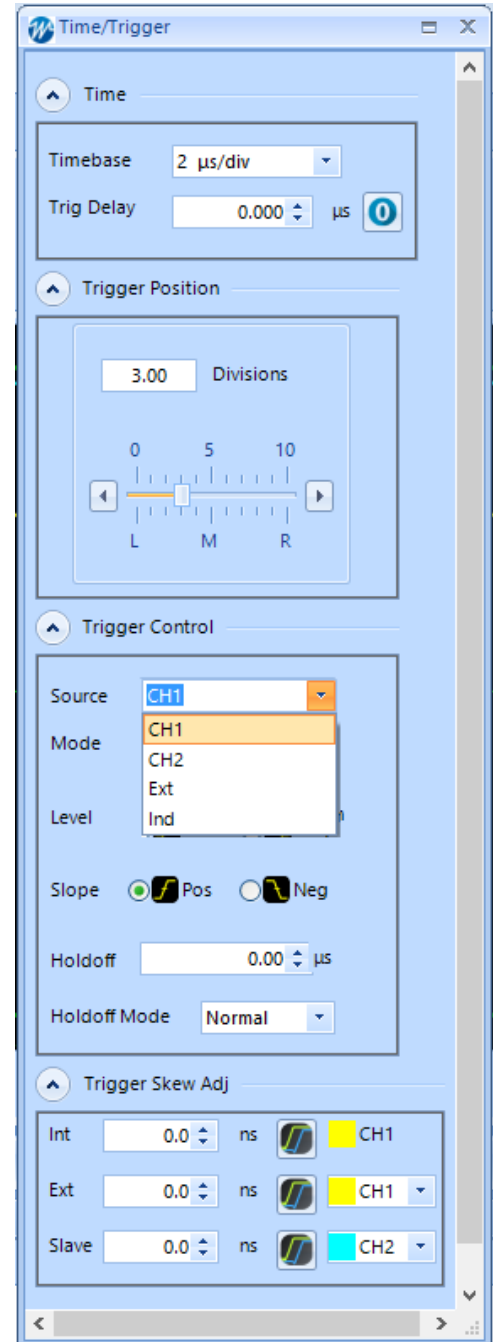

Figure 4.21 Trigger Source selection when two sensors are used.

Due to propagation delays in the master-to-slave trigger distribution, there is a small amount of timing skew between the master and slave channels. Sensors come pre-adjusted to minimize this skew, but it is possible to perform a fine trigger skew adjustment for performing critical channel-to-channel timing measurements. See the Trigger Skew Adjust paragraph in Section 4.1.5, Trigger Setup.

External Triggering

When the Trigger Source for a single or multi-channel Virtual Power Analyzer is set to EXT, a single user-supplied TTL signal is used as a common trigger for all channels. To facilitate this, the Multi-I/O connectors of all active sensors (channels) must be driven by the external trigger signal to ensure synchronized triggering of all channels.

Figure 4.23 illustrates this connection. When two or more channels are present, a "tee adapter" will be required to drive all Multi-I/O connectors in parallel.

Due to propagation delays in the external trigger system, there is a small amount of timing skew between the external trigger edge and RF signal for each channel. Sensors come pre-adjusted to minimize this skew, but it is possible to perform a fine trigger skew adjustment for performing critical channel-to-channel timing measurements. See the section on Trigger Skew adjustment in Section 4.1.5, Time/Trig Control Window.

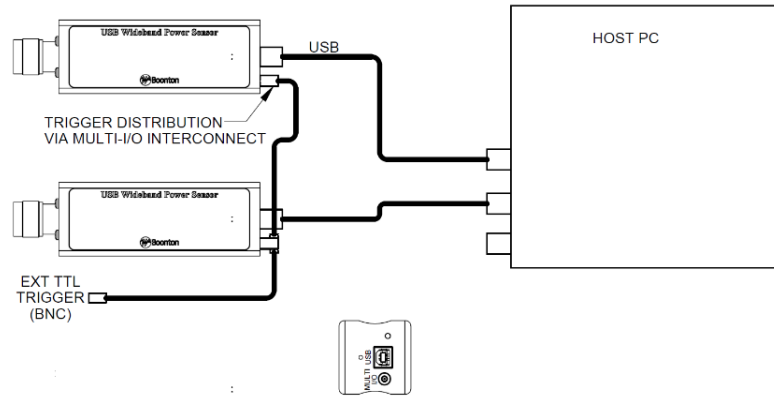

Figure 4.23 Multi I/O setup for using a common external trigger

Independent Triggering

Each sensor is internally triggered from its RF input signal. Select **Ind** from the drop-down menu of Source located in the Trigger Control panel of the Time/Trigger control window. Note that Ind source does not use the Multi-I/O connector.

4.2.3 Multichannel Individual Sensor Tabs

Multiple sensors can also be employed individually. Starting with multiple sensors listed in the Available Resources window, click on one sensor, then click the New Virtual Power Analyzer button. A Virtual Power Analyzer (VPA) tab will be opened listing the model and serial number of the selected sensor.

Click on another sensor in the Available Resources window and then click on the New Virtual Power Analyzer button again. A second VPA tab will be opened as shown in Figure 4.24. This mode of multichannel operation treats each sensor individually. Select a VPA tab and all the control windows apply only to the selected sensor. Each VPA Trace View will show the selected sensor as Channel 1 (CH1). They are differentiated by the model and serial number listed on the tab. Likewise, all measurement windows will list measurements only for the selected sensor.



Figure 4.24 Multi-channel sensors using individual Virtual Power Analyzer (VPA) tabs. Each sensor has its own control and measurement windows associated with it which are available when the sensor VPA tab is selected.

In this mode it is like having two different instances of the **Power Analyzer Software** and switching between them by selecting the appropriate VPA tab. There is no option to add a second sensor to an existing single-channel VPA. The only way to do that is to close the VPA channel and restart as a multichannel VPA.

4.3 Measurement Buffer Mode (API remote programming only)

Measurement Buffer Mode for the RTP Series Real-Time Power Sensors works in conjunction with **Real Time Power Processing™** to provide all relevant burst information including timing, power and crest factor while eliminating the need to buffer, download and post-process large sample buffers.

Measurement Buffer Mode captures and analyzes the input signal during time intervals of interest and discards information that occurs during non-relevant intervals. This mode of operation performs most analysis in real-time during capture. The big advantage this measurement buffer mode offers to the user is that it reduces the stream of sample data to a single data record for each pulse, burst or event. Even for the fastest pulse rates, the data rate to the user is orders of magnitude less than the sample data rate, so in most situations it becomes possible to store and transfer power analysis results to the user in real time with no gaps in acquisition or analysis.

The Measurement Buffer Mode circuitry can analyze and buffer points at better than 2M buffered points per second (depending upon operating mode). The RTP Series Real-Time Power Sensors internal measurement buffer can capture, analyze and store measurements for up to 2048 bursts at full rate. Additionally, a "circular" or FIFO capability allows continuous readout of buffered measurements by a host computer during capture and analysis. This real-time feature effectively removes the 2048 point internal buffer limitation, and permits capture and storage of test sequences of any size or duration to an external host measurement buffer. Continuous buffered capture is possible at sustained rates of better than 100K buffered points per second to a host memory array or disk file.

4.3.1 Overview

The RTP Series Real-Time Power Sensors measurement buffer consists of 2048 buffer entries, each containing information about a unique time interval.

Buffer Entries. Each "Buffer Entry" contains the following measurement values for that time interval:

- Average interval power
- Peak interval power
- Minimum interval power
- Interval start time (relative to start time of first entry)
- Interval duration (time from start to end of interval)
- Entry count (buffer reading number - increments each entry)

A 32-bit "Entry Count" counter (called "sequence number" in the IVI driver) keeps track of how many buffer entries have been processed and stored.

Table 4.3 shows a sample measurement buffer consisting of seven buffer entries. In this example, the buffer consists of seven entries, each corresponding to a single burst.

Entry Count	Interval Start	Interval Duration	Interval Average	Interval Minimum	Interval Peak
0	0.00 us	5.01 us	-0.043 dBm	-39.042 dBm	8.826 dBm
1	9.99 us	5.00 us	-0.006 dBm	-38.431 dBm	8.827 dBm
2	19.99 us	5.01 us	0.039 dBm	-41.549 dBm	9.742 dBm
3	30.00 us	5.00 us	0.017 dBm	-38.551 dBm	9.802 dBm
4	40.01 us	5.00 us	0.022 dBm	-40.699 dBm	9.477 dBm
5	49.99 us	5.00 us	-0.020 dBm	-39.706 dBm	8.102 dBm
6	60.00 us	5.00 us	0.036 dBm	-37.803 dBm	9.750 dBm

Table 4.2 Example of a Measurement Buffer Mode measurement containing seven entries

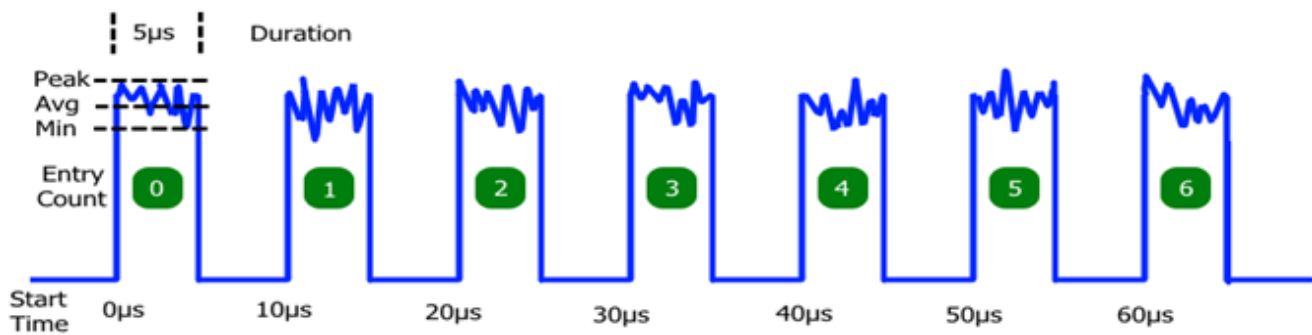

Figure 4.25 Sample burst signal showing buffer entry elements.

Buffer Gates. The measurement interval for each Buffer Entry is defined by a "gate" signal that controls the start and end of data acquisition for that entry. At the start of each gate interval, a fresh acquisition interval is initiated, and at the end of the gate, the acquisition interval is concluded and the result (the "buffer entry"), as shown in Figure 4.25, is written to memory. The gate signal may be internally or externally generated in several different ways - see "Gating Modes" section below.

Buffer Sessions. Each "Measurement Buffer Session" consists of a series of acquired buffer entries, stored in sequential order to an onboard memory. The duration of a session may be monitored and controlled by user command, by an external "run" signal, or limited to a preset number of entries or a preset time period. See "Session Arming" and "Session AutoStop" sections below. In the example above, the session consists of seven buffer entries, acquired over approximately 65 microseconds.

4.3.2 Measurement Buffer Mode Operation

Gating Modes. Each Buffer Entry is controlled by a "buffer gate" that defines the start and end of the entry time interval. The gate signal may be internally or externally generated in several different ways.

Marker Gate: Each buffer entry is "between markers" interval for one triggered sweep. This mode is used with the power sensor operating in triggered pulse mode, and the sweep system and markers are used to define the start and end of each gate interval. The entire gate interval must fall within the limits of the visible trace, so trigger and timebase settings must be appropriate for the signal.

Burst AutoGate: Each buffer entry consists of a single pulse or burst. The start and end of the burst are automatically identified by comparing the measured input signal to the trigger level threshold. Gate qualifying and delay options are available to align the gate interval with the desired portion of a burst.

External Gate: Each buffer entry consists of a single measurement interval gated by the logic state of the Multi-I/O input. Qualifying and delay options are available to align the gate interval with the Multi-I/O input.

External Trigger Gate: Each buffer entry is initiated by assertion of the Multi-I/O input and ends after a user-defined duration. Qualifying and delay options are available to align the gate start with the Multi-I/O input. If a qualified Multi-I/O assertion (rising edge) occurs prior to the programmed duration, the gate interval in progress will end immediately and a new interval will begin with no gap between intervals.

Periodic Gate: Buffer entries are self-timed intervals with user-defined period and duration. If period setting is less than or equal to duration setting, the period setting will be used for both and there will be no gap between successive intervals.

Acquisition of each entry begins upon assertion of the buffer gate, and concludes upon de-assertion of the buffer gate. When the gate interval starts, a fresh accumulation of power samples begins. When the entry interval ends, the accumulated power samples are processed to yield one set of avg/min/max and duration values for the entire interval, and this result is stored to the next available buffer location in memory.

Power samples are not accumulated when the gate is inactive. Buffer entries (gates) may not overlap, however gap-less buffering (zero "gate inactive" time) is possible in certain modes. In this case, a new gate interval begins immediately upon completion of the preceding gate interval.

Gate Qualify. If the Gate Mode is set for Burst AutoGate or External Gate/Trigger, additional criteria and time delays may be imposed to aid in aligning the gated measurement on a desired signal interval. Start and End qualifying values indicate the time that the controlling input (RF signal level or MIO external gate) must remain above or below the qualifying threshold (trigger level for RF input, TTL levels for MIO) to be recognized.

The Start qualifier can be used to reduce sensitivity to brief noise spikes while the burst is "off". Typically, the start qualify time will be short - perhaps 10 to 50 ns.

The End qualifier is commonly used to avoid premature burst end detection when burst modulation causes the RF signal to briefly fall below the qualifying threshold. For wideband modulation, this value must be longer than expected modulation dips, but shorter than intra-burst gaps - typically 50 to 200 ns.

The internal gate signal is automatically adjusted to align with the beginning of recognized qualifying intervals - no user adjustment is necessary. This means that the qualified gate which controls buffering will correspond to the actual start and end of the burst, and not be delayed by the qualifying times.

Gate Start/End Delay. If time adjustment of the qualified gate interval is needed to align the desired gate interval with signal timing, the start and end times may be delayed by a user-controlled value. Gate delays may be positive or negative to permit moving the gate interval ahead or back in time, respectively.

A positive start delay can be used to exclude the rising edge of a burst, or to exclude a training sequence of known duration. Similarly, a negative end delay will cause the qualified gate to end early, so can be used to exclude the falling edge of a burst.

Since all processing is done in real-time, a built-in signal FIFO is used to permit the "look-back" action necessary to start or end a gate interval prior to the qualifying event. Therefore, the difference of the qualifying time and gate delay for both the start and end gates cannot exceed the FIFO depth of 20 microseconds (implementation specific). This means that if the end qualify time is 2 us, the end delay may be no more negative than -18 us. To simplify settings control, the available time is split in half between the gate qualify and negative delay limits.

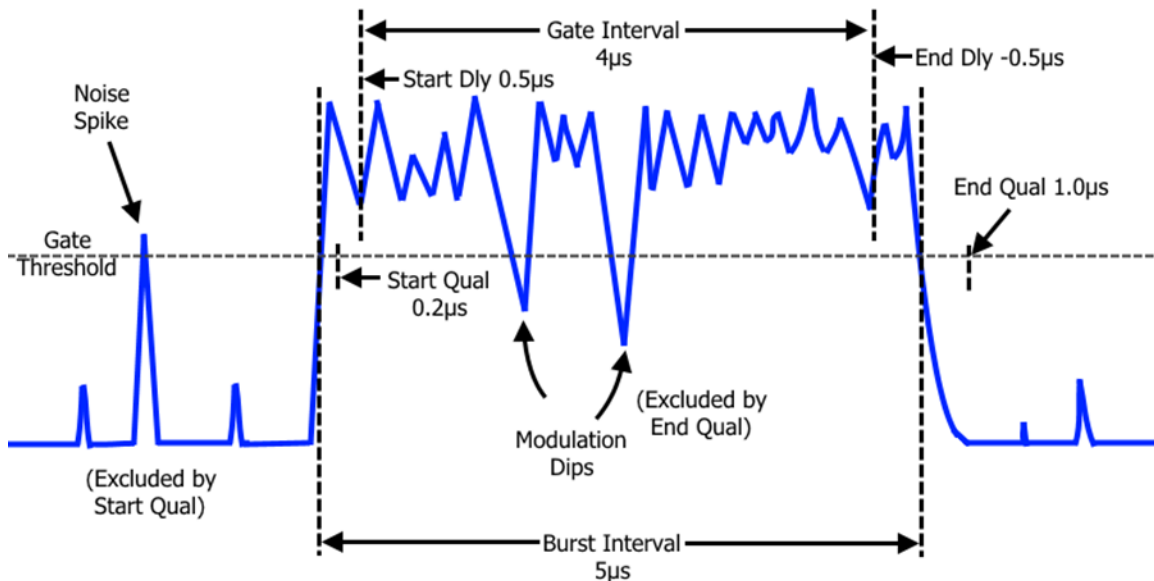

Figure 4.26 Gate Qualify and Delay

Figure 4.26 illustrates how gate qualify and delay options may be combined to align the desired buffer gate with a signal burst.

- The **StartQualify** time is set to 0.2 us so the start of the burst will only be recognized when the signal remains above the gate threshold for 0.2 us or longer. This ensures that brief noise spikes while the burst is off are not recognized as a valid burst.
- The **EndQualify** time is set to 1.0 us so the end of the burst will only be recognized when the signal remains below the gate threshold for 1.0 us or longer. This ensures that brief modulation dips during the burst do not prematurely end the gate interval.
- The **StartDelay** time is set to 0.5 us. This begins the gate interval 0.5 us after the beginning of the StartQualify interval and is used to exclude rising edge effects such as transition time or overshoot from the gate measurement.
- The **EndDelay** time is set to -0.5 us. This ends the gate interval 0.5 us before the beginning of the EndQualify interval and is used to exclude falling edge effects such as transition time from the gate measurement.

The entire qualified "burst interval" is 5 us long - starting and ending at the beginning of the StartQualify and EndQualify times. The final "gate interval" is offset at the start and end of the burst to exclude rising and falling edge effects. *Therefore, the measured "duration" stored in the buffer for the 5 us burst shown will be about 4 us.*

Session Arming (Start) control. Although buffered acquisition may be enabled ("running"), no data is collected unless the session is "armed" to accept gate signals (see "Gating Modes"). Recognition of the selected gate signal is controlled by arming or disarming the session.

When a session is armed, one buffer entry will be written to the buffer memory at the conclusion of each gate interval. When the session is not armed, gate signals are ignored, and no entries are saved. This permits a session to be launched or controlled via user software or an external signal.

The following settings are available to arm or control Measurement Buffer sessions.

- Immediate:** The session is armed immediately - each valid gate signal will generate a buffer entry. The session remains armed until disarmed by other means (see "Session Stop" below).
- ExtStart:** The session is armed upon assertion of an external start (arming) pulse on the Multi-I/O. Following arming, the buffer system will remain armed, and each valid gate signal will generate a buffer entry. The session remains armed until disarmed by other means (see "Session Stop" below).
- ExtEnable:** The session is armed when the external enable signal to the Multi-I/O is asserted, and will remain armed as long as the Multi-I/O is asserted. If the Multi-I/O is de-asserted, the system disarms and sample acquisition halts. Asserting the Multi-I/O signal again re-arms and continues collecting buffer entries from the previous location - it does not reset the buffer.

At the start of any Measurement Buffer session, the buffer status is reset. This clears the entry count and discards any unread entries.

Session Auto-Stop conditions. Each Buffer Session may be automatically terminated - this disarms the session so no further entries are stored. Entries which have already been started are aborted without being written. Automatic stop can occur in several ways:

- Counted:** The current Measurement Buffer session is terminated when "N" buffer entries have been acquired during that session.
- Timed:** The current Measurement Buffer session is terminated "T" seconds after the start of the session.
- ExtEnable:** The current Measurement Buffer session is terminated upon de-assertion of an external buffer enable signal on the Multi-I/O.
- Overflow:** The current Measurement Buffer session is terminated if the number of unread entries reaches the capacity of the buffer.



NOTE: Auto-stop criteria are all examined, therefore the session will terminate for whichever event occurs first. Users may opt to configure or disable any or all of the auto-stop criteria.

Mbuf Enable Modes. Overall control of the Measurement Buffer system is handled in much the same way as other measurements - user controls for "Run", "Stop" and "Reset" are available.

MbufEnable=ON: Reset the Measurement Buffer system and enable a new Measurement Buffer session. Acquisition will begin with the first buffer entry once the system is armed (see "Session Arming (Start) control") and a valid gate signal is received (see "Gating Modes").

MbufEnable=OFF: Halts any Measurement Buffer session in progress. If the gate is currently active, its acquisition data will be lost. This functions as a "stop" command and all acquired buffer data will still be available to read. Note that sessions may already be stopped due to "auto-stop" conditions being met

MbufReset Halts and clears the Measurement Buffer system. This will force MbufEnable to OFF. The read count and write index are returned to zero and no buffer data will be available to read.

Buffer Read. Users may read the entire buffer contents once the session is complete, or may read any newly acquired entries while the buffer session is in progress. User settings control the maximum number of entries to be returned for each I/O read, up to the full capacity of the buffer. However, the number of returned entries will be limited to the number of "new" (acquired, unread) buffer entries.

Each time the user reads entries from the buffer, a read pointer is incremented by the number of entries returned, and subsequent user reads will return new buffer elements beginning with the first unread entry.

Circular/Continuous Buffer Acquisition. If the number of entries in a buffer session reaches the end of the measurement buffer without stopping, buffered acquisition will continue in circular fashion - that is entries will "wrap" and begin refilling the buffer from the start.

Ordinarily, this would overwrite the buffer contents, resulting in loss of acquired measurements. However, since users can read buffer sessions during acquisition, it is possible to periodically empty the buffer so overwrite of old data does not occur.

From a user perspective, the buffer appears as a 2048 element FIFO. Provided the user avoids FIFO overflow by reading the buffer periodically, the buffer entries may be stored externally by the user to create buffers of any size desired.

If the user is not able to read the buffer before overflow occurs, two options are available to control behavior:

Overflow Protection ON: Enables auto-stop for pending buffer overflow. Buffer entries continue to be acquired in circular fashion provided the user periodically reads the buffer. But if the buffer fills to capacity (2048 unread entries) without being emptied, the session is terminated and no further entries are stored. This mode gives priority to the earliest acquired entries and ignores events after the session terminates. **DEFAULT MODE.**

Overflow Protection OFF: Disables auto-stop for buffer overflow. Buffer entries continue to be acquired in circular fashion without regard to read status by the user. If the buffer fills to capacity (2048 unread entries) without being emptied, new entries will continue to be stored, and will overwrite the oldest entries. This mode gives priority to the latest acquired entries, and discards older events whether or not they have been read by the user.

4.3.3 Measurement Buffer Mode User Settings

The following settings, queries and controls are exposed to the user with the applicable modes and argument options or numeric ranges shown. Note that this is the SENSOR command interface, and may not align exactly with the API interface. Please consult API documentation for available settings and queries.

Gate Settings

MbufGateMode	[MarkerGate BurstAutoGate ExtGate ExtTrigGate PeriodicGate]
MbufGateStartQual	0.0 to 10 us (BurstAutoGate, ExtGate and ExtTrigGate)
MbufGateStartDelay	-10 us to 100 ms (BurstAutoGate, ExtGate and ExtTrigGate)
MbufGateEndQual	0.0 to 10 us (BurstAutoGate and ExtGate)
MbufGateEndDelay	10 us to 100 ms (BurstAutoGate and ExtGate)
MbufGatePeriod	100 ns to 10 s PeriodicGate)
MbufGateDuration	100 ns to 100 ms (ExtTrigGate and PeriodicGate)

Session Control Settings

MbufStartMode	[Immediate ExtStart ExtEnable]
MbufStopCount	1 to 1M rdgs (<=0 disables counted auto-stop)
MbufStopTime	1 ms to 1000 s (<=0 disables timed auto-stop)
MbufProtection	[on off] Enables auto-stop for buffer overwrite
MbufEnable	[on off] "run/stop" control
MbufReset	Stops and resets the measurement buffer session

Measbuf Readback Settings

MbufFetchCount	1 to 2048	Sets # of entries to be returned to user
MbufAvailCount?		Returns # of unread entries in MBUF
MbufFetchNext?		Returns next "MbufFetchCount " entries, incr ptr
MbufFetchIndex[?]		Sets or returns current read pointer index

Multi-I/O Priority. The RTP Series Real-Time Power Sensors Multi-I/O connector may be used as input or output in several different ways. When conflicts occur, priority must be determined or undefined behavior will result.

Multi-Channel Operation: When synchronized buffering between multiple channels is required, the concept of "master" and "slave" will again be needed to ensure gate intervals align between sensors. The "Trigger Source" logic can be used here.

In all configurations requiring a separate master and slave, the supplied "TriggerSync" cable must be used to interconnect the Multi-I/O connectors of the master and all slaves. Where more than one slave is present, additional cables and a "T" adapter will be needed for the parallel connection.

The Multi-I/O connector is not required by the Measurement Buffer system in many Single-channel configurations

Mode	Master	Slave	Required Connections
Marker Gate	Pulse mode trigger out/arm status in signal to/from the Multi-I/O connector. Mbuf gate signal is internally generated by sweep system in each sensor.	Pulse mode trigger in/arm status out signal to/from Multi-I/O. Mbuf gate signal internally generated by sweep system using same marker settings as master, so will be synchronized.	Interconnect Multi-I/O inputs of master and all slaves.
Burst AutoGate	RF Burst is qualified/delayed by master to create the Mbuf gate. Master Multi-I/O outputs the Mbuf gate to all slaves.	Multi-I/O receives qualified/delayed burst-detect signal from master. Each slave operates in "Ext Gate" Mbuf mode, so will follow master.	Interconnect Multi-I/O inputs of master and all slaves.
External Gate	There is no "master" or "slave" for this mode. All Multi-I/O inputs receive the ExtGate signal from a user source to gate each Mbuf entry. Mbuf entries for all connected sensors start and end in sync upon assertion and de-assertion of user ExtGate signal.		Drive Multi-I/O inputs of all sensors from user-supplied External Gate logic signal.
External TrigGate	There is no "master" or "slave" for this mode. All Multi-I/O inputs receive the ExtTrigGate signal from a user source to initiate each Mbuf entry. Mbuf entries for all connected sensors start in sync upon assertion of user ExtTrigGate signal and end after user-configured time duration.		Drive Multi-I/O inputs of all sensors from user-supplied External Gate logic signal.
Periodic Gate	Master uses internal period and duration timers to control start and end of each Mbuf entry. Multi-I/O of master outputs 100 ns "start pulse" at the start of each Mbuf period.	Slaves operate in External Trigger Mbuf mode. All slave Multi-I/O inputs receive the start pulse from master to initiate each Mbuf entry. Each slave times the duration to end each entry.	Interconnect Multi-I/O inputs of master and all slaves.

Table 4.3 Summary of the Measurement Buffer functions and I/O connections in a multi-channel environment

Driver for RTP Sensors Functionality. The API for RTP Sensors exposes all of the measurement buffer controls and functions described in this section. However, for most use cases, the API offers a simplified set of methods and properties to allow the user to specify an arbitrary number of measurements to capture. This allows the programmer to specify the pertinent modes and gate qualifications, acquire a user-specified number of measurements, and then retrieve the buffered measurement arrays.

For further information see the [RTP Series Power Sensor Programming Reference](#).

5. Remote Programming

5.1 Introduction

The RTP Series Real-Time Power Sensors may be remote controlled by end users using an Application Programming Interface (API). The API for RTP Sensors can be used by many programming environments and languages including C/C++, Python, Visual Basic, Visual C#, LabVIEW, MATLAB, and others. This API permits user applications to access power sensor control and measurement functions via a Dynamic Link Library (DLL). For more information, please see the [RTP Series Power Sensor Programming Reference](#).

5.2 Examples

Boonton provides programming examples using C++, C#, and Visual Basic. These can be downloaded on the “Manuals & Software” page on the Boonton website.

An online command reference for the RTP Series API is available on the Boonton website.

5.3 Communication overview

User software interfaces with the sensor via an Application Programming Interface (API). Settings and measurements can be set and queried using functions and properties defined in the programming reference. The API communicates with the sensor using low level calls to Microsoft's Windows USB driver (WinUSB). WinUSB then sends and receives proprietary binary commands and responses from the sensor. Figure 5.1 shows a graphical representation of the data flow between a user application and a RTP Series Real-Time Power Sensors.

RTP Series Real-Time Power Sensors Communication Data Flow

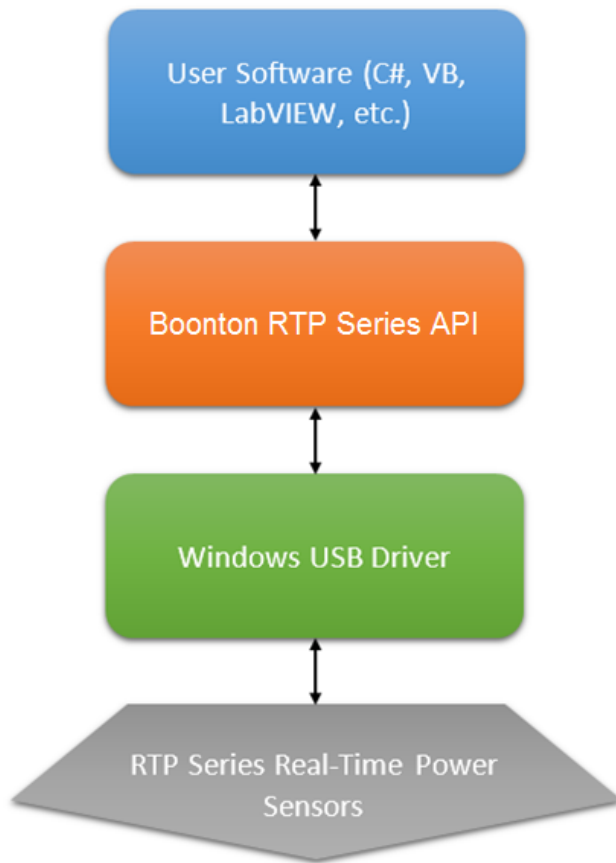

Figure 5.1 A graphical representation of the communications data flow

6. Making Measurements

6.1 Pulse Measurements

6.1.1 Pulse Definitions

IEEE Std 181™-2011 IEEE Standard for Transitions, Pulses, and Related Waveforms, provides fundamental definitions for general use in time domain pulse technology. Several key terms defined in the standard are reproduced in this subsection, which also defines the terms appearing in the RTP Series Real-Time Power Sensors text mode display of automatic measurement results.

6.1.2 Standard IEEE Pulse

The key terms defined by the IEEE standard are abstracted and summarized below. These terms are referenced to the standard pulse illustrated in Figure 6.1.

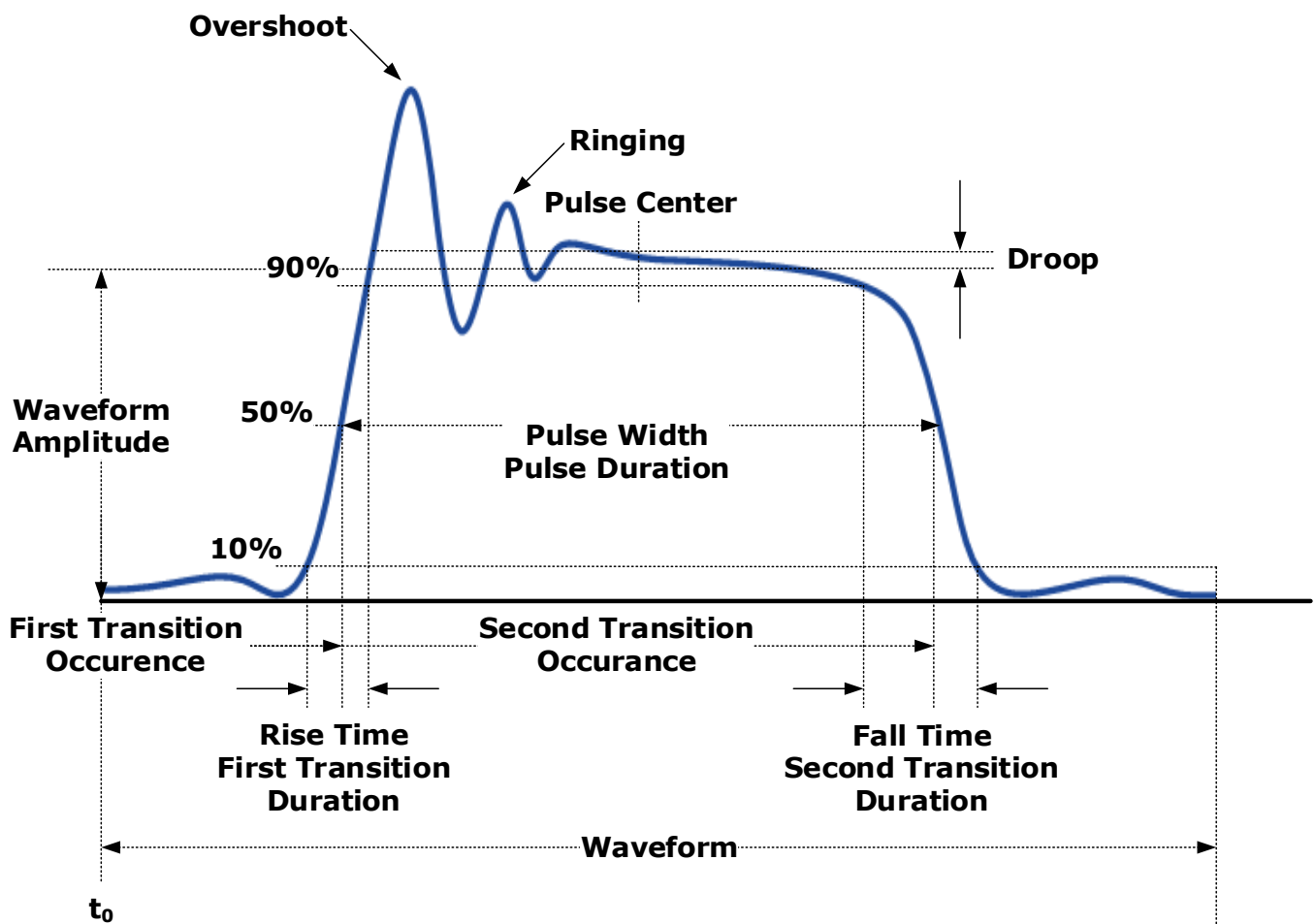

Figure 6.1 IEEE Standard Pulse (IEEE Std 181™-2011)



NOTE: IEEE Std 194™-1977 IEEE Standard for Pulse Terms and Definitions has been superseded by IEEE Std 181™-2003 and -2011. Many of the terms used below have been deprecated by the IEEE. However, these terms are widely used in the industry and familiar to users of Boonton power meters. For this reason, they are retained.

TERM	DEFINITION
Base Line	The two portions of a pulse waveform which represent the first nominal state from which a pulse departs and to which it ultimately returns.
Top Line	The portion of a pulse waveform which represents the second nominal state of a pulse.
First Transition	The major transition of a pulse waveform between the base line and the top line (commonly called the rising edge).
Last Transition	The major transition of a pulse waveform between the top of the pulse and the base line. (Commonly called the falling edge.)
Proximal Line	A magnitude reference line located near the base of a pulse at a specified percentage (normally 10%) of pulse magnitude.
Distal Line	A magnitude reference line located near the top of a pulse at a specified percentage (normally 90%) of pulse magnitude.
Mesial Line	A magnitude reference line located in the middle of a pulse at a specified percentage (normally 50%) of pulse magnitude

Table 6.1 Pulse Measurement Amplitude Threshold Terms

6.1.3 Automatic Pulse Measurements

The RTP Series Real-Time Power Sensors and the **Power Analyzer Software** or API automatically analyzes the waveform data in the buffers and calculates key waveform parameters. The calculated values are displayed in Auto Meas window.

Table 6.2 summarizes the automatic field parameters available. Note that the Pulse Measurements can be edited and customized. Amplitude related parameters will be displayed in the same units as selected in the Channel Control Window.

Field Label	Parameter	Definition
Width	Pulse Width	The interval between the first and second signal crossings of the mesial line.
Rise	Risetime	The rising edge time interval from the first crossing of the proximal line to the first crossing of the distal line.
Fall	Falltime	The falling edge time interval from the last crossing of the distal line to the last crossing of the proximal line.
Period	Pulse Period	The time interval between two successive rising edges or two successive falling edges. (Reciprocal of the Pulse Repetition Frequency)
PRF	Pulse Repetition Frequency	The number of cycles of a repetitive signal that take place in one second.
Duty	Duty Cycle	The ratio of the pulse on-time to off-time.

Offtime	Off-time	The time a repetitive pulse is off. (Equal to the pulse period minus the pulse width).
WavAv	Waveform Average Power	Waveform Average Power
PulsAv	Pulse Average On Power	The average “on” power level across the pulse width, defined by the intersection of the pulse rising and falling edges with the mesial line, and offset by the StartGate and EndGate settings.
PulsPk	Pulse Peak Power	The maximum power level of the captured waveform
OvrSht	Overshoot	Leading edge overshoot (The difference between the maximum amplitude of the overshoot and the top line).
Droop	Pulse Droop	Rise or Droop in amplitude between the start and end of the pulse, as defined by the StartGate and EndGate settings.
Top	IEEE Pulse Top Amplitude	The amplitude of the top line. (See IEEE definitions)
Bot	IEEE Pulse Bottom Amplitude	The amplitude of the base line. (See IEEE definitions)
EdgDly	Edge Delay	The delay time relative to the trigger of the first onscreen mesial level transition of either polarity. The Edge Delay value will be negative if the mesial transition occurs before the trigger event, and positive if it occurs after the trigger event.
Skew	Channel-to-Channel Skew	The time between the mesial level of a pulse on Channel 1 and a pulse on Channel 2. The pulse can be the power or trigger signal.

Table 6.2 Automatic Measurement Parameters

6.1.4 Automatic Pulse Measurement Criteria

Automatic measurements are made on repetitive signals that meet the following conditions:

Amplitude. The difference between the top and bottom signal amplitudes must exceed 6 dB to calculate waveform timing parameters (pulse width, period, duty cycle). The top-to-bottom amplitude difference must exceed 13 dB to measure rise and falltime.

Timing. In order to measure pulse repetition frequency and duty cycle, there must be at least three signal transitions. The interval between the first and third transition must be at least 1/5 of a division (1/50 of the screen width). For best accuracy on rise and falltime measurements, the timebase should be set so the transition interval is at least one-half division on the display.

6.1.5 Automatic Pulse Measurement Sequence

The automatic measurement process analyzes the captured signal data in the following sequence:

1. Approximately 500 samples of the waveform (equivalent to one screen width) are scanned to determine the maximum and minimum sample amplitudes.
2. The difference between the maximum and minimum sample values is calculated and stored as the Signal Amplitude.
3. The Transition Threshold is computed as one-half the sum of the maximum and minimum sample amplitudes.

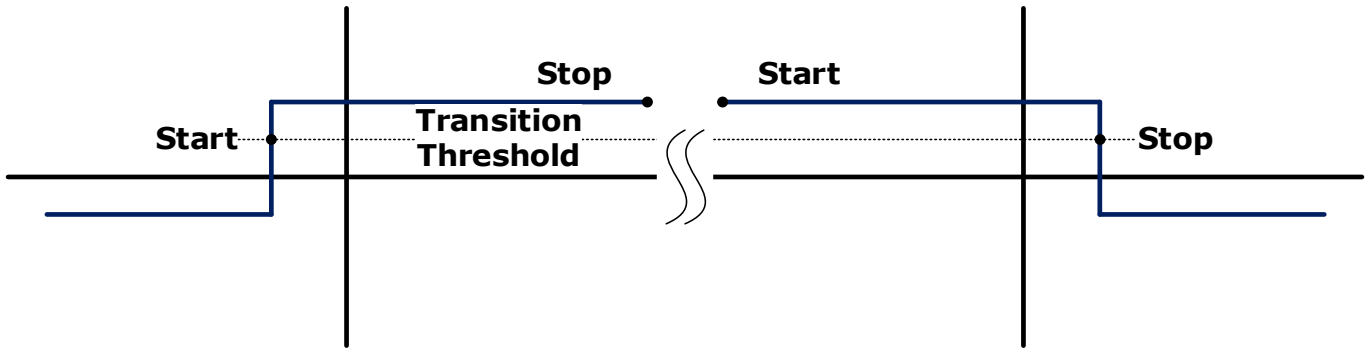

Figure 6.2 Step Waveforms

4. The processor locates each crossing of the Transition Threshold.
5. Starting at the left edge of the screen, the processor classifies each Transition threshold crossing according to whether it is positive-going (– +) or negative-going (+ –). Because the signal is repetitive, only three transitions are needed to classify the waveform, as shown in Table 6.3:

Type	Edge Sequence	Description
0	none	No crossings detected
1	Not used	
2	+ –	One falling edge
3	– +	One rising edge
4	+ – +	One falling, followed by one rising edge
5	– + –	One rising, followed by one falling edge
6	+ – + –	Two falling edges
7	– + – +	Two rising edges

Table 6.3 Waveform Classification Types

6. If the signal is Type 0, (No crossings detected) no measurements can be performed and the routine is terminated, pending the next reload of the measurement buffers.

7. The process locates the bottom amplitude (baseline) using the IEEE histogram method. A histogram is generated for all samples in the lowest 12.8 dB range of sample values. The range is subdivided into 64 power levels of 0.2 dB each. The histogram is scanned to locate the power level with the maximum number of crossings. This level is designated the baseline amplitude. If two or more power histograms contain equal counts, the lower is selected.

8. The process follows a similar procedure to locate the top amplitude (top line). The power range for the top histogram is 5 dB and the resolution is 0.02 dB, resulting in 250 levels. The level-crossing histogram is computed for a single pulse, using the samples which exceed the transition threshold. If only one transition exists in the buffer (Types 2 and 3), the process uses the samples that lie between the edge of the screen and the transition threshold as shown in Figure 6.2.

9. The process establishes the proximal, mesial, and distal levels as a percentage of the difference between top amplitude and bottom amplitude power. The percentage can be calculated on a power or voltage basis. The proximal, mesial, and distal threshold values are user settable from 1% to 99%, with the restriction that the proximal < mesial < distal. Normally, these values will be set to 10%, 50% and 90%, respectively.

10. The process determines horizontal position, in pixels, at which the signal crosses the mesial value. This is done to a resolution of 0.1 pixel, or 1/5000 of the screen width. Ordinarily, the sample values do not fall precisely on the mesial line, and it is necessary to interpolate between the two nearest samples to determine where the mesial crossing occurred. This process is illustrated in the example shown in Figure 6.3.

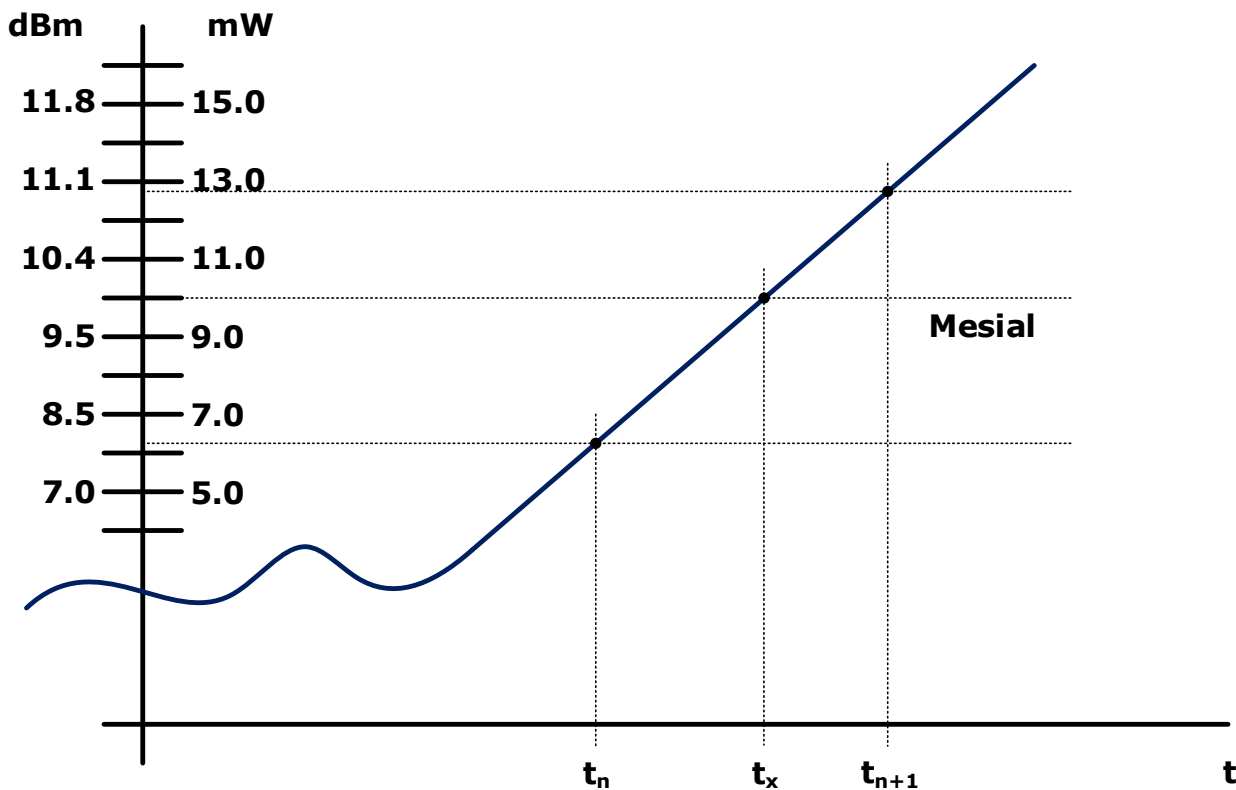

Figure 6.3 Time Interpolation example

Item	dBm	mW
Mesial value	10.0	10.0
Sample n	8.0	6.3
Sample n+1	11.0	12.6

The interpolated crossing time, t_x , is calculated as follows:

$$t_x = t_n + \frac{P_{mes} - P_n}{P_{n+1} - P_n}$$

where P is in watts and n is the number of the sampling interval, referenced to the trigger event.

For this example:

$$\begin{aligned} t_x &= t_n + \frac{10.0 - 6.3}{12.6 - 6.3} \\ &= t_n + 0.6 \end{aligned}$$

11. The processor computes the rise and/or falltimes of waveforms that meet the following conditions:

- a) The waveform must have at least one usable edge (Types 2 through 7, as shown in Table 6.3)
- b) The signal peak must be at least 13 dB greater than the minimum sample value.

The risetime is defined as the time between the proximal and distal crossings (– +).

The falltime is defined as the time between the distal and proximal crossings (+ –).

If no samples lie between the proximal and distal values for either edge (rise or fall), the risetime for that edge is set to 0 seconds.

12. The processor calculates the output values if applicable according to the following definitions:

- a) Pulse Width Interval between rising and falling edge mesial points
- b) Risetime See Step 11
- c) Falltime See Step 11
- d) Period Cycle time between successive mesial points of the same polarity
- e) Pulse Repetition Frequency Reciprocal of Period
- f) Duty Cycle Pulse Width/Period
- g) Off-time (Period) - (Pulse Width)
- h) Peak Power Maximum sample value between StartGate time and EndGate time (See Step 1)
- i) Pulse Power Average power between StartGate time and EndGate time
- j) Overshoot (Peak Power) - (Top Amplitude)
- k) Average Power See Step 13
- l) Top Amplitude See Step 8
- m) Bottom Amplitude See Step 7
- n) Droop between StartGate time and EndGate time
- o) Skew See Step 14

6.2 Marker Measurements

Table 6.4 summarizes the Marker Measurements available. Note that the Marker Measurements can be edited and customized. Amplitude related measurements will be displayed in the same units as selected in the Channel Control window.

Field Label	Parameter	Definition
MkAvg	Marker Average	Average power over marker interval
MkMin	Marker Minimum	Minimum instantaneous power over marker interval
MkMax	Marker Maximum	Maximum instantaneous power over marker interval
MkMaxF	Marker Maximum Filtered	Maximum average (filtered) power over marker interval
MkMinF	Marker Minimum Filtered	Minimum average (filtered) power over marker interval
MkPk2A	Marker Peak to Average	Peak-to-Average power ratio over marker interval
Mk1Lvl	Marker 1 Level	Average power at marker 1
Mk2Lvl	Marker 2 Level	Average power at marker 2
MkMaxAv	Marker Max Interval Average	Highest value of average-between-markers
MkMinAv	Marker Min Interval Average	Lowest value of average-between-markers
Mk1Min	Marker 1 Minimum	Minimum power or voltage at the Marker 1
Mk1Max	Marker 1 Maximum	Maximum power or voltage at the Marker 1
Mk2Min	Marker 2 Minimum	Minimum power or voltage at the Marker 2
Mk2Max	Marker 2 Maximum	Maximum power or voltage at the Marker 2
MkRatio	Marker Ratio	Ratio of Marker 1 to Marker 2
MkDelta	Marker Amplitude Difference	Amplitude difference between Marker 1 and Marker 2
MkRDelta	Marker Reverse Difference	Amplitude difference between Marker 2 and Marker 1
MkRRatio	Marker Reverse Ratio	Ratio of Marker 2 to Marker 1
Mk1Time	Marker 1 Time	Time at Marker 1
Mk2Time	Marker 2 Time	Time at Marker 2
MkTimeDelt	Marker Time Difference	Time Difference between Marker 1 and Marker 2

Table 6.4 Marker Measurements

6.2.1 Average Power Over a Time Interval

13. The average power of the signal over a time interval is computed by:

- a) Summing the power values at each point within the interval
- b) Dividing the sum by the number of points

This process is used to calculate Pulse Power, Average Power and the average power between markers.

Since each point represents the power over a finite time interval, the endpoints are handled separately to avoid spreading the interval by one-half pixel at each end of the interval (See Figure 6.4). For the interval in Figure 6.4, the average power is given by:

$$P_{ave} = \frac{1}{2}(P_0 + P_n) + \frac{1}{(n-1)} \sum_{n=1}^{n-1} P_n$$

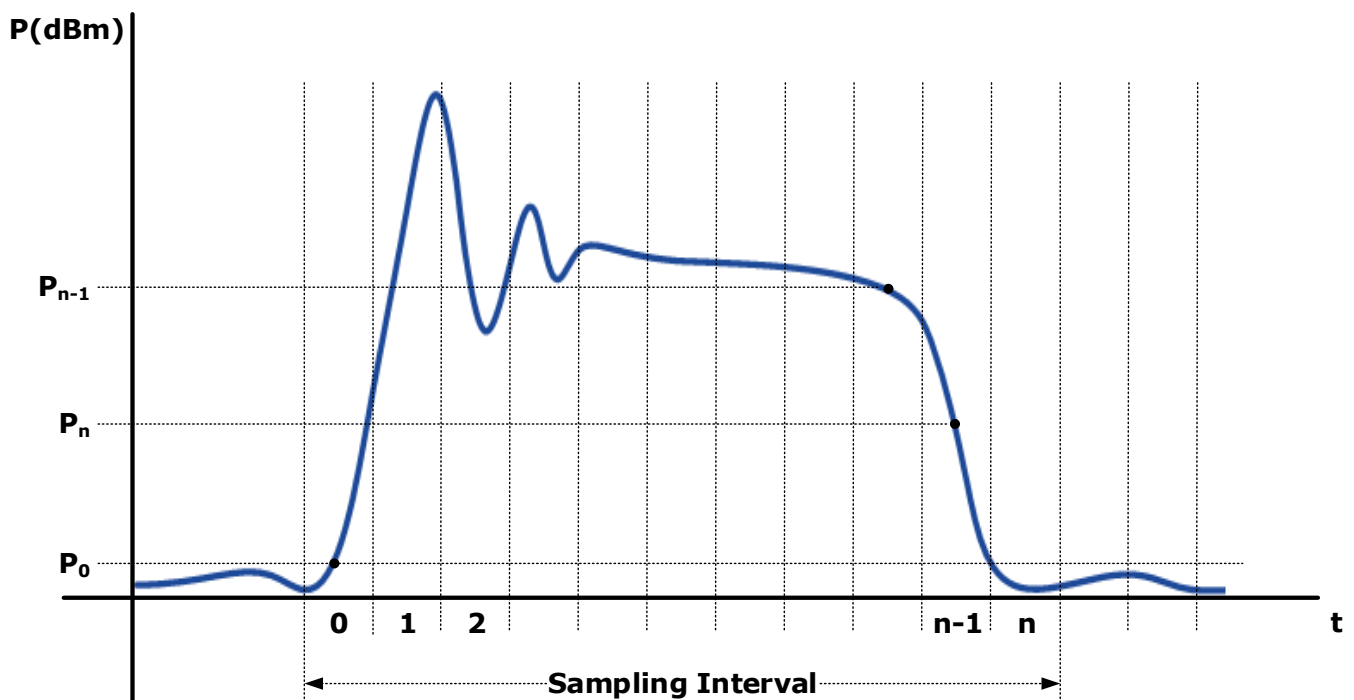

Figure 6.4 Sampling Intervals

14. To compute channel-to-channel Skew, the processor calculates the delay between the two measurement channels. The time reference for each channel is established by the first signal crossing (starting from the left edge of the screen) which passes through the mesial level (or 50% point in trigger view). The signal excursion must be at least 6 dB.

6.3 Automatic Statistical Measurements

Statistical Measurements based on the CCDF Graph are summarized in Table 6.5. (RTP5000 only)

Field Label	Parameter	Definition
10%	Power at 10% probability	Peak to average power corresponding to 10% probability
1%	Power at 1% probability	Peak to average power corresponding to 1% probability
0.1%	Power at 0.1% probability	Peak to average power corresponding to 0.1% probability
0.01%	Power at 0.01% probability	Peak to average power corresponding to 0.01% probability
0.001%	Power at 0.001% probability	Peak to average power corresponding to 0.001% probability
0.0001%	Power at 0.0001% probability	Peak to average power corresponding to 0.0001% probability
Pct at 0 dB	Probability (percent) at 0 dB	Probability corresponding to 0 dB on the CCDF Graph
Cursor Pct	Cursor Probability (percent)	Probability at the Cursor Position on the CCDF Graph
Cursor Pwr	Cursor Power	Peak to average power at the Cursor position on the CCDF Graph
Average	Average	The unweighted average of all power samples occurring since acquisition started
Max	Maximum	The highest power sample occurring since acquisition was started
Min	Minimum	The lowest power sample occurring since acquisition was started
Peak/Avg	Peak /Average Ratio	The ratio (in dB) of the Peak Power to the Average Power
Dynamic Range	Dynamic Range	The ratio (in dB) of the Peak Power to the Minimum Power

Table 6.5 Automatic Statistical Measurements

THIS PAGE INTENTIONALLY LEFT BLANK

7. Maintenance

This section presents procedures for maintaining the RTP Series Real-Time Power Sensors.

7.1 Safety Recommendation.

Although the RTP Series Real-Time Power Sensors have been designed in accordance with international safety standards, general safety precautions must be observed during all phases of operation and maintenance. Failure to comply with the precautions listed in the Safety Summary located in the front of this manual could result in serious injury or performance issues. Service and adjustments should be performed only by qualified service personnel.

Below is the safety recommendation for the RTP Series Real-Time Power Sensors:

- Only rotate the connector nut, DO NOT use the sensor body or device to tighten the connector.
- Do not overtighten the RF connector.
- Do not use a connector with deformed threads, or a bent or broken conductor.
- Do not touch mating-plane surfaces with oily, or wax-like non-conductive substances.
- Do not apply a lateral force to the center conductor.

7.2 Cleaning

Painted surfaces and the RF connector can be cleaned very carefully with a mild cleaning solution (a solution of pure isopropyl or ethyl alcohol) but make sure to keep in mind its flammable nature. Also you can use a clean, water-dampened cloth to clean the body of the RTP Series Real-Time Power Sensors.



CAUTION: When cleaning the power sensor, do not allow any liquid to enter into the device. Avoid using chemical cleaning agents which can damage painted or plastic surfaces.

7.3 Inspection and Performance Verification

If a RTP Series Real-Time Power Sensor malfunctions, perform a visual inspection of the instrument. Inspect for signs of damage caused by excessive shock, vibration or overheating. Inspect for broken or damaged connection port at sensor head, or accumulations of dust or other foreign matter. Correct any problems you discover and verify basic functionality with the **Power Analyzer Software**.

If desired, conduct a performance verification according to the procedure in the *RTP Series Real-Time Power Sensors Calibration and Verification Guide* to verify that the instrument is properly recognized by the Windows OS and operational. If the malfunction persists or the sensor device fails the performance verification, contact Boonton Electronics for service.

7.4 Connector Care

The most common cause of power sensor problems is excess input power. Applying power exceeding the labeled damage levels will damage the sensing elements such that its voltage versus power relationships are changed, resulting in erroneous power readings. The other most common cause of power sensor problems is damaged connectors. Connections should be tightened with the proper torque wrench applied to the coupling nut only. Any

attempt to torque or un-torque a connection using the body of the power sensor may result in either connector damage, or in the connector becoming unthreaded from the body.

The following handling precautions must be observed to prevent connector damage when using RTP Series Real-Time Power Sensors.

- Keep connectors clean and protect using the plastic end caps provided with each sensor.
- Inspect connectors regularly and look for metal debris, scratches or dents.
- Clean contact surface and threads with clean, dry compressed air.
- Align connectors first and only rotate the connector nut.
- Always follow MIL-C-39012 standards for making a connection
- A MIL-C-39012 or precision type “N” connector is recommended for the RF line signal source connection.
- After proper alignment, rotate the connector nut by hand to connect or disconnect the connector of the sensor from a signal source as shown in Figure 7.1.

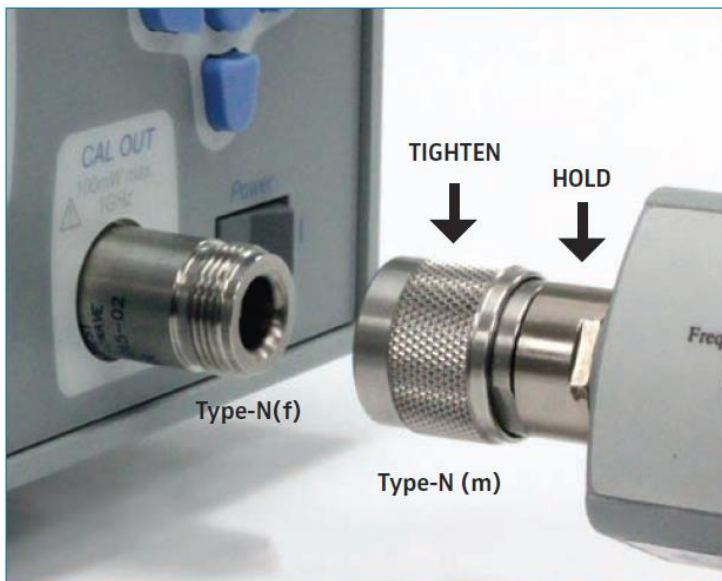

Figure 7.1 Hold the connector body while rotating the knurled nut to tighten or loosen the connector.

- If the connector nut is not equipped with a hex, it should be hand tightened only.
- Do not over-tighten the connector by using the sensor body for additional leverage.
- Avoid mechanical shock.
- Avoid applying excessive power.
- Observe proper ESD (electrostatic discharges) precautions.

7.5 Software and Firmware Updates

Power Analyzer Software included the ability to check online for updates to both itself and the firmware in connected RTP Series Real-Time Power Sensors.

7.5.1 Firmware Update Procedure

On the main menu bar select the View tab then click the “Check For Updates” button.

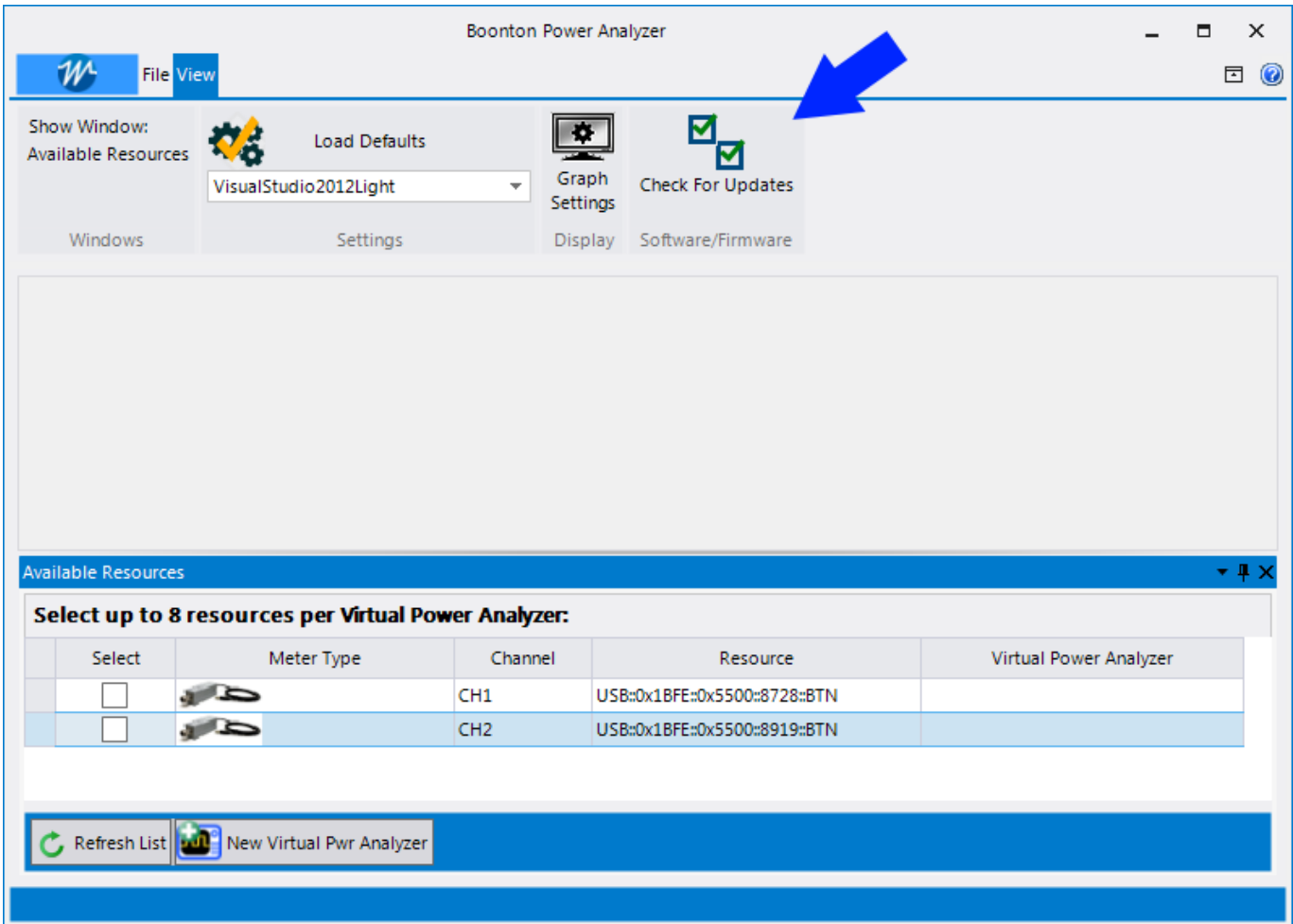

Figure 7.2 The Check for Update button is used to check for available firmware and software updates.

The Software Updates popup will appear. In the row labeled “RTP Series ... Firmware”, click the “Launch” button.

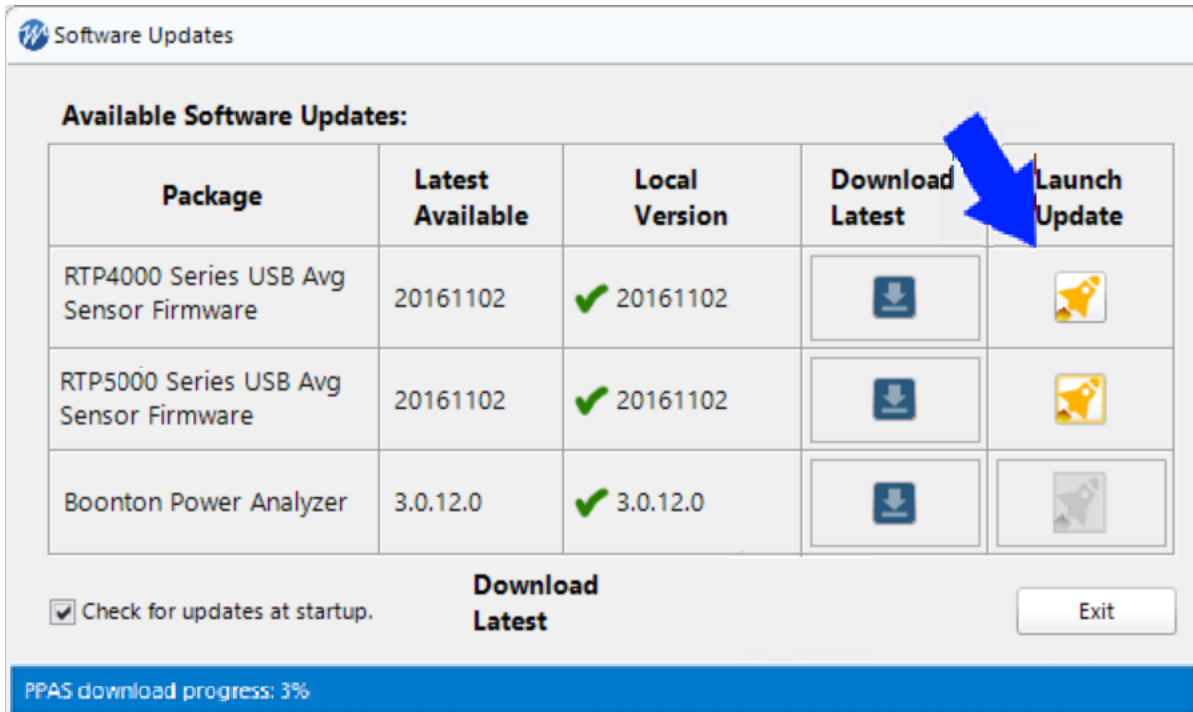

Figure 7.3 The Software available popup is used to select updates of either the RTP Series Real-Time Power Sensors firmware or the **Power Analyzer Software**.



NOTE: Firmware current with the release of the **Power Analyzer Software** is embedded in the program and does not have to be downloaded.

The “Select Sensor” popup will appear. Select the desired sensor from the drop-down and click “OK”.

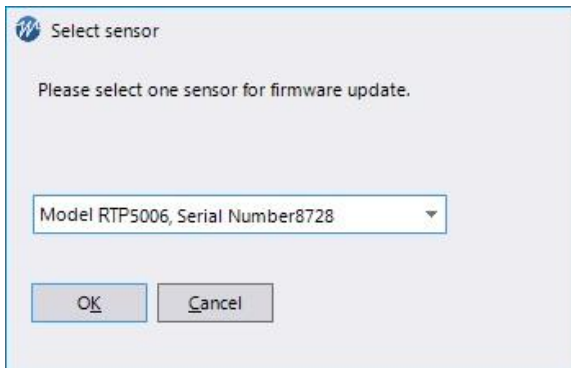

Figure 7.4 Selecting sensor for firmware update. A dialog will appear and the firmware update will begin. This process will take several minutes, and a progress bar will indicate programming.

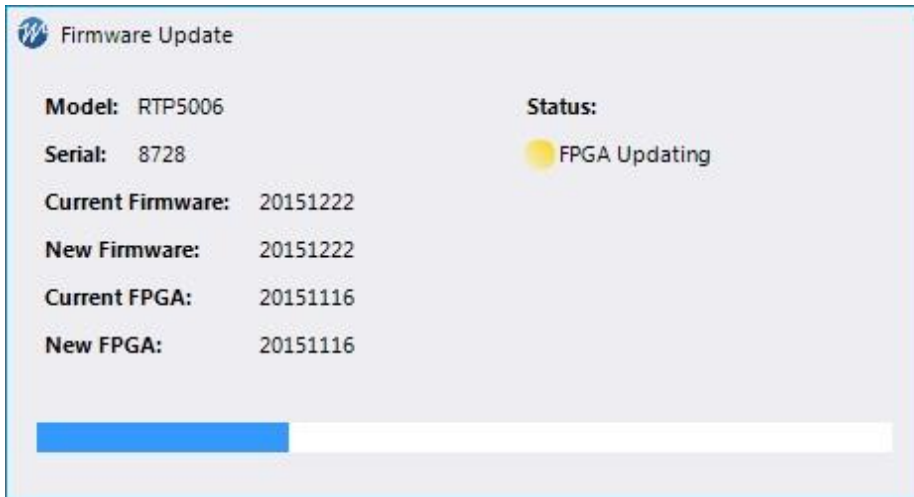

Figure 7.5 The firmware update progress bar

Following successful firmware update, a status dialog will be displayed.

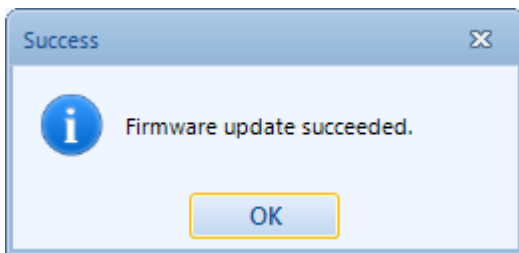

Figure 7.6 Firmware update succeeded

7.5.2 Power Analyzer Software Update Procedure

On the main menu bar select the View tab then click the “Check For Updates” button.

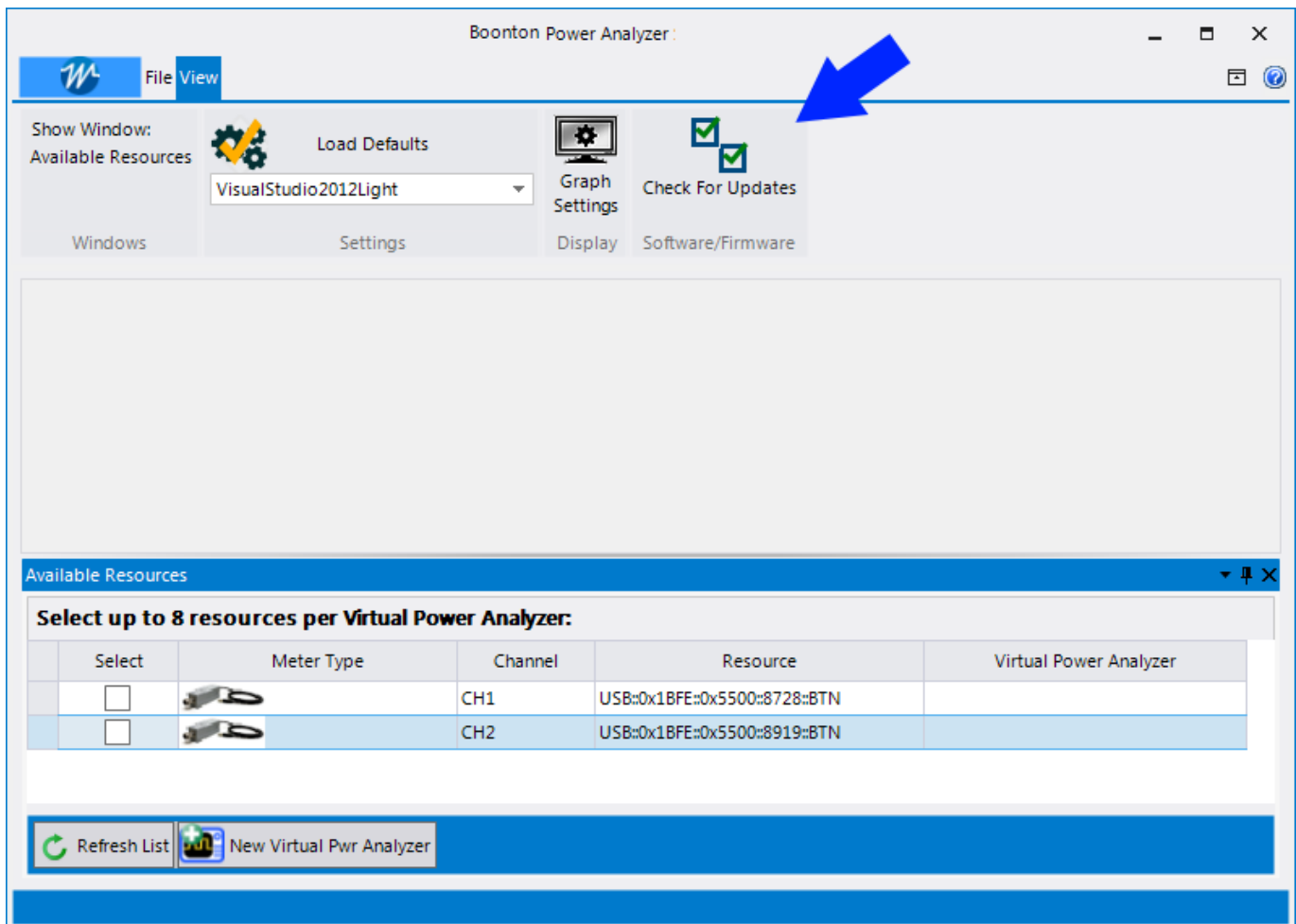

Figure 7.7 Checking for the **Power Analyzer Software** for software updates

The “Available Software Updates” popup will appear. In order to upgrade the software, you must first download the update. In the row labeled “Boonton Power Analyzer”, click the “Download” button.

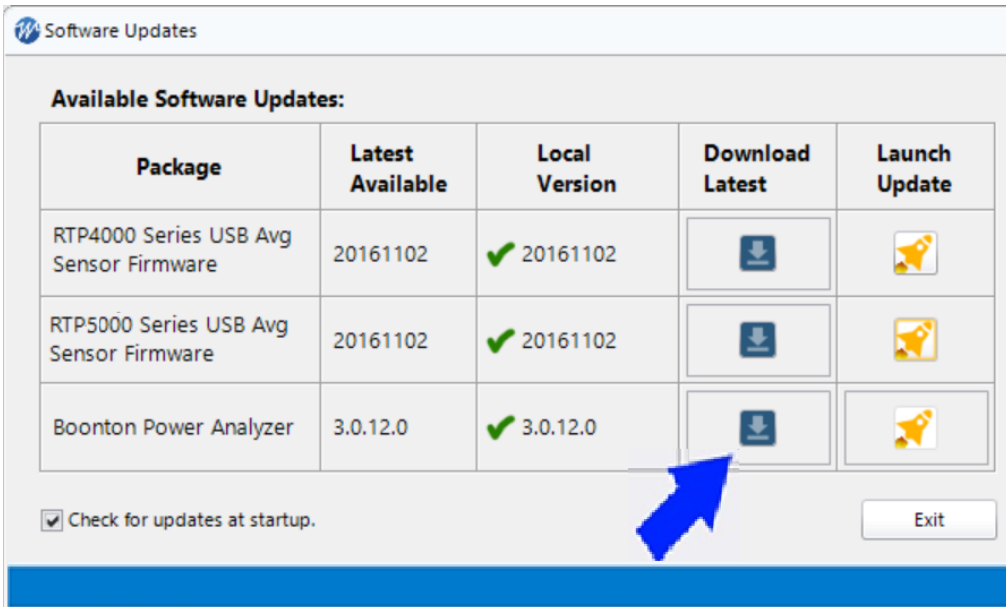

Figure 7.8 Download the **Power Analyzer Software**.

A save file dialog box will appear. Choose the location you wish to save the software update.

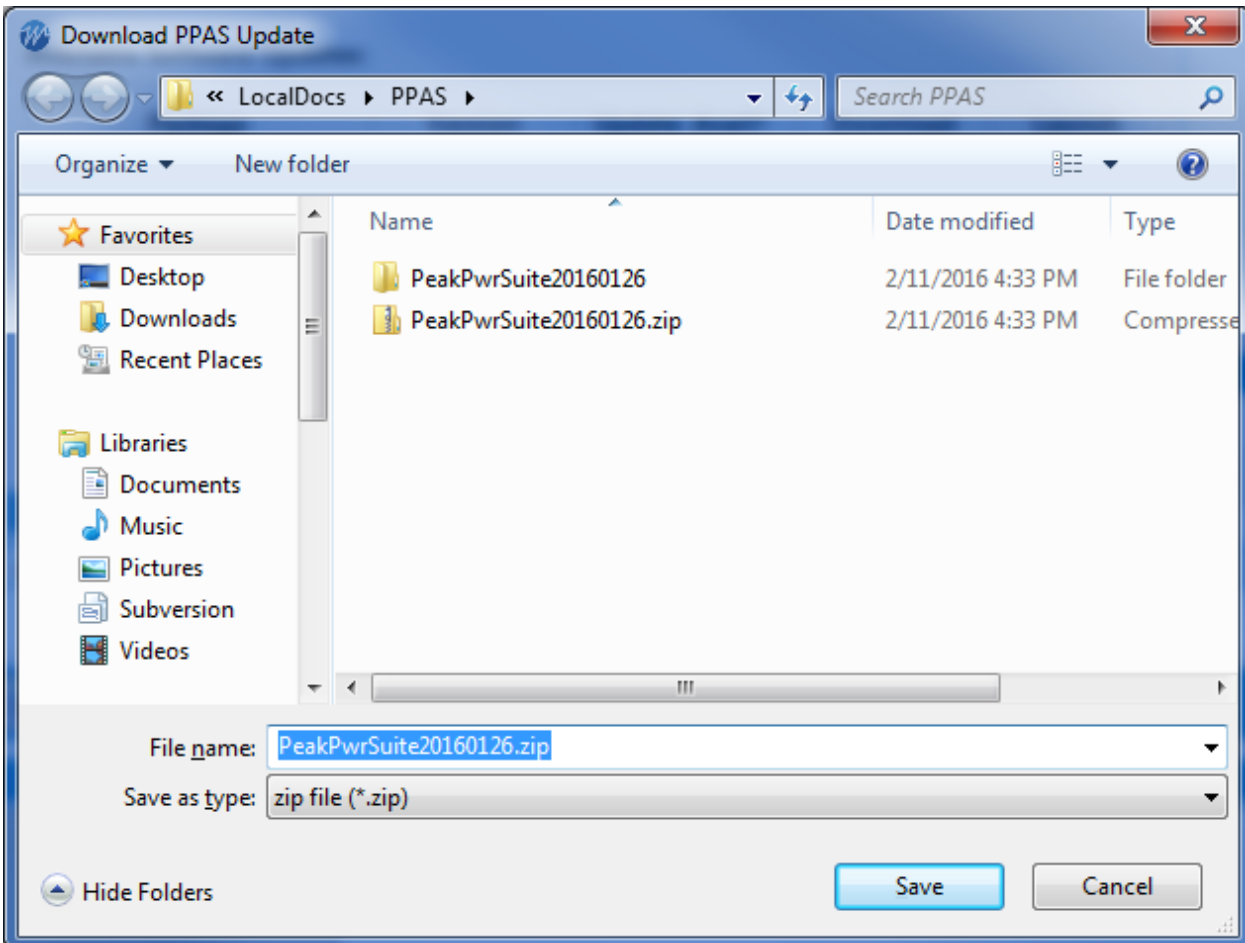

Figure 7.9 Saving the downloaded software to a selected file location

The following message will appear when the download completes.

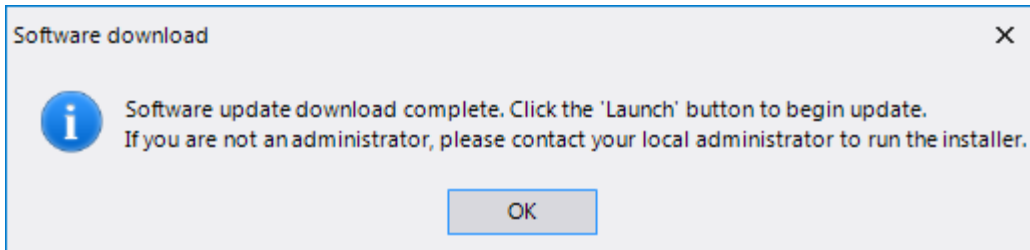

Figure 7.10 Indication that the download has been completed.

Click the “Launch” button to begin the upgrade.

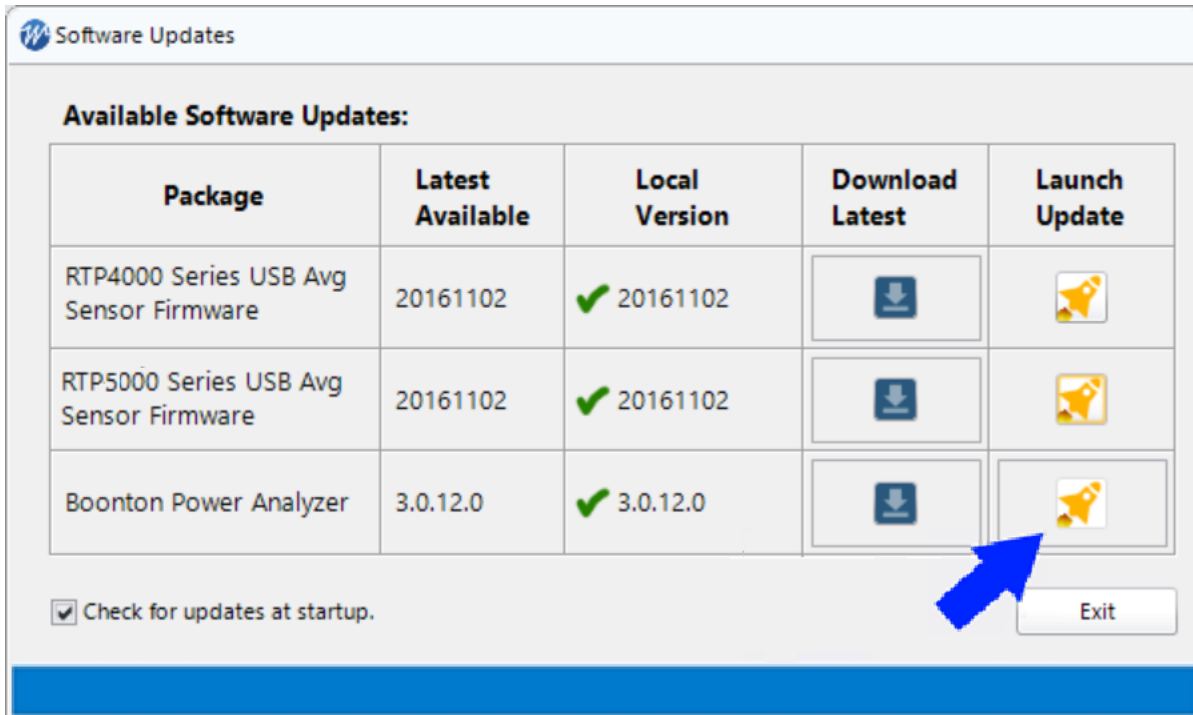

Figure 7.11 Launch button begins the **Power Analyzer Software** update.

A progress bar will appear in the “Launch” column. Before the upgrade begins, the update package must be unzipped. This process will take several minutes.

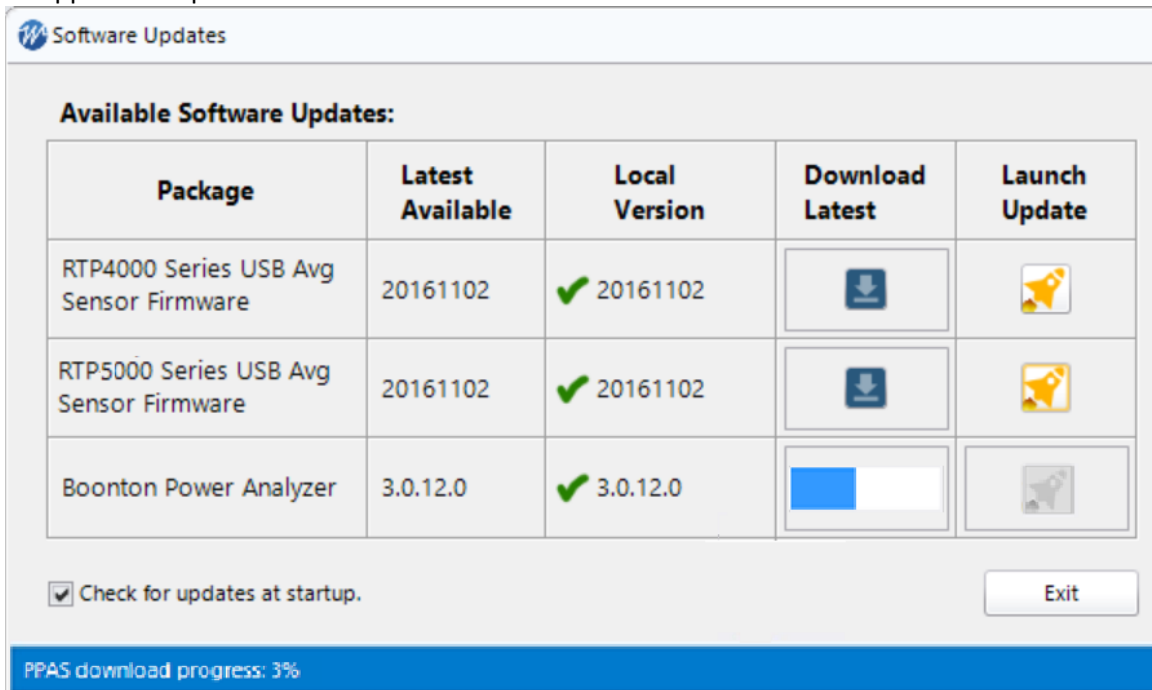

Figure 7.12 The progress bar appears while the software is being updated

Once the installation begins, the **Power Analyzer Software** update will close and the following window will appear.

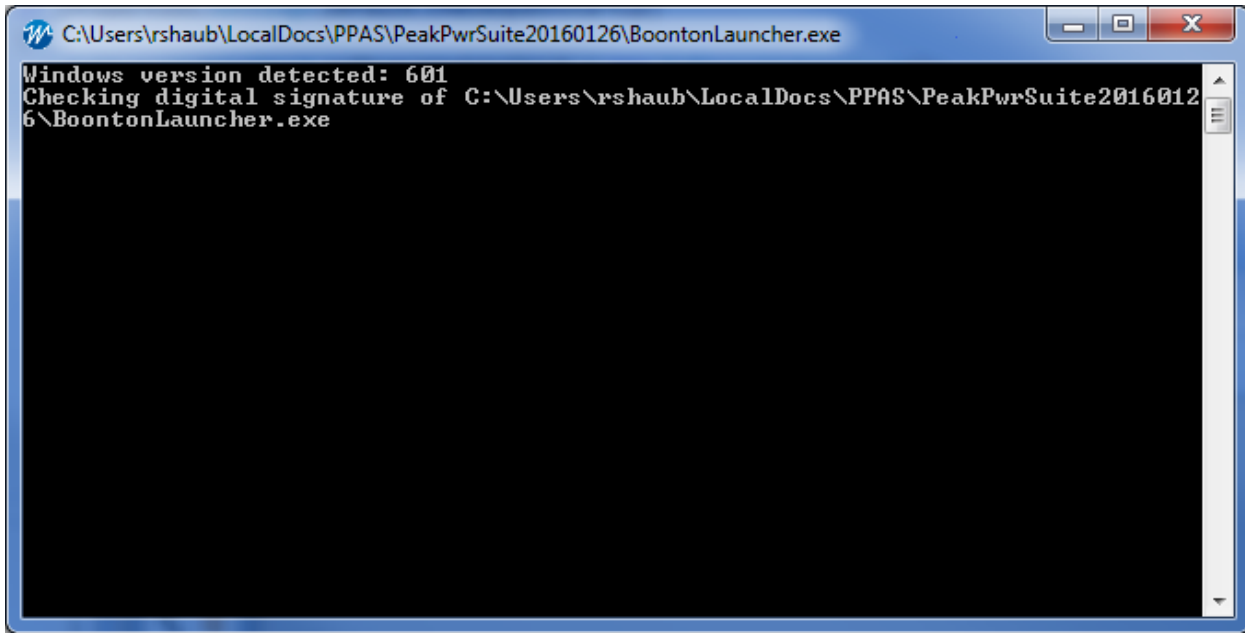

Figure 7.13 This window will appear as the software is updated.

Next, the installer will begin. Follow the prompts to complete the installation.

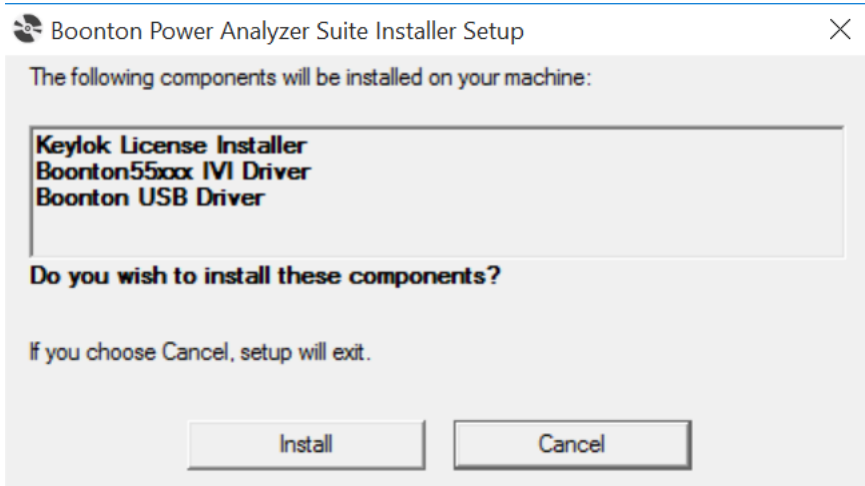

Figure 7.14 Click *Install* to begin the software installation. Confirm any additional prompts if needed.

Checking for new Firmware after the Initial Installation

When new features are added to the **Power Analyzer Software**, a sensor firmware update is sometimes required to fully support the new capabilities. After the update of the **Power Analyzer Software**, it is recommended that users check for new firmware using the following procedure.

On the main menu bar select the View tab then click the “Check for Updates” button

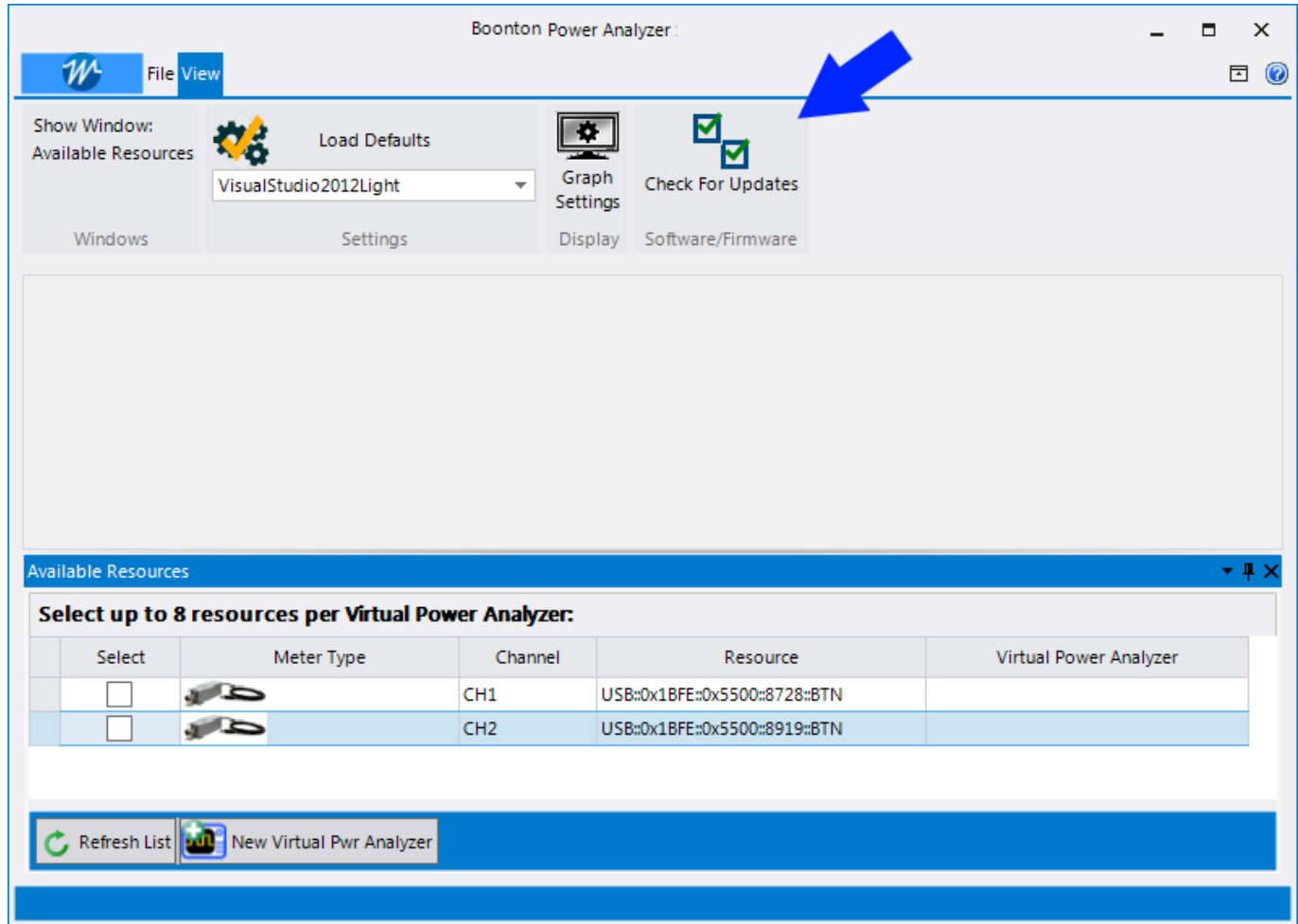

Figure 7.15 Checking for available firmware upgrades

If a new version of firmware is available, there will be a yellow triangle with an exclamation point next to the version under “Local Version”.

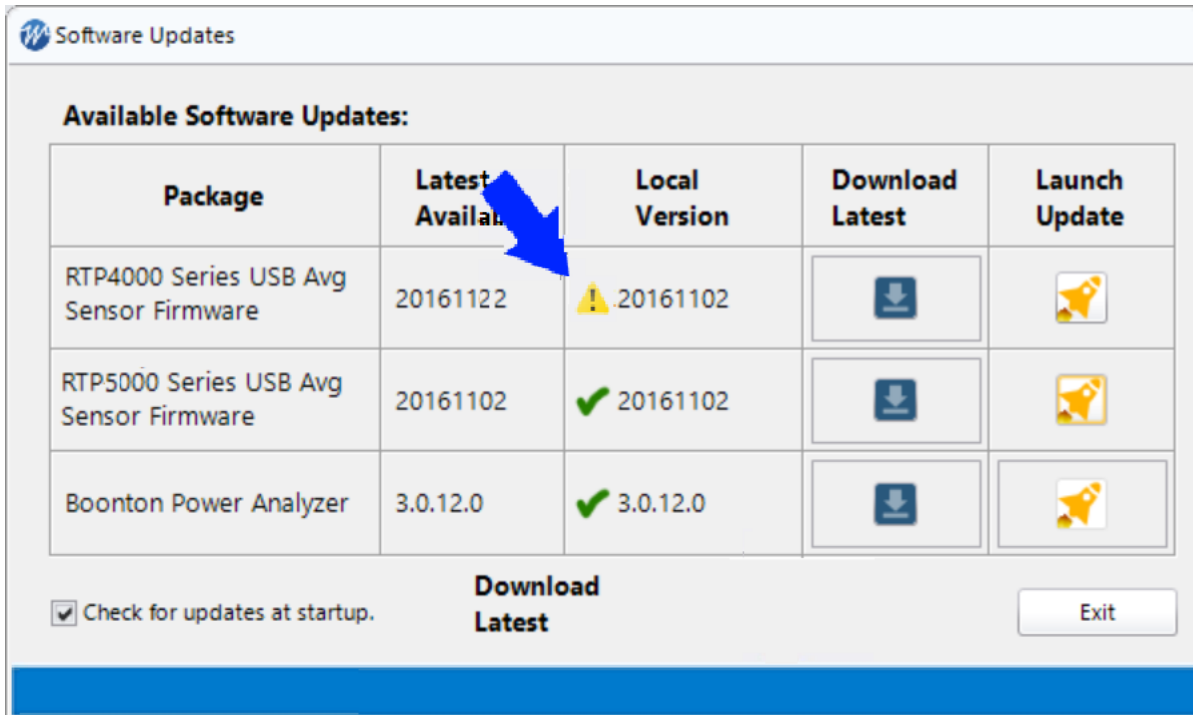

Figure 7.16 The yellow triangle icon indicates a firmware upgrade is available.

To begin downloading the newest firmware images, click the download button.

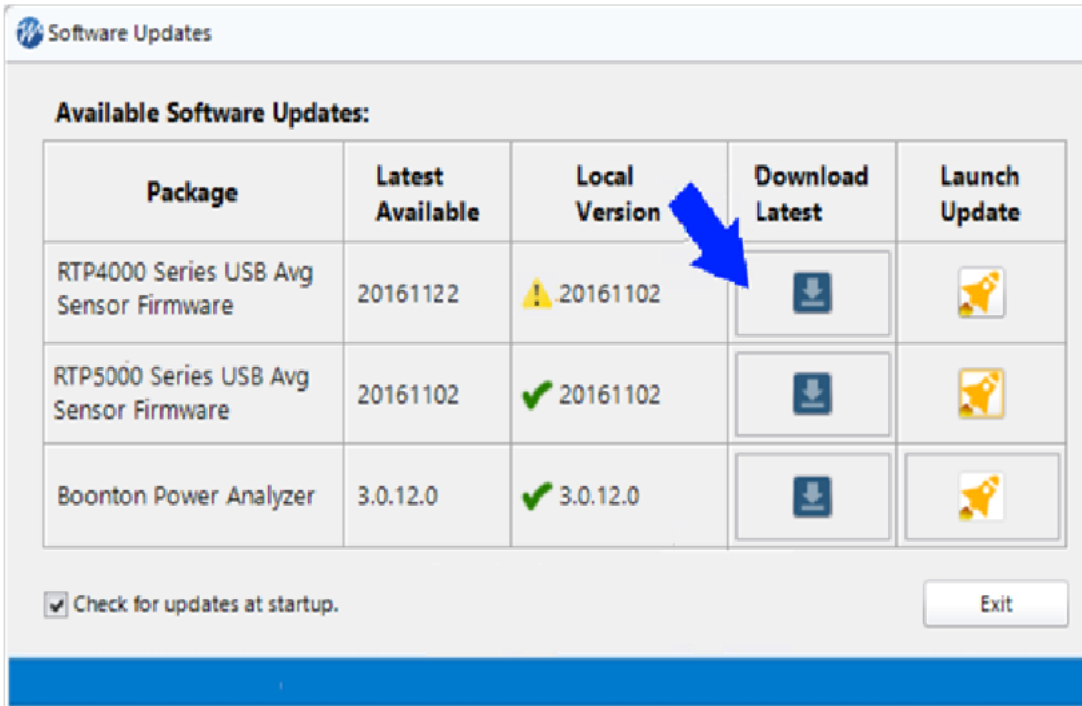

Figure 7.17 Press the download button to begin downloading the firmware.

A progress bar will appear in the “Download” column. This process may take several minutes.

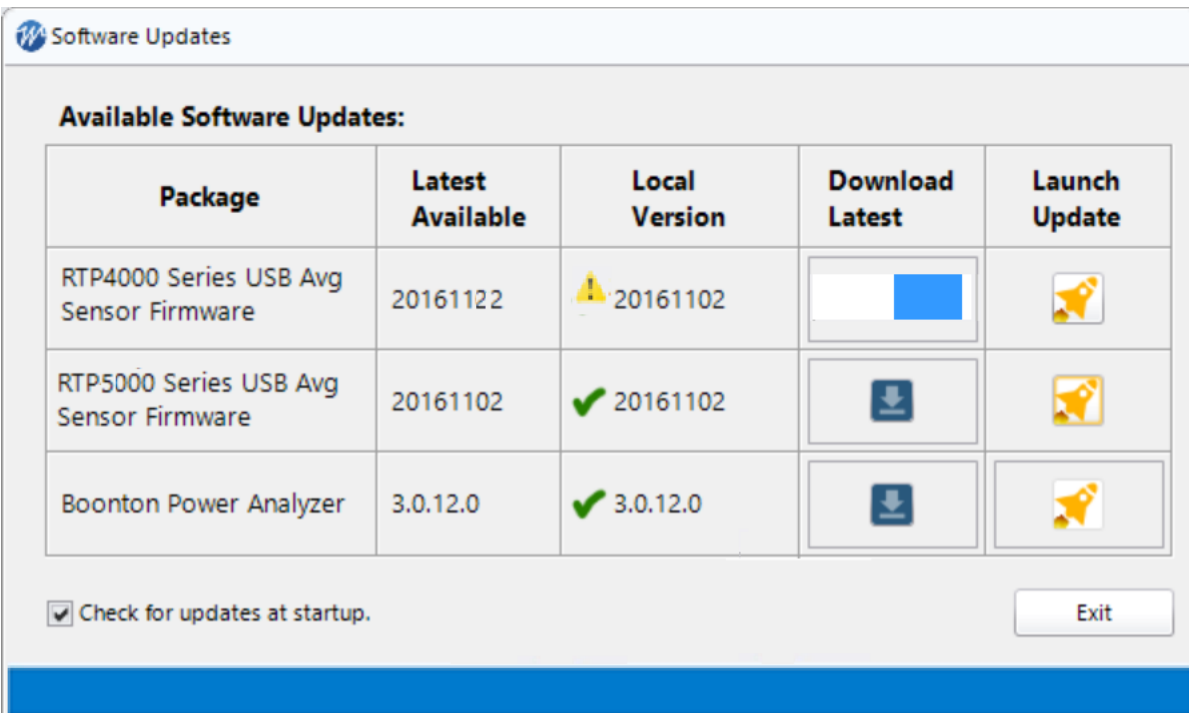

Figure 7.18 Waiting for the firmware download.

Once the download is complete, a green check mark will appear next to the firmware version number.

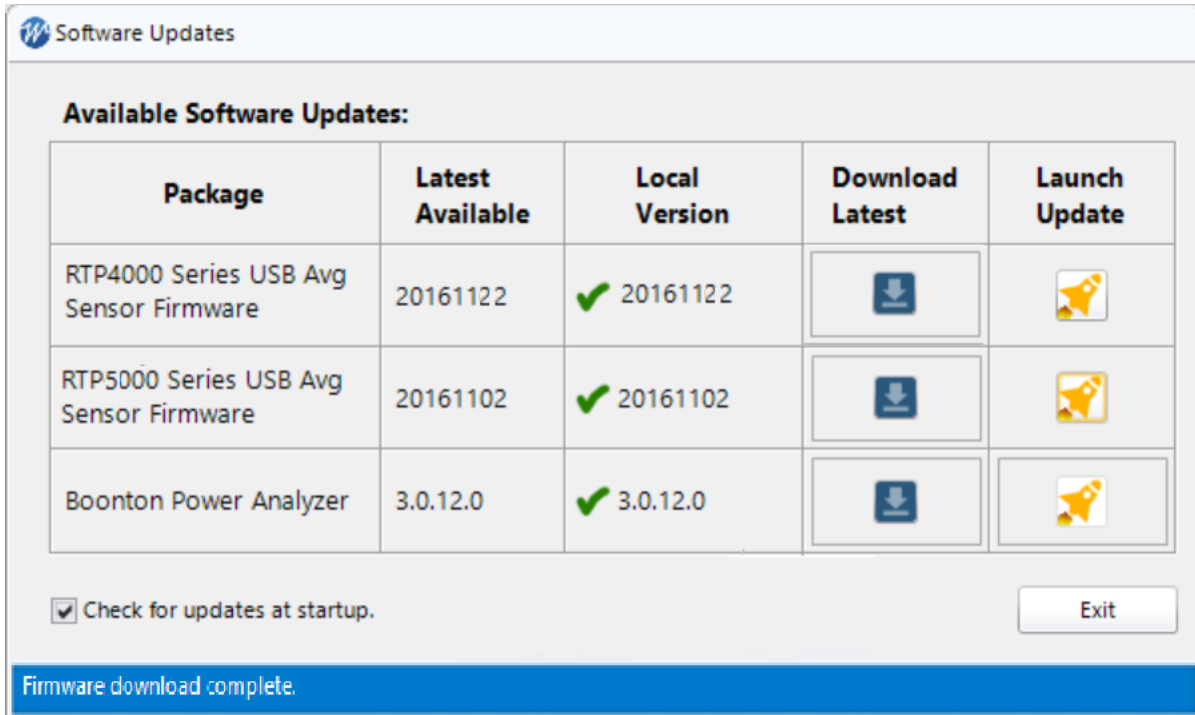

Figure 7.19 The green checkmark indicates that the new firmware is current.

8. Appendix A Software Licenses

8.1 End User Licence Agreement (EULA)

License below is hereby granted for the following product(s):

- Firmware for RTP Sensors
- Power Analyzer Software

IMPORTANT-READ CAREFULLY: This End-User License Agreement ("EULA") is a legal agreement between you (either an individual or a single entity) and Boonton Electronics, a subsidiary of the Wireless Telecom Group, Inc., for the Boonton Electronics software product identified above, which includes instrument software and may include associated media, printed materials, "online" or electronic documentation, and Internet-based services ("Product"). An amendment or addendum to this EULA may accompany the Product.

YOU AGREE TO BE BOUND BY THE TERMS OF THIS EULA BY INSTALLING, COPYING, OR OTHERWISE USING THE PRODUCT. IF YOU DO NOT AGREE, DO NOT INSTALL OR USE THE PRODUCT; YOU MAY RETURN IT TO YOUR PLACE OF PURCHASE FOR A FULL REFUND.

1. **GRANT OF LICENSE.** Boonton Electronics grants you the following rights provided that you comply with all terms and conditions of this EULA:

*Installation and use. You may install, use, access, display and run this Product only in conjunction with RTP Series Real-Time Power Sensors and 55 series sensors. The Product may not be used on any other hardware.

*Reservation of Rights. Boonton Electronics reserves all rights not expressly granted to you in this EULA.

2. **UPGRADES.** To use a Product identified as an upgrade, you must first be licensed for the product identified by Boonton Electronics as eligible for the upgrade. After upgrading, you may continue to use the product that formed the basis for your upgrade eligibility.
3. **TRANSFERABILITY.** This product is transferable only to other Boonton models listed in Paragraph 1.
4. **LIMITATION ON REVERSE ENGINEERING, DECOMPILATION, AND DISASSEMBLY.** You may not reverse engineer, decompile, or disassemble the Product, except and only to the extent that it is expressly permitted by applicable law notwithstanding this limitation.
5. **TERMINATION.** Without prejudice to any other rights, Boonton Electronics may cancel this EULA if you do not abide by the terms and conditions of this EULA, in which case you must destroy all copies of the Product and all of its component parts.
6. **NOT FOR RESALE SOFTWARE.** This software product is "Not for Resale" and may not be separately resold, transferred or used for any purpose other than operation with Boonton instrument models listed in the paragraph 1.
7. **EXPORT RESTRICTIONS.** You acknowledge that the Product is of U.S. origin and subject to U.S. export jurisdiction. You agree to comply with all applicable international and national laws that apply to the Product, including the U.S. Export Administration Regulations, as well as end-user, end-use, and destination restrictions issued by U.S. and other governments.

8. U.S. GOVERNMENT LICENSE RIGHTS. All Product provided to the U.S. Government pursuant to solicitations issued on or after December 1, 1995 is provided with the commercial license rights and restrictions described elsewhere herein. All Product provided to the U.S. Government pursuant to solicitations issued prior to December 1, 1995 is provided with "Restricted Rights" as provided for in FAR, 48 CFR 52.227-14 (JUNE 1987) or DFAR, 48 CFR 252.227-7013 (OCT 1988), as applicable.
9. APPLICABLE LAW. If you acquired this Product in the United States, this EULA is governed by the laws of the State of New Jersey. If this Product was acquired outside the United States, then local law may apply.
10. ENTIRE AGREEMENT. This EULA (including any addendum or amendment to this EULA which is included with the Product) are the entire agreement between you and Boonton Electronics relating to the Product and the support services (if any) and they supersede all prior or contemporaneous oral or written communications, proposals and representations with respect to the Product or any other subject matter covered by this EULA. To the extent the terms of any Boonton Electronics policies or programs for support services conflict with the terms of this EULA, the terms of this EULA shall control.
11. The Product is protected by copyright and other intellectual property laws and treaties. Boonton Electronics owns the title, copyright, and other intellectual property rights in the Product. The Product is licensed, not sold.

8.2 Open Source Attributions

SharpDX Copyright (c) 2010-2015 SharpDX, Alexandre Mutel (MIT License)

PDFsharp Copyright (c) 2005-2014 empira Software GmbH, Troisdorf, Germany (MIT License)

MIT License

Permission is hereby granted, free of charge, to any person obtaining a copy of this software and associated documentation files (the "Software"), to deal in the Software without restriction, including without limitation the rights to use, copy, modify, merge, publish, distribute, sublicense, and/or sell copies of the Software, and to permit persons to whom the Software is furnished to do so, subject to the following conditions:

The above copyright notice and this permission notice shall be included in all copies or substantial portions of the Software.

THE SOFTWARE IS PROVIDED "AS IS", WITHOUT WARRANTY OF ANY KIND, EXPRESS OR IMPLIED, INCLUDING BUT NOT LIMITED TO THE WARRANTIES OF MERCHANTABILITY, FITNESS FOR A PARTICULAR PURPOSE AND NONINFRINGEMENT. IN NO EVENT SHALL THE AUTHORS OR COPYRIGHT HOLDERS BE LIABLE FOR ANY CLAIM, DAMAGES OR OTHER LIABILITY, WHETHER IN AN ACTION OF CONTRACT, TORT OR OTHERWISE, ARISING FROM, OUT OF OR IN CONNECTION WITH THE SOFTWARE OR THE USE OR OTHER DEALINGS IN THE SOFTWARE.

9. Appendix B Warranty & Repair

9.1 Repair Policy

If RTP Series Real-Time Power Sensor is not operating correctly and requires service, contact the Boonton Electronics Service Department as indicated in **Section 9.2 Contacting Boonton** for return authorization. You will be provided with an RMA number and shipping instructions. Customers outside the USA should contact the authorized Boonton distributor for your area. The entire instrument must be returned in its original packing container. If the original container is not available, Boonton Electronics will ship a replacement container and you will be billed for the container cost and shipping charges. See section 2.1 of this manual for packing instructions.

Note that sensors which have failed due to overloading, improper mating, or connecting to an out-of-tolerance connector are not considered defective and will not be covered by the Boonton Warranty.

9.2 Contacting Boonton

RMAs for service or calibration may be obtained directly from the Boonton website.

Customers in the United States having questions or equipment problems may contact Boonton Electronics directly during business hours (8 AM to 5 PM Eastern) by phoning (973) 386-9696.

Email inquiries should be sent to service@boonton.com. International customers should contact their authorized Boonton Electronics representative for assistance. A current list of authorized US and international representatives is available on the Boonton website at www.boonton.com.

9.3 Limited Warranty

Boonton Electronics warrants its products to the original Purchaser to be free from defects in material and workmanship and to operate within applicable specifications for a period of three years from date of shipment for instruments, probes, power sensors and accessories. Boonton Electronics further warrants that its instruments will perform within all current specifications under normal use and service for one year from date of shipment. These warranties do not cover active devices that have given normal service, sealed assemblies which have been opened, or any item which has been repaired or altered without Boonton's authorization.

Boonton's warranties are limited to either the repair or replacement, at Boonton's option, of any product found to be defective under the terms of these warranties.

There will be no charge for parts and labor during the warranty period. The Purchaser shall prepay inbound shipping charges to Boonton or its designated service facility and shall return the product in its original or an equivalent shipping container. Boonton or its designated service facility shall pay shipping charges to return the product to the Purchaser for domestic shipping addresses. For addresses outside the United States, the Purchaser is responsible for prepaying all shipping charges, duties and taxes (both inbound and outbound).

At Boonton's option, an extended Warranty period may be available for an additional charge. If an extended warranty option has been purchased, the extended period is substituted for the 1 year period above. Note that the extended warranty does not extend the instrument's calibration interval past 12 months. The instrument must be maintained in a calibrated state throughout the warranty period to be eligible for warranty service to remedy "out of spec" operation.

THE FOREGOING WARRANTIES ARE IN LIEU OF ALL OTHER WARRANTIES, EXPRESS OR IMPLIED, INCLUDING, BUT NOT LIMITED TO, THE IMPLIED WARRANTIES OF MERCHANTABILITY AND FITNESS FOR A PARTICULAR PURPOSE. Boonton will not be liable for any incidental damages or for any consequential damages, as defined in Section 2-715 of the Uniform Commercial Code, in connection with products covered by the foregoing warranties

END OF RTP-SERIES INSTRUCTION MANUAL