

Manual

For Operation



AN 200 Series

Voltage Transient Emission Test

- AN 200
- AN 200B

The AN 200 is used to evaluate automotive electrical and electronic components for conducted emissions of transients along battery fed or switched supply lines of a Device Under Test (DUT). A device under test which is considered a potential source of conducted disturbances should be tested according to ISO 7637 part 2.

The AN 200 includes an electronic switch for repeatable switching of inductive loads as well as an artificial network as specified in ISO.

- ISO 7637 Part 2



Contens

1.	Standards covered by AN 200	3
1.1.	Family Series AN 200	3
2.	Operating Functions	4
2.1.	Front view.....	4
2.2.	Rear view	6
3.	Equipment description	7
3.1.	Switch Normal, Switch and Artificial Network	7
3.2.	Electronic switch	8
3.3.	Ersatzwiderstand.....	8
3.4.	Artificial network	9
4.	Technical Data	10
5.	Calibration / Measuring procedure	11
5.1.	Test load	11
5.2.	Test voltage.....	11
5.3.	Switch-off times	11
5.4.	Blockdiagram	11
5.5.	Measuring results.....	12
5.5.1.	Voltage drop in dependence of the test load	12
5.5.2.	Measuring results with calibration according to standards	12
6.	Maintenance	13
6.1.	General.....	13
6.2.	Function check.....	13
6.3.	Test setup	13
6.4.	Safety aspects.....	13
7.	Delivery Groups	14
7.1.	Basic equipment.....	14
7.2.	Options	14
8.	Appendix	15
8.1.	Declaration of CE-Conformity	15
8.2.	AN 200 - Overview	16

1. Standards covered by AN 200

With the AN 200 the user covers the following standards for conducted emission transients:

- **ISO 7637 Teil 2** **Road vehicles; Electrical disturbances by conduction and coupling ;**
Part 2 : Electrical transients conduction along supply lines only
- **several standards** **In accordance with ISO 7637 Teil 2**

1.1. Family Series AN 200

This manual is written for the following devices:

AN 200 30V 35A

AN 200 B 60V 50A

2. Operating Functions

2.1. Front view

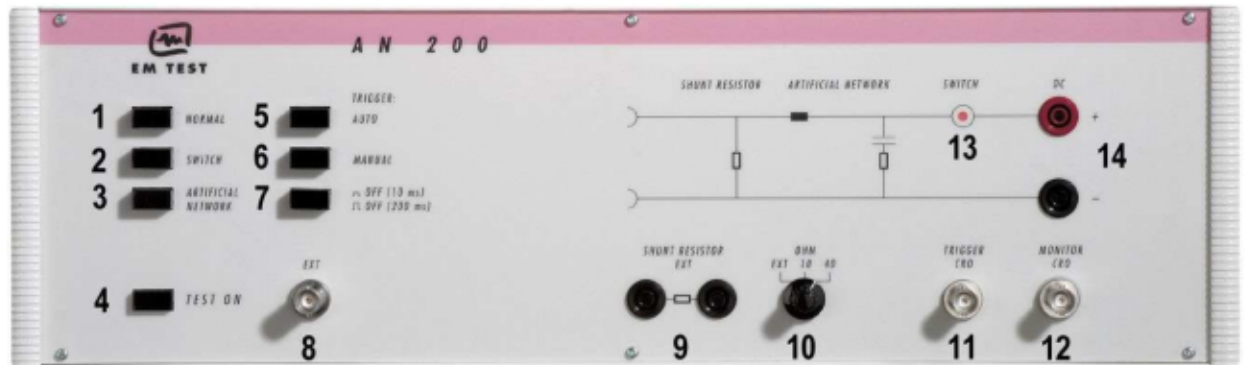

Figure 1 : AN200 front side

- | | | |
|--------------------------------|--------------------------------------|---------------------------------|
| 1 NORMAL operation | 6 MANUAL Trigger | 11 CRO Trigger (output) |
| 2 Switch operation | 7 Selection of time off | 12 CRO measuring output (1:100) |
| 3 Artificial network operation | 8 External Trigger | 13 LED indication switch-on |
| 4 TEST ON | 9 Connection external shunt resistor | 14 Connection DUT |
| 5 AUTO Trigger | 10 Selection of shunt resistor | |

1 Normal operation

By pressing the „**NORMAL**“ button the electronic battery supply switch and the artificial network are both in operation. Pushing the **TEST ON** button will start the procedure.

2 Switch operation

By pressing the „**SWITCH**“ button the electronic battery supply switch is put into operation. Pushing the **TEST ON** button will start the switching operations. The artificial network is not used in this mode of operation. (the switch may be used together with the LD 200 for generate Field Decay pulses; read details in the LD 200B manual)

3 Artificial network operation

By pressing the „**ARTIFICIAL NETWORK**“ button the artificial network is put into operation. The electronic battery supply switch is short-circuited. The AN 200 can be used as an artificial network only.

4 TEST ON

By pushing the **TEST ON** button the electronic battery supply switch is put into operation. The switch starts working with the preselected triggering parameters.

5 AUTO Trigger

By pushing the „**AUTO**“ button the switching procedures (battery supply OFF – ON) are released in automatically with a repetition rate of 1Hz. To start the test or measuring procedure the **Test On** button must be pushed in.

6 MANUAL Trigger

In Manual Trigger operation (**AUTO** button must not be pushed in) a single switching event, OFF – ON. To start the test or measuring procedure the **Test On** button must be pushed in.

7 Selection of the OFF-time

The operator can select the OFF-time by pushing the button 200ms / 10ms" into the related position. The user can select between 200ms and 10ms.

8 External Trigger

In Manual Trigger operation (**AUTO** button must not be pushed in) a single switching event, OFF-ON can be released by remote control. The external trigger input at the BNC connector **EXT** must be connected to ground (short-circuit) to release one single event.

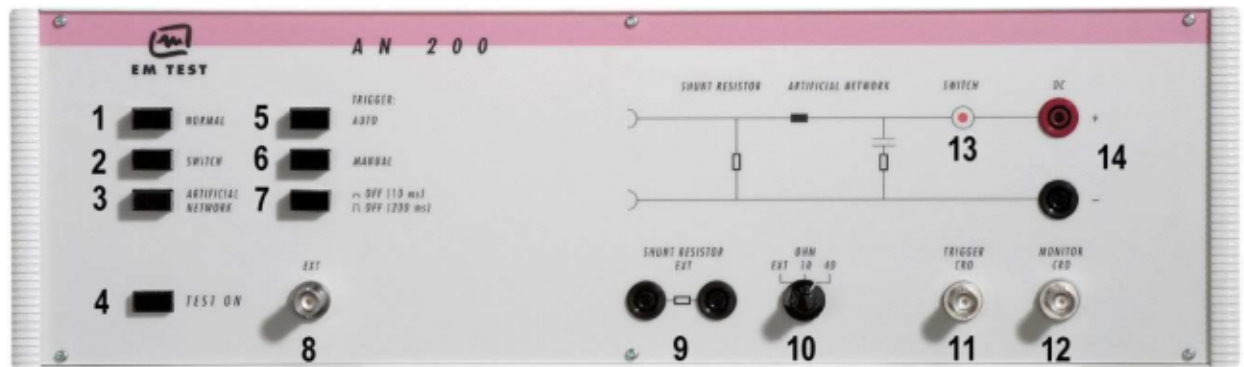

Figure 1 : AN200 front side

- | | | | | | |
|---|------------------------------|----|------------------------------------|----|------------------------------|
| 1 | NORMAL operation | 6 | MANUAL Trigger | 11 | CRO Trigger (output) |
| 2 | Switch operation | 7 | Selection of time off | 12 | CRO measuring output (1:100) |
| 3 | Artificial network operation | 8 | External Trigger | 13 | LED indication switch-on |
| 4 | TEST ON | 9 | Connection external shunt resistor | 14 | Connection DUT |
| 5 | AUTO Trigger | 10 | Selection of shunt resistor | | |

9 Connections of external shunt resistors

An external shunt resistor of $R = 2.5\Omega / 400W$ (at $U = 30VDC$) may be connected to the related safety banana sockets. Together with the existing incorporated resistors it results a total resistor value of 2Ω . The 2Ω value is required when measuring transient emissions as per ISO/DIN 7637 standard.

10 Selection of the shunt resistor

With this knob the shunt resistor can be switched to 40Ω , 10Ω or to an external resistor (see point 9.)

11 CRO Trigger

During the switching-off ramp a trigger signal (+ 15V) is generated and is available at the **CRO Trigger** output.

12 CRO measuring output

The measured transient emission signal is available at the **Monitor** output. The AN 200 includes a resistive divider with a divider ratio of 1:100 and an accuracy of $\pm 2\%$.

13 LED display indication of Switch-On status

The LED indicates the On-status of the electronic battery supply switch. In this case the DUT is connected to battery supply.

14 Connection for device under test (DUT)

The DUT is connected at the safety banana output sockets.

2.2. Rear view



Figure 2 : AN 200 rear side

- | | | | |
|---|----------------------------|---|---------------------------|
| 1 | Ventilation grid | 4 | Measuring output BNC plug |
| 2 | Reference earth connection | 5 | Power On switch |
| 3 | Input DUT supply | | |

1 Ventilation

This guarantees cooling of the battery supply switch. Ventilation grid and ventilator (blower) must be kept away from other devices in order to allow sufficient air flow through the battery supply switch.

2 Reference earth connection

This plug is for connecting the AN 200 to the ground reference plane.

3 DUT supply

The battery supply (+) & (-) for the DUT is connected to this input. The nominal dc supply parameters allowed are 30V / 25A .

4 Measuring output with 50 Ω coaxial resistor

For measuring conducted emission spectrum on battery supply lines as per ISO/DIN 7637 and DIN/VDE 0879 an artificial network, as illustrated in chapter 3.3, is compulsory. For this the required the 50 Ω resistor R_z is coaxial and located on the BNC plug.

For measuring the interference spectrum a test receiver or spectrum analyzer with 50 Ω input impedance is used. The instrument is connected to this BNC socket and the 50 Ω coaxial resistor is replaced by the 50 Ω input impedance of the measuring device.

5 Power on switch

The switch is part of the mains filter. Mains fuses are part of the filter. 230V / 1A and 115V / 2A

3. Equipment description

The battery supply switch AN 200 is generally divided into three main parts:

- Electronic switch;
- Shunt resistor RS;
- Artificial network.



Bild 3: Blockschaltbild

3.1. Switch Normal, Switch and Artificial Network

Depend of the switching position the AN 200 offers different networks. By switching of one of the switches will release automatically the others. They will go into normal position.

Normal

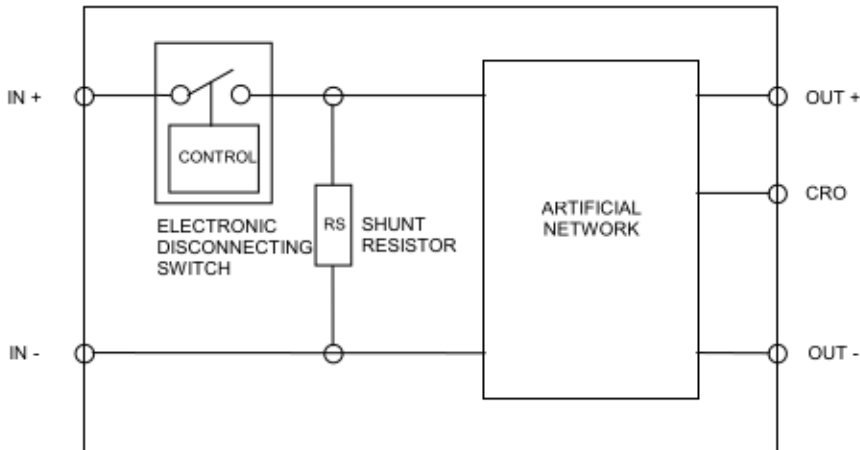
The internal switch and the inductance are bypassed in the AN 200. Only the RC network and the shunt resistor are in the circuit. For remove the RC network you must disconnect the 50Ω Resistor R_z at the rear side of the AN 200.

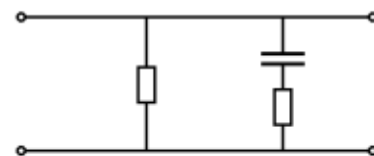

Figure 4

Switch

The switch inside the AN 200 is active and the inductance is bypassed. The switch will open according the setting:

AUTO : 1Hz repetition

MANUAL : Manual release or with ext. Trigger

Interruption : 10ms or 200ms depends on switch position.

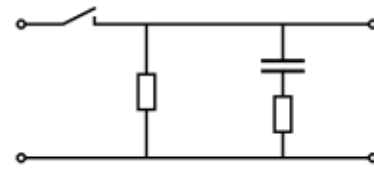

Figure 5

Artificial Network

In the AN 200 the artificial network is active. The switch is bypassed. Please check that the 50Ω Resistor R_z at the rear side of the AN 200 is mounted. Otherwise the Artificial network does not confirm with the standard ISO 7637 part 2

The shunt resistor is switchable between 10Ω and 40Ω. umschaltbar.

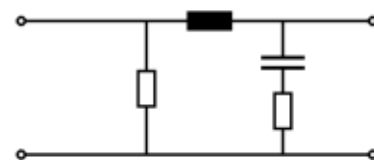

Figure 6

Switch and Artificial Network

This mode is not official. The user get this network, when the switches Switch and Artificial Network are pressed at the same time.

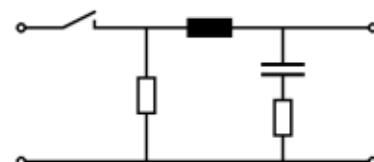

Figure 7

3.2. Electronic switch

The electronic switch disconnects the DUT from battery supply voltage for a specified time in a well specified and reproducible manner.

The electronic switch is in **On status** during **NORMAL** and **SWITCH** operation while **TEST ON** is pushed in.. The red LED indicates **On status**.

In **AUTO** mode the electronic switch is triggered internally with 1Hz repetition rate. In **MANUAL** mode the switch is triggered either by pushing the **MANUAL** button or by remote trigger.

The electronic switch can switch currents up to 25A and is able to withstand voltages up to 1000V.

The electronic switch are electronically protected against overload and can withstand short-circuit conditions. Specific protection requirements of the EUT must be separately assured by the user.

Inrush currents

Inrush currents up to 500A are permitted.

Overvoltage

The switch is protected against over voltages higher than 1000V by internal varistors.

3.3. Shunt resistor

The shunt resistor shall simulate the dc impedance of other connected consumers in the cable tree.

According to ISO/DIN 7637 when measuring transient overvoltage a shunt resistor of 40 Ω is required, whereas when measuring transient overcurrent a shunt resistor of 2 Ω is required. For this purpose an external resistor of 2.5 Ω / 400 W (at 30 V DC) is connected to the safety banana plugs. The external shunt resistor shall be a non-inductive one.

3.4. Artificial network

The artificial network is used to carry out the measurements of conducted emission under constant impedance parameters. According to ISO/DIN 7637 the following substitute diagram is provided.

Parameter of artificial network

Inductance : $L = 5\mu\text{H}$ $R_L < 5\text{m}\Omega$

RC Network : $C_z = 0.1\mu\text{F}$ (250V ac)
 $R_z = 50\Omega$

Source input: Connectors A, B

Output DUT : Connectors P, B

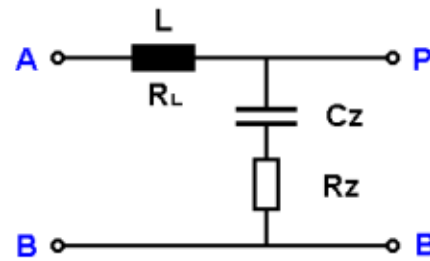

Figure 8

The parallel resistor $R_z = 50\Omega$ is built as a coaxial resistor and is placed on the BNC connector at the rear panel. The impedance characteristic is shown within the following diagram.

The enclosed illustration of a measured curve (impedance characteristic) shows typical impedance values in the frequency range.

Individuelle Einzelaufnahme des Impedanzverlaufs für EM TEST AG (4/1989)

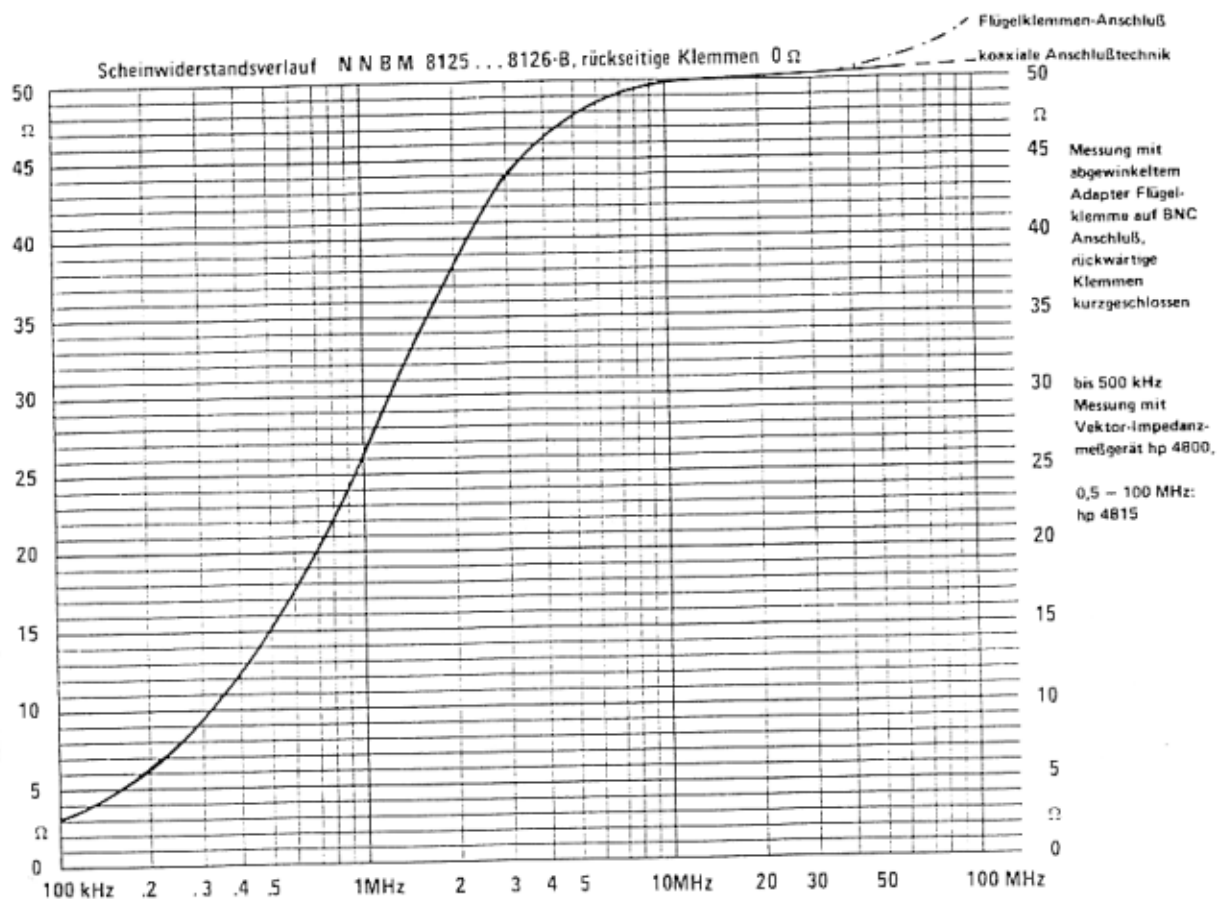

Figure 9 : Impedance of the artificial Network

4. Technical Data

Test supply	AN 200	AN 200B
Voltage range	0-30 VDC	0-60 VDC
Rated current	25 A	50 A
Short circuit protected		
max. inrush current	> 500 A	
Peak voltage capability	1000 V	
Overvoltage protection	by varistors	
Electronic switch		
Switching time (test load L=7 μ H / R=0.6 Ω)	300 - 400 ns	
Switch-off time can be selected	10 ms / 200 ms	
Artificial network		
Impedance according ISO/DIN 7637	5 μ H - 50 Ω	
Inductance	(5 μ H / 5 m Ω)	
Shunt resistor (Rs)		
Internal selectable	40 Ω / 10 Ω	
Option:		
External shunt resistor (Rs = 2 Ω)	2 Ω	
Trigger		
MANUAL	Manual trigger of a single event	
AUTO	Automatic trigger with 1Hz	
EXT	External trigger 0V, BNC	
Mode		
NORMAL	Switch and artificial network are activated	
SWITCH	Only the switch is activated	
ARTIFICIAL NETWORK	Only the network is activated	
Measurement		
Trigger output for CRO	BNC, positive edge + 15 V	
Measuring probe included	BNC, 1 : 100 \pm 2%	
Switch-on indication	LED-display	
Dimensions (L x B x H)	AN 200	AN 200B
	425 x 530 x 180 mm	425 x 530 x 360 mm
	19" 3HE	19" 6HE
Weight	10 Kg	28 kg

5. Calibration / Measuring procedure

5.1. Test load

For measuring the switch-off time the following test load (DUT) is specified in relevant standard references:

Test load => R (total) = $0,6 \Omega$ in series with
 L (total) = $50 \mu\text{H}$ (1 kHz)

Both R and L also include the variations of the cable and the structure. The parallel capacity which cannot be avoided is approx. 50pF . The test must be constructed such that the permanent current can be used at maximum test voltage.

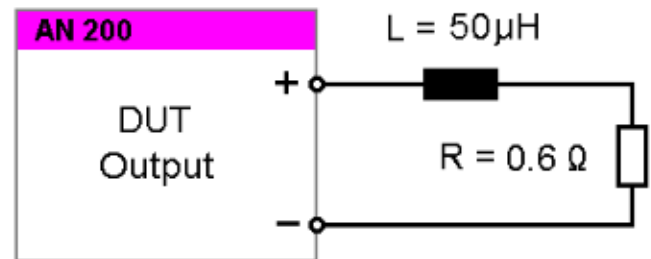

Figure 10 : Testlast

5.2. Test voltage

According to the standards the switch-off times should be determined under varying test voltages. Proposals: for V_a : $U_1 = 13.5\text{V}$ and $U_2 = 27\text{V}$

Consequently constant currents of 22.5A or 45A must be considered. Due to the fact that the AN 200 is only constructed for currents up to 25A , calibration is only carried out with $U_1 = 13.5\text{V}$. The resulting energy consumption at the test load is approx. 300W .

5.3. Switch-off times

The switch-off times are specified as follows, whereas fall time of the switch-off pulse is involved and measured between 10 and 90% of the maximum amplitude:

ISO 7637 (old version ≤ 1992)	$t_f = 200 \dots 400\text{ns}$
ISO 7637 new and DIN 40839 part 1	$t_f = 300\text{ns} \pm 20\%$

5.4. Blockdiagram

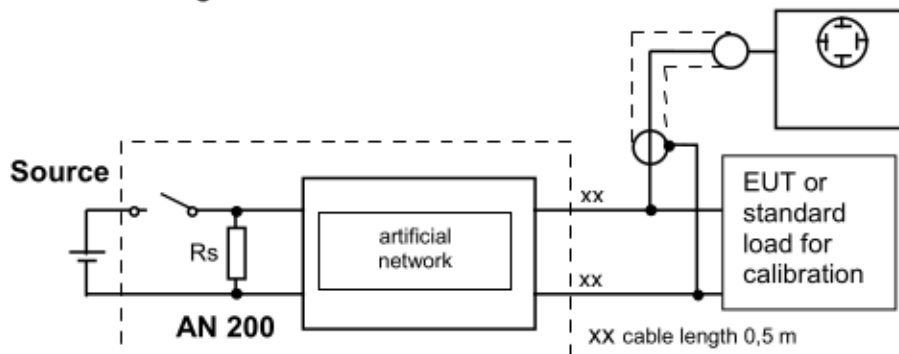

Figure 11 : Blockdiagram test setup

5.5. Measuring results

5.5.1. Voltage drop in dependence of the test load

DUT current		voltage drop (reference value)		Tolerance
1	A	1.8	V	±30%
10	A	3.0	V	±30%
23	A	3.5	V	±30%
45	A (only AN200B 60V50A)	4.5	V	±30%

→ manufacturer values

5.5.2. Measuring results with calibration according to standards

All measuring values indicated as well as the curve illustrated have been recorded with a serial model.

Reference values measured with AN 200

Input Voltage: **17.75 V**
 Output Voltage: **13.50 V**
 Upeak: **- 401 V**
 tf (90% - 10%): **323 ns**

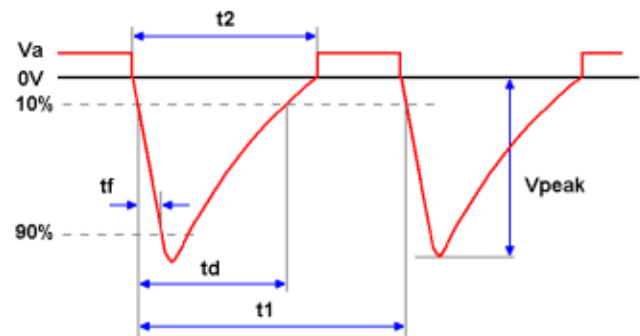

Figure 12 : Pulse parameters

Impedance setting 40Ω	Va output voltage	Vpeak	tf 90% - 10% fall time
Mit Normlast	-13.5V ±10%	400V ±30%	300ns ±20%
Mit Normlast (nur AN200B 60V50A)	-27V ±10%	600V ±30%	300ns ±20%

Example for the switch off impulse

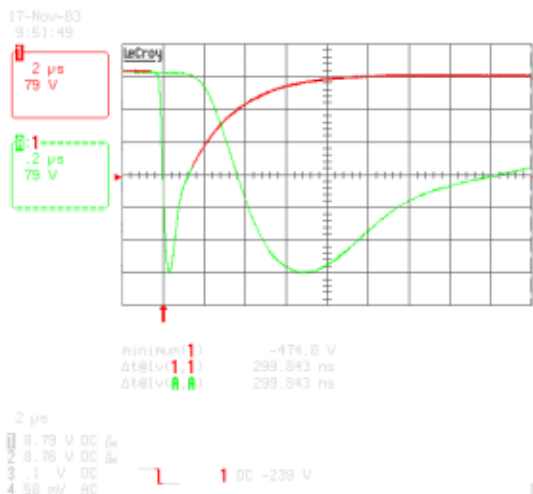

Figure 13 : Test load at 13.5V

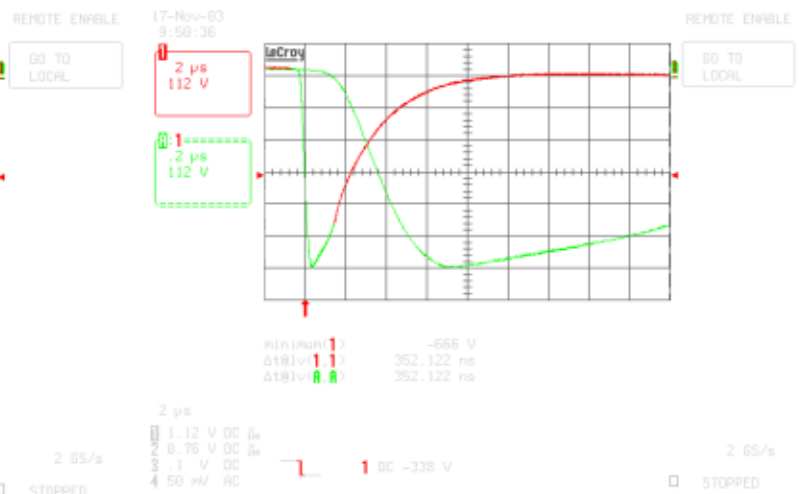

Figure 14 : Test load at 13.5V 27V (AN 200B)

6. Maintenance

6.1. General

The internal switch is absolutely maintenance-free by using a solid state semiconductor .

6.2. Function check

Similar to all measuring and test instruments the correct function of the battery supply switch should be checked from time to time. The check is best carried out according to the following procedure:

- Switch on the power mains supply and connect the DUT battery supply.
- Select **NORMAL** operation;
- Select the **Off time** to 200ms;
- Select the shunt resistor to 10 Ω ;
- Select the **AUTO** trigger mode.

After pushing the **TEST ON** button the LED should now blink at a frequency of 1Hz and the EUT supply is switched off for 200ms each time. This can be checked at the **Monitor CRO** output. For this purpose a storage oscilloscope of at least 20MHz bandwidth is needed.

6.3. Test setup

The test offered by the AN 200 generator is a immunity test on electronic equipments or devices. Therefore it is the responsibility of the user to avoid critical failures and risks to the environment and operator.

Please refer to the safety manual before starting to work with the AN 200

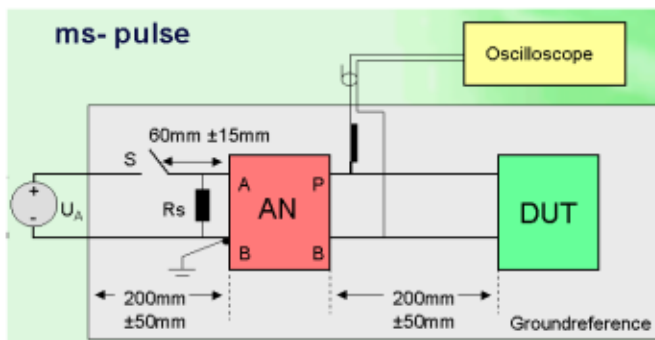

Figure 15 : Setup for pulses in the ms range

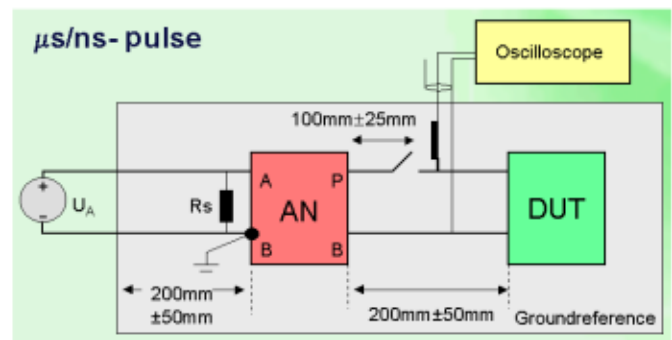

Figure 16 : Setup for pulses in the μ s / ns range

Important

- The artificial network AN shall be connected directly to the ground reference plane.
- All wires between AN and the DUT shall be isolated from the ground plane by 50mm.
- The DUT will be placed on the ground plane as in real installation.
 - directly grounded to the ground plane or
 - 50mm isolated from the ground plane
- The position of the instruments shall be as specified in the standard.

6.4. Safety aspects

National and international recommendations regarding human safety must be followed. When setting up the test national and international regulations regarding human safety have to be guaranteed.

The test offered by the AN 200 generator is a immunity test on electronic equipments or devices. Therefore it is the responsibility of the user to avoid critical failures and risks to the environment and operator.

Long and distributed lines of the EUT are able to radiate a certain energy to their vicinity. Therefore it is also the responsibility of the user to decide whether it is allowed to conduct immunity tests in a given installation.

7. Delivery Groups

7.1. Basic equipment

- Artificial network AN 200 / AN 200B
- Mains cable
- 1 set safety labor cables red / black
- Manual on CD
- Calibration certificate

7.2. Options

- AN 200B Artificial network for 60V 50A



Figure 17 : AN 200B front view



Figure 18 : AN 200B rear view

8. Appendix

8.1. Declaration of CE-Conformity

Manufacturer : **EM TEST AG**
 Address: Sternenhofstr. 15CH 4153 Reinach
 Switzerland

declares, that under its sole responsibility, the product's listed below, including all their options, are in conformity with the applicable CE directives listed below using the relevant section of the following EC standards and other normative documents.

Product's name: Artificial Network
 Model Number(s) AN 200, AN 200B

Low Voltage Directive 73/23/EEC

Standard to which conformity is declared:
 EN 61010-1:1993

Safety

EMC Directive 89/336/EEC

Standard(s) to which conformity is declared:

Emissions: EN 55022:1998 +A1:2000, Class A
 EN 61000-6-4 2001 EN 61000-3-2 A14: 2000

Conducted and radiated.
 Harmonics

Immunity: EN 61000-6-2 2001 EN 61000-4-2:1995 +A1:1998 +A2:2001
 EN 61000-4-3:2002 +A1:2001
 EN 61000-4-6:1996 + A1:2001
 EN 61000-4-4: 1995+A1:2001 +A2:2001
 EN 61000-4-5: 1995+A1:2001
 EN 61000-4-11: 1994+A1:2000

Electrostatic Discharges
 RF Electromagnetic Field
 Conducted RF
 Electrical Fast Transient / Burst
 Surge
 DIPS & Voltage Variations

European representative
 EM TEST GmbH
 Lünenerstr. 211
 D 59174 Kamen
 Tel: 00492307-18042
 Fax: 00492307-17050

Manufacturer
 EM TEST AG
 Sternenhofstr. 15
 CH 4153 Reinach
 Tel: 004161-7179191
 Fax: 004161-7179199



By U. Flor
 General manager
 Place Kamen, Germany
 Date 20. November 2002

H. Kunkel
 Design and Research
 Reinach BL, Switzerland
 20. November 2002

8.2. AN 200 - Overview

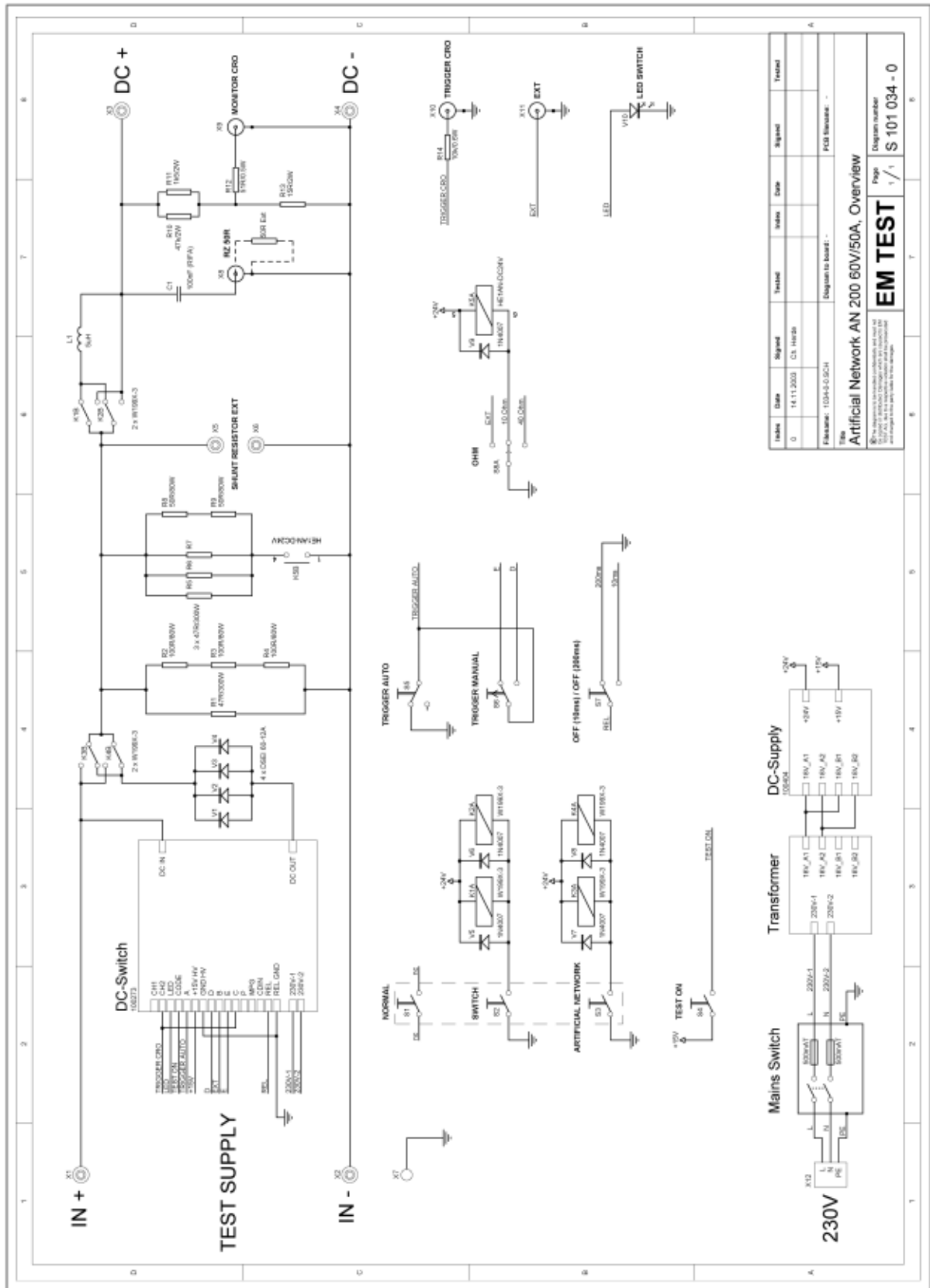

Figure 19 : Overview AN 200 / AN 200B