

**FLUKE®**

# **5500A**

Multi-Product Calibrator

## Operator Manual

## **LIMITED WARRANTY & LIMITATION OF LIABILITY**

Each Fluke product is warranted to be free from defects in material and workmanship under normal use and service. The warranty period is one year and begins on the date of shipment. Parts, product repairs and services are warranted for 90 days. This warranty extends only to the original buyer or end-user customer of a Fluke authorized reseller, and does not apply to fuses, disposable batteries or to any product which, in Fluke's opinion, has been misused, altered, neglected or damaged by accident or abnormal conditions of operation or handling. Fluke warrants that software will operate substantially in accordance with its functional specifications for 90 days and that it has been properly recorded on non-defective media. Fluke does not warrant that software will be error free or operate without interruption.

Fluke authorized resellers shall extend this warranty on new and unused products to end-user customers only but have no authority to extend a greater or different warranty on behalf of Fluke. Warranty support is available if product is purchased through a Fluke authorized sales outlet or Buyer has paid the applicable international price. Fluke reserves the right to invoice Buyer for importation costs of repair/replacement parts when product purchased in one country is submitted for repair in another country.

Fluke's warranty obligation is limited, at Fluke's option, to refund of the purchase price, free of charge repair, or replacement of a defective product which is returned to a Fluke authorized service center within the warranty period.

To obtain warranty service, contact your nearest Fluke authorized service center or send the product, with a description of the difficulty, postage and insurance prepaid (FOB Destination), to the nearest Fluke authorized service center. Fluke assumes no risk for damage in transit. Following warranty repair, the product will be returned to Buyer, transportation prepaid (FOB Destination). If Fluke determines that the failure was caused by misuse, alteration, accident or abnormal condition of operation or handling, Fluke will provide an estimate of repair costs and obtain authorization before commencing the work. Following repair, the product will be returned to the Buyer transportation prepaid and the Buyer will be billed for the repair and return transportation charges (FOB Shipping Point).

**THIS WARRANTY IS BUYER'S SOLE AND EXCLUSIVE REMEDY AND IS IN LIEU OF ALL OTHER WARRANTIES, EXPRESS OR IMPLIED, INCLUDING BUT NOT LIMITED TO ANY IMPLIED WARRANTY OF MERCHANTABILITY OR FITNESS FOR A PARTICULAR PURPOSE. FLUKE SHALL NOT BE LIABLE FOR ANY SPECIAL, INDIRECT, INCIDENTAL OR CONSEQUENTIAL DAMAGES OR LOSSES, INCLUDING LOSS OF DATA, WHETHER ARISING FROM BREACH OF WARRANTY OR BASED ON CONTRACT, TORT, RELIANCE OR ANY OTHER THEORY.**

Since some countries or states do not allow limitation of the term of an implied warranty, or exclusion or limitation of incidental or consequential damages, the limitations and exclusions of this warranty may not apply to every buyer. If any provision of this Warranty is held invalid or unenforceable by a court of competent jurisdiction, such holding will not affect the validity or enforceability of any other provision.

Fluke Corporation  
P.O. Box 9090  
Everett, WA 98206-9090  
U.S.A.

Fluke Europe B.V.  
P.O. Box 1186  
5602 BD Eindhoven  
The Netherlands

## LIMITE DE GARANTIE ET LIMITE DE RESPONSABILITE

La société Fluke garantit l'absence de vices des matériaux et à la fabrication de ce produit dans des conditions normales d'utilisation et d'entretien. La période de garantie est de un an et prend effet à la date d'expédition. Les pièces, les réparations de produit et les services sont garantis pour un période de 90 jours. Cette garantie ne s'applique qu'à l'acheteur d'origine ou à l'utilisateur final s'il est client d'un distributeur agréé par Fluke, et ne s'applique pas aux fusibles, aux batteries/piles interchangeables ni à aucun produit qui, de l'avis de Fluke, a été malmené, modifié, négligé ou endommagé par accident ou soumis à des conditions anormales d'utilisation et de manipulation. Fluke garantit que le logiciel fonctionnera en grande partie conformément à ses spécifications fonctionnelles pour une période de 90 jours et qu'il a été correctement enregistré sur des supports non défectueux. Fluke ne garantit pas que le logiciel ne contient pas d'erreurs ou qu'il fonctionne sans interruption.

Les distributeurs agréés par Fluke appliqueront cette garantie à des produits vendus à leurs clients neufs et qui n'ont pas servi ne sont pas autorisés à appliquer une garantie plus étendue ou différente au nom de Fluke. Le support de garantie est offert si le produit a été acquis par l'intermédiaire d'un point de vente agréé par Fluke ou bien si l'acheteur a payé le prix international applicable. Fluke se réserve le droit de facturer à l'acheteur les frais d'importation des pièces de réparation ou de remplacement si le produit acheté dans un pays a été expédié dans un autre pays pour y être réparé.

L'obligation de garantie de Fluke est limitée, au choix de Fluke, au remboursement du prix d'achat, ou à la réparation/remplacement gratuit d'un produit défectueux retourné dans le délai de garantie à un centre de service agréé par Fluke.

Pour avoir recours au service de la garantie, mettez-vous en rapport avec le centre de service Fluke le plus proche ou envoyez le produit, accompagné d'une description du problème, port et assurance payés (franco lieu de destination), au centre de service agréé par Fluke le plus proche. Fluke dégage toute responsabilité en cas de dégradations survenues au cours du transport. Après la réparation sous garantie, le produit sera retourné à l'acheteur, frais de port payés d'avance (franco lieu de destination). Si Fluke estime que le problème a été causé par un traitement abusif, une modification, un accident ou des conditions de fonctionnement ou de manipulation anormales, Fluke fournira un devis des frais de réparation et ne commencera la réparation qu'après en avoir reçu l'autorisation. Après la réparation, le produit sera retourné à l'acheteur, frais de port payés d'avance, et les frais de réparation et de transport lui seront facturés.

LA PRESENTE GARANTIE EST EXCLUSIVE ET TIENT LIEU DE TOUTES AUTRES GARANTIES, EXPLICITES OU IMPLICITES, Y COMPRIS, MAIS NON EXCLUSIVEMENT, TOUTE GARANTIE IMPLICITE QUANT A L'APTITUDE DU PRODUIT A ETRE COMMERCIALISE OU A ETRE APPLIQUE A UNE FIN OU A UN USAGE DETERMINE. FLUKE NE POURRA ETRE TENU RESPONSABLE D'AUCUN DOMMAGE PARTICULIER, INDIRECT, ACCIDENTEL OU CONSECUTIF, NI D'AUCUNS DEGATS OU PERTES DE DONNEES, QUE CE SOIT A LA SUITE D'UNE INFRACTION AUX OBLIGATIONS DE GARANTIE, SUR UNE BASE CONTRACTUELLE, EXTRA- CONTRACTUELLE OU AUTRE.

Etant donné que certains pays ou états n'admettent pas les limitations d'une condition de garantie implicite, ou l'exclusion ou la limitation de dégâts accidentels ou consécutifs, les limitations et les exclusions de cette garantie pourraient ne pas s'appliquer à chaque acheteur. Si une disposition quelconque de cette garantie est jugée non valide ou inapplicable par un tribunal compétent, une telle décision n'affectera en rien la validité ou le caractère exécutoire de toute autre disposition.

Fluke Corporation  
P.O. Box 9090  
Everett, WA 98206-9090  
USA

Fluke Europe B.V.  
P.O. Box 1186  
5602 B.D. Eindhoven  
Pays-Bas

## **BEFRISTETE GARANTIEBESTIMMUNGEN & HAFTUNGSBESCHRÄNKUNG**

Für jedes Produkt, das Fluke herstellt, leistet Fluke eine Garantie für einwandfreie Materialqualität und fehlerfreie Ausführung unter normalen Betriebs- und Wartungsbedingungen. Der Garantiezeitraum gilt für ein Jahr und beginnt mit dem Lieferdatum. Die Garantiebestimmungen für Ersatzteile, Instandsetzungs- und Wartungsarbeiten gelten für einen Zeitraum von 90 Tagen. Diese Garantie wird ausschließlich dem Ersterwerber bzw. dem Endverbraucher, der das betreffende Produkt von einer von Fluke autorisierten Weiterverkaufsstelle erworben hat, geleistet und erstreckt sich nicht auf Sicherungen, Einwegbatterien oder irgendwelche andere Produkte, die nach dem Ermessen von Fluke unsachgemäß verwendet, verändert, vernachlässigt, durch Unfälle beschädigt oder abnormalen Betriebsbedingungen oder einer unsachgemäßen Handhabung ausgesetzt wurden. Fluke garantiert für einen Zeitraum von 90 Tagen, daß die Software im wesentlichen in Übereinstimmung mit den einschlägigen Funktionsbeschreibungen funktioniert und daß diese Software auf fehlerfreien Datenträgern gespeichert wurde. Fluke übernimmt jedoch keine Garantie dafür, daß die Software fehlerfrei ist und störungsfrei arbeitet.

Von Fluke autorisierte Weiterverkaufsstellen werden diese Garantie ausschließlich für neue und nichtbenutzte, an Endverbraucher verkaufte Produkte leisten, sind jedoch nicht dazu berechtigt, diese Garantie im Namen von Fluke zu verlängern, auszudehnen oder in irgendeiner anderen Weise abzuändern. Der Erwerber hat das Recht aus der Garantie abgeleitete Unterstützungsleistungen in Anspruch zu nehmen, wenn er das Produkt bei einer von Fluke autorisierten Vertriebsstelle gekauft oder den jeweils geltenden internationalen Preis gezahlt hat. Fluke behält sich das Recht vor, dem Erwerber Einfuhrgebühren für Ersatzteile in Rechnung zu stellen, wenn dieser das Produkt in einem anderen Land zur Reparatur anbietet, als das Land, in dem er das Produkt ursprünglich erworben hat.

Flukes Garantieverpflichtung beschränkt sich darauf, daß Fluke nach eigenem Ermessen den Kaufpreis ersetzt oder aber das defekte Produkt unentgeltlich repariert oder austauscht, wenn dieses Produkt innerhalb der Garantiefrist einem von Fluke autorisierten Servicezentrum zur Reparatur übergeben wird.

Um die Garantieleistung in Anspruch zu nehmen, wenden Sie sich bitte an das nächstgelegene und von Fluke autorisierte Servicezentrum oder senden Sie das Produkt mit einer Beschreibung des Problems und unter Vorauszahlung von Fracht- und Versicherungskosten (FOB Bestimmungsort) an das nächstgelegene und von Fluke autorisierte Servicezentrum. Fluke übernimmt keinerlei Haftung für eventuelle Transportschäden. Im Anschluß an die Reparatur wird das Produkt unter Vorauszahlung von Frachtkosten (FOB Bestimmungsort) an den Erwerber zurückgesandt. Wenn Fluke jedoch feststellt, daß der Defekt auf unsachgemäße Handhabung, Veränderungen am Gerät, einen Unfall oder auf anormale Betriebsbedingungen oder unsachgemäße Handhabung zurückzuführen ist, wird Fluke dem Erwerber einen Voranschlag der Reparaturkosten zukommen lassen und erst die Zustimmung des Erwerbers einholen, bevor die Arbeiten in Angriff genommen werden. Nach der Reparatur wird das Produkt unter Vorauszahlung der Frachtkosten an den Erwerber zurückgeschickt und werden dem Erwerber die Reparaturkosten und die Versandkosten (FOB Versandort) in Rechnung gestellt.

DIE VORSTEHENDEN GARANTIEBESTIMMUNGEN SIND DAS EINZIGE UND ALLEINIGE RECHT AUF SCHADENERSATZ DES ERWERBERS UND GELTEN AUSSCHLIESSLICH UND AN STELLE VON ALLEN ANDEREN VERTRAGLICHEN ODER GESETZLICHEN GEWÄHRLEISTUNGSPFLICHTEN, EINSCHLIESSLICH - JEDOCH NICHT DARAUF BESCHRÄNKT - DER GESETZLICHEN GEWÄHRLEISTUNG DER MARKTFÄHIGKEIT, DER GEBRAUCHSEIGNUNG UND DER ZWECKDIENLICHKEIT FÜR EINEN BESTIMMTEN EINSATZ. FLUKE ÜBERNIMMT KEINE HAFTUNG FÜR SPEZIELLE, UNMITTELBARE, MITTELBARE, BEGLEIT- ODER FOLGESCHÄDEN ODER ABER VERLUSTE, EINSCHLIESSLICH DES VERLUSTS VON DATEN, UNABHÄNGIG DAVON, OB SIE AUF VERLETZUNG DER GEWÄHRLEISTUNGSPFLICHT, RECHTMÄSSIGE, UNRECHTMÄSSIGE ODER ANDERE HANDLUNGEN ZURÜCKZUFÜHREN SIND.

Angesichts der Tatsache, daß in einigen Ländern die Begrenzung einer gesetzlichen Gewährleistung sowie der Ausschluß oder die Begrenzung von Begleit- oder Folgeschäden nicht zulässig ist, könnte es sein, daß die obengenannten Einschränkungen und Ausschlüsse nicht für jeden Erwerber gelten. Sollte irgendeine Klausel dieser Garantiebestimmungen von einem zuständigen Gericht für unwirksam oder nicht durchsetzbar befunden werden, so bleiben die Wirksamkeit oder Erzwingbarkeit irgendeiner anderen Klausel dieser Garantiebestimmungen von einem solchen Spruch unberührt.

Fluke Corporation  
Postfach 9090  
Everett, WA 98206-9090  
USA

Fluke Europe B.V.  
Postfach 1186  
5602 B.D. Eindhoven  
Niederlande

## **GARANTÍA LIMITADA Y LIMITACIÓN DE RESPONSABILIDAD**

Se garantiza que cada uno de los productos de Fluke no tiene defectos de material y mano de obra si es objeto de una utilización y un mantenimiento normales. El período de garantía es de un año y comienza a partir de la fecha de envío. Las piezas, reparaciones y mantenimiento del producto están garantizados durante 90 días. Esta garantía se concede exclusivamente al comprador original o al cliente usuario final de un revendedor autorizado por Fluke, y no es de aplicación a fusibles, baterías o pilas desechables o cualquier otro producto que, en opinión de Fluke, haya sido objeto de una mala utilización, alteración, negligencia o daños por accidente o manejo o manipulación anómalos. Fluke garantiza que el software operará sustancialmente de acuerdo con sus especificaciones funcionales durante 90 días y que ha sido grabado correctamente en medios no defectuosos. Fluke no garantiza que el software carezca de errores ni opere sin interrupción.

Los revendedores autorizados por Fluke concederán esta garantía a productos nuevos y sin utilizar suministrados a clientes usuarios finales exclusivamente, pero no tienen autoridad para conceder una garantía diferente o mayor por cuenta de Fluke. Puede utilizar el servicio de garantía si el producto ha sido comprado en una oficina de ventas Fluke autorizada o si el Comprador ha pagado el importe de aplicación internacional. Fluke se reserva el derecho de facturar al Comprador los costes de importación debidos a la reparación o sustitución de piezas cuando el producto comprado en un país es enviado para su reparación a otro país.

La obligación de Fluke en concepto de garantía se limita, a criterio de Fluke, al reembolso del importe de la compra, a la reparación gratis, o a la sustitución de un producto defectuoso que sea devuelto a un centro de servicio Fluke autorizado dentro del período de garantía.

Para obtener servicio en garantía, póngase en contacto con el Servicio Oficial Fluke autorizado más próximo o envíe el producto, con una descripción del problema surgido, a portes y seguros pagados por anticipado (FOB en Destino), al Servicio Oficial Fluke autorizado más próximo. Fluke no asume ningún riesgo por los daños en tránsito. Tras la reparación en concepto de garantía, el producto será devuelto al Comprador, previo pago del transporte (FOB en Destino). Si Fluke decide que la avería ha sido causada por una mala utilización, alteración, accidente o manejo o manipulación anormales, Fluke hará una estimación de los costes de reparación y solicitará autorización antes de comenzar el trabajo. Tras la reparación, el producto será devuelto al Comprador, previo pago del transporte, y se facturarán al Comprador los gastos en concepto de reparación y de transporte para su devolución (FOB en el Punto de envío).

**ESTA GARANTÍA SE CONCEDE A TÍTULO ÚNICO Y EXCLUSIVO DEL COMPRADOR Y SUSTITUYE A TODAS LAS DEMÁS GARANTÍAS, EXPRESAS O IMPLÍCITAS, INCLUYENDO, PERO SIN LIMITARSE A, NINGUNA GARANTÍA IMPLÍCITA DE COMERCIABILIDAD O IDONEIDAD PARA UN FIN O UN USO DETERMINADOS. FLUKE NO SE RESPONSABILIZARÁ DE PÉRDIDAS O DAÑOS ESPECIALES, INDIRECTOS, IMPREVISTOS O CONTINGENTES, INCLUIDA LA PÉRDIDA DE DATOS, YA SEAN PRODUCTO DE VIOLACIÓN DE LA GARANTÍA O YA SEA EN RELACIÓN CON UN CONTRATO, POR RESPONSABILIDAD CIVIL EXTRA CONTRACTUAL, CONFIANZA O EN CUALQUIER OTRA FORMA.**

Dado que algunos países o estados no permiten la limitación del plazo de una garantía implícita, ni la exclusión o limitación de daños imprevistos o contingentes, las limitaciones y exclusiones de esta garantía pueden no ser de aplicación a todos los compradores. Si alguna disposición de esta Garantía es considerada nula o no aplicable por un tribunal de justicia competente, dicha consideración no afectará a la validez o aplicación de las demás disposiciones.

Fluke Corporation  
P.O. Box 9090  
Everett, WA 98206-9090  
ESTADOS UNIDOS

Fluke Europe B.V.  
P.O. Box 1186  
5602 B.D. Eindhoven  
Holanda

## CAUTION

**This is an IEC safety Class 1 product. Before using, the ground wire in the line cord or rear panel binding post must be connected to an earth ground for safety.**

### **Interference Information**

This equipment generates and uses radio frequency energy and if not installed and used in strict accordance with the manufacturer's instructions, may cause interference to radio and television reception. It has been type tested and found to comply with the limits for a Class B computing device in accordance with the specifications of Part 15 of FCC Rules, which are designed to provide reasonable protection against such interference in a residential installation.

Operation is subject to the following two conditions:

- This device may not cause harmful interference.
- This device must accept any interference received, including interference that may cause undesired operation.

There is no guarantee that interference will not occur in a particular installation. If this equipment does cause interference to radio or television reception, which can be determined by turning the equipment off and on, the user is encouraged to try to correct the interference by one of more of the following measures:

- Reorient the receiving antenna
- Relocate the equipment with respect to the receiver
- Move the equipment away from the receiver
- Plug the equipment into a different outlet so that the computer and receiver are on different branch circuits

If necessary, the user should consult the dealer or an experienced radio/television technician for additional suggestions. The user may find the following booklet prepared by the Federal Communications Commission helpful: How to Identify and Resolve Radio-TV Interference Problems. This booklet is available from the U.S. Government Printing Office, Washington, D.C. 20402. Stock No. 004-000-00345-4.

### **Declaration of the Manufacturer or Importer**

We hereby certify that the Fluke Model 5500A is in compliance with BMPT Vfg 243/1991 and is RFI suppressed. The normal operation of some equipment (e.g. signal generators) may be subject to specific restrictions. Please observe the notices in the users manual. The marketing and sales of the equipment was reported to the Central Office for Telecommunication Permits (BZT). The right to retest this equipment to verify compliance with the regulation was given to the BZT.

### **Bescheinigung des Herstellers/Importeurs**

Hiermit wird bescheinigt, daß die Fluke Model 5500A in Übereinstimmung mit den Bestimmungen der BMPT-AmtsblVfg 243/1991 funk-entstört sind. Der vorschriftsmäßige Betrieb mancher Geräte (z.B. Meßsender) kann allerdings gewissen Einschränkungen unterliegen. Beachten Sie deshalb die Hinweise in der Bedienungsanleitung. Dem Bundesamt für Zulassungen in der Telekommunikation wurde das Inverkehrbringen dieses Gerätes angezeigt und die Berechtigung zur Überprüfung der Serie auf Einhaltung der Bestimmungen eingeräumt.

Fluke Corporation

## SAFETY TERMS IN THIS MANUAL

This instrument has been designed and tested in accordance with IEC publication 1010-1 (1992-1), Safety Requirements for Electrical Measuring, Control and Laboratory Equipment, and ANSI/ISA-582.01-1994, and CAN/CSA-C22.2 No. 1010.1-92. This User Manual contains information, warning, and cautions that must be followed to ensure safe operation and to maintain the instrument in a safe condition. Use of this equipment in a manner not specified herein may impair the protection provided by the equipment.

This instrument is designed for IEC 1010-1 Installation Category II use. It is not designed for connection to circuits rated over 4800 VA.

WARNING statements identify conditions or practices that could result in personal injury or loss of life.

CAUTION statements identify conditions or practices that could result in damage to equipment.

### SYMBOLS MARKED ON EQUIPMENT



**WARNING** Risk of electric shock. Refer to the manual (see the Index for references).



**GROUND** Ground terminal to chassis (earth).



**Attention** Refer to the manual (see the Index for references). This symbol indicates that information about usage of a feature is contained in the manual. This symbol appears on the rear panel ground post and by the fuse compartment.

### AC POWER SOURCE

The instrument is intended to operate from an ac power source that will not apply more than 264V ac rms between the supply conductors or between either supply conductor and ground. A protective ground connection by way of the grounding conductor in the power cord is required for safe operation.

### USE THE PROPER FUSE

To avoid fire hazard, for fuse replacement use only the specified unit: 110 or 120 V operation, 2.5 ampere/250 volt time delay; 220 or 240 V operation, 1.25 ampere/250 volt time delay.

### GROUNDING THE INSTRUMENT

The instrument utilizes controlled overvoltage techniques that require the instrument to be grounded whenever normal mode or common mode ac voltages or transient voltages may occur. The enclosure must be grounded through the grounding conductor of the power cord, or through the rear panel ground binding post.

### **USE THE PROPER POWER CORD**

Use only the power cord and connector appropriate for the voltage and plug configuration in your country.

Use only a power cord that is in good condition.

Refer power cord and connector changes to qualified service personnel.

### **DO NOT OPERATE IN EXPLOSIVE ATMOSPHERES**

To avoid explosion, do not operate the instrument in an atmosphere of explosive gas.

### **DO NOT REMOVE COVER DURING OPERATION**

To avoid personal injury or death, do not remove the instrument cover without first removing the power source connected to the rear panel. Do not operate the instrument without the cover properly installed. Normal calibration is accomplished with the cover closed. Access procedures and the warnings for such procedures are contained both in this manual and in the Service Manual. Service procedures are for qualified service personnel only.

### **DO NOT ATTEMPT TO OPERATE IF PROTECTION MAY BE IMPAIRED**

If the instrument appears damaged or operates abnormally, protection may be impaired. Do not attempt to operate the instrument under these conditions. Refer all questions of proper instrument operation to qualified service personnel.



# Table of Contents

Chapter	Contents	Page
<b>1</b>	<b>Introduction and Specifications.....</b>	<b>1-1</b>
1-1.	Introduction.....	1-3
1-2.	How to Contact Fluke.....	1-4
1-3.	Operation Overview.....	1-4
1-4.	Local Operation.....	1-4
1-5.	Remote Operation (RS-232).....	1-4
1-6.	Remote Operation (IEEE-488).....	1-5
1-7.	Where To Go from Here.....	1-6
1-8.	Instruction Manuals.....	1-6
1-9.	5500A Operator Manual.....	1-6
1-10.	5500A Operator Reference Guide.....	1-7
1-11.	5500A Remote Programming Reference Guide.....	1-7
1-12.	5500A Service Manual.....	1-7
1-13.	5725A Amplifier.....	1-7
1-14.	Specifications.....	1-9
1-15.	General Specifications.....	1-10
1-16.	DC Voltage Specifications.....	1-11
1-17.	DC Current Specifications.....	1-12
1-18.	Resistance Specifications.....	1-13
1-19.	AC Voltage (Sine Wave) Specifications.....	1-14
1-20.	AC Current (Sine Wave) Specifications.....	1-17
1-21.	Capacitance Specifications.....	1-19
1-22.	Temperature Calibration (Thermocouple) Specifications.....	1-20
1-23.	Temperature Calibration (RTD) Specifications.....	1-21
1-24.	DC Power Specification Summary.....	1-22
1-25.	AC Power (45 Hz to 65 Hz) Specification Summary, PF=1.....	1-22
1-26.	Power and Dual Output Limit Specifications.....	1-23
1-27.	Phase Specifications.....	1-24
1-28.	Calculating Power Uncertainty.....	1-25

1-29.	Additional Specifications.....	1-26
1-30.	Frequency Specifications.....	1-26
1-31.	Harmonics (2 <sup>nd</sup> to 50 <sup>th</sup> ) Specifications.....	1-26
1-32.	AC Voltage (Sine Wave) Extended Bandwidth Specifications.....	1-27
1-33.	AC Voltage (Non-Sine Wave) Specifications.....	1-28
1-34.	AC Voltage, DC Offset Specifications.....	1-29
1-35.	AC Voltage, Square Wave Characteristics.....	1-29
1-36.	AC Voltage, Triangle Wave Characteristics (typical).....	1-29
1-37.	AC Current (Sine Wave) Extended Bandwidth Specifications.....	1-29
1-38.	AC Current (Non-Sinewave) Specifications.....	1-30
1-39.	AC Current (Non-Sinewave) Specifications (cont).....	1-31
1-40.	AC Current, Square Wave Characteristics (typical).....	1-31
1-41.	AC Current, Triangle Wave Characteristics (typical).....	1-31
<b>2</b>	<b>Preparing for Operation.....</b>	<b>2-1</b>
2-1.	Introduction.....	2-3
2-2.	Unpacking and Inspection.....	2-3
2-3.	Replacing The Fuse.....	2-3
2-4.	Selecting Line Voltage.....	2-4
2-5.	Connecting To Line Power.....	2-4
2-6.	Service Information.....	2-6
2-7.	Placement and Rack Mounting.....	2-7
2-8.	Cooling Considerations.....	2-7
2-9.	Connecting the 5725A Amplifier.....	2-7
<b>3</b>	<b>Features.....</b>	<b>3-1</b>
3-1.	Introduction.....	3-3
3-2.	Front Panel Features.....	3-3
3-3.	Rear Panel Features.....	3-3
3-4.	Softkey Menu Trees.....	3-3
<b>4</b>	<b>Front Panel Operation.....</b>	<b>4-1</b>
4-1.	Introduction.....	4-3
4-2.	Turning on the Calibrator.....	4-3
4-3.	Warming up the Calibrator.....	4-4
4-4.	Using the Softkeys.....	4-4
4-5.	Using the Setup Menu.....	4-4
4-6.	Using the Instrument Setup Menu.....	4-5
4-7.	Selecting an External Amplifier.....	4-5
4-8.	Utility Functions Menu.....	4-6
4-9.	Using the Format EEPROM Menu.....	4-6
4-10.	Resetting the Calibrator.....	4-7
4-11.	Zeroing the Calibrator.....	4-7
4-12.	Using the Operate and Standby Modes.....	4-8
4-13.	Connecting the Calibrator to a UUT.....	4-9
4-14.	Recommended Cable and Connector Types.....	4-9
4-15.	When to Use EARTH.....	4-10
4-16.	Four-Wire versus Two-Wire Connections.....	4-10
4-17.	Cable Connection Instructions.....	4-11

4-18.	Rms Versus Peak-to-Peak Waveforms .....	4-16
4-19.	Auto Range Versus Locked Range .....	4-17
4-20.	Setting the Output .....	4-17
4-21.	Setting DC Voltage Output .....	4-18
4-22.	Setting AC Voltage Output .....	4-19
4-23.	Setting DC Current Output .....	4-21
4-24.	Setting AC Current Output .....	4-22
4-25.	Setting DC Power Output .....	4-24
4-26.	Setting AC Power Output .....	4-25
4-27.	Setting a Dual DC Voltage Output .....	4-28
4-28.	Setting a Dual AC Voltage Output .....	4-30
4-29.	Setting Resistance Output .....	4-32
4-30.	Setting Capacitance Output .....	4-33
4-31.	Setting Temperature Simulation (Thermocouple) .....	4-35
4-32.	Setting Temperature Simulation (RTD) .....	4-37
4-33.	Measuring Thermocouple Temperatures .....	4-39
4-34.	Waveform Types .....	4-40
4-35.	Sinewave .....	4-41
4-36.	Trianglewave .....	4-41
4-37.	Squarewave .....	4-41
4-38.	Truncated Sinewave .....	4-42
4-39.	Setting Harmonics .....	4-42
4-40.	Adjusting the Phase .....	4-43
4-41.	Entering a Phase Angle .....	4-44
4-42.	Entering a Power Factor .....	4-45
4-43.	Entering a DC Offset .....	4-46
4-44.	Using the 5725A Amplifier .....	4-47
4-45.	5725A Amplifier Output .....	4-48
4-46.	Editing and Error Output Settings .....	4-49
4-47.	Editing the Output Setting .....	4-49
4-48.	Displaying the Output Error .....	4-50
4-49.	Using Multiply and Divide .....	4-50
4-50.	Setting Output Limits .....	4-50
4-51.	Setting Voltage and Current Limits .....	4-51
4-52.	Sample Applications .....	4-52
4-53.	Calibrating an 80 Series Handheld Multimeter .....	4-52
4-54.	Cables .....	4-52
4-55.	EARTH Connection .....	4-52
4-56.	Testing the Meter .....	4-53
4-57.	Calibrating the Meter .....	4-57
4-58.	Testing a Model 41 Power Harmonics Analyzer .....	4-58
4-59.	Testing Watts, VA, VAR Performance .....	4-58
4-60.	Testing Harmonics Volts Performance .....	4-60
4-61.	Testing Harmonics Amps Performance .....	4-61
4-62.	Calibrating a Fluke 51 Thermometer .....	4-61
4-63.	Testing the Thermometer .....	4-62
4-64.	Calibrating the Thermometer .....	4-63

**5 Remote Operation ..... 5-1**

5-1.	Introduction .....	5-4
------	--------------------	-----

5-2.	Setting up the IEEE-488 Port for Remote Control .....	5-4
5-3.	IEEE-488 Port Setup Procedure .....	5-7
5-4.	Testing the IEEE-488 Port.....	5-8
5-5.	Setting up the RS-232 Host Port for Remote Control.....	5-10
5-6.	RS-232 Host Port Setup Procedure .....	5-10
5-7.	Testing the RS-232 Host Port.....	5-12
5-8.	Testing RS-232 Host Port Operation using a Terminal .....	5-12
5-9.	Testing RS-232 Host Port Operation using Visual Basic .....	5-14
5-10.	Setting up the RS-232 UUT Port for Remote Control.....	5-15
5-11.	RS-232 UUT Port Setup Procedure.....	5-15
5-12.	Testing the RS-232 UUT Port via RS-232 Host Port.....	5-17
5-13.	Testing RS-232 UUT Port Operation via a Terminal .....	5-17
5-14.	Testing RS-232 UUT Port Operation using Visual Basic.....	5-18
5-15.	Testing the RS-232 UUT Port via IEEE-488 Port.....	5-19
5-16.	Changing between Remote and Local Operation .....	5-21
5-17.	Local State.....	5-21
5-18.	Local with Lockout State.....	5-21
5-19.	Remote State.....	5-21
5-20.	Remote with Lockout State .....	5-21
5-21.	RS-232 Interface Overview .....	5-22
5-22.	IEEE-488 Interface Overview.....	5-23
5-23.	Using Commands.....	5-25
5-24.	Types of Commands.....	5-25
5-25.	Device-Dependent Commands.....	5-25
5-26.	Common Commands.....	5-26
5-27.	Query Commands.....	5-26
5-28.	Interface Messages (IEEE-488) .....	5-26
5-29.	Compound Commands.....	5-28
5-30.	Coupled Commands .....	5-28
5-31.	Overlapped Commands.....	5-29
5-32.	Sequential Commands.....	5-29
5-33.	Commands that Require the Calibration Switch to be Enabled ...	5-29
5-34.	Commands for RS-232 Only.....	5-29
5-35.	Commands for IEEE-488 Only.....	5-30
5-36.	Command Syntax .....	5-31
5-37.	Parameter Syntax Rules .....	5-31
5-38.	Extra Space or Tab Characters .....	5-32
5-39.	Terminators .....	5-33
5-40.	Incoming Character Processing.....	5-33
5-41.	Response Message Syntax .....	5-34
5-42.	Checking 5500A Status .....	5-35
5-43.	Serial Poll Status Byte (STB).....	5-35
5-44.	Service Request (SRQ) Line .....	5-37
5-45.	Service Request Enable Register (SRE).....	5-37
5-46.	Programming the STB and SRE .....	5-38
5-47.	Event Status Register (ESR).....	5-38
5-48.	Event Status Enable (ESE) Register .....	5-38
5-49.	Bit Assignments for the ESR and ESE.....	5-38
5-50.	Programming the ESR and ESE.....	5-39
5-51.	Instrument Status Register (ISR).....	5-40
5-52.	Instrument Status Change Registers.....	5-40

5-53.	Instrument Status Change Enable Registers.....	5-40
5-54.	Bit Assignments for the ISR, ISCR, and ISCE .....	5-40
5-55.	Programming the ISR, ISCR, and ISCE .....	5-42
5-56.	Output Queue .....	5-42
5-57.	Error Queue .....	5-43
5-58.	Remote Program Examples.....	5-43
5-59.	Guidelines for Programming the Calibrator .....	5-43
5-60.	Writing an SRQ and Error Handler .....	5-44
5-61.	Verifying a Meter on the IEEE-488 Bus .....	5-45
5-62.	Verifying a Meter on the RS-232 UUT Serial Port .....	5-45
5-63.	Using *OPC?, *OPC, and *WAI .....	5-45
5-64.	Taking a Thermocouple Measurement .....	5-46
5-65.	Using the RS-232 UUT Port to Control an instrument .....	5-46
5-66.	Input Buffer Operation .....	5-47
<b>6</b>	<b>Remote Commands.....</b>	<b>6-1</b>
6-1.	Introduction.....	6-3
6-2.	Command Summary by Function .....	6-3
6-3.	Summary of Commands and Queries .....	6-8
<b>7</b>	<b>Maintenance.....</b>	<b>7-1</b>
7-1.	Introduction.....	7-3
7-2.	Replacing the Line Fuse .....	7-3
7-3.	Cleaning the Air Filter .....	7-4
7-4.	General Cleaning .....	7-6
7-5.	Performing a Calibration Check .....	7-6
7-6.	Performance Tests .....	7-7
7-7.	DC Voltage Amplitude Accuracy (NORMAL) .....	7-7
7-8.	DC Voltage Amplitude Accuracy (AUX).....	7-8
7-9.	DC Current Amplitude Accuracy.....	7-9
7-10.	Resistance Accuracy .....	7-10
7-11.	Resistance DC Offset Measurement.....	7-11
7-12.	AC Voltage Amplitude Accuracy (NORMAL) .....	7-12
7-13.	AC Voltage Amplitude Accuracy (AUX).....	7-13
7-14.	AC Current Amplitude Accuracy.....	7-14
7-15.	Capacitance Accuracy.....	7-16
7-16.	Thermocouple Measurement Accuracy .....	7-17
7-17.	Thermocouple Sourcing Accuracy.....	7-17
7-18.	Thermocouple Measuring Accuracy .....	7-17
7-19.	DC Power Amplitude Accuracy (NORMAL).....	7-18
7-20.	DC Power Amplitude Accuracy (AUX) .....	7-18
7-21.	AC Power Amplitude Accuracy (High Voltage) .....	7-19
7-22.	AC Power Amplitude Accuracy (High Current).....	7-19
7-23.	AC Power Amplitude Accuracy (High Power).....	7-20
7-24.	Phase and Frequency Accuracy .....	7-21
7-25.	AC Voltage Amplitude Accuracy, Squarewave (NORMAL).....	7-22
7-26.	AC Voltage Amplitude Accuracy, Squarewave (AUX) .....	7-23
7-27.	AC Voltage Harmonic Amplitude Accuracy (NORMAL) .....	7-24
7-28.	AC Voltage Harmonic Amplitude Accuracy (AUX).....	7-25
7-29.	DC Voltage Offset Accuracy .....	7-25

7-30.	AC Voltage Accuracy with a DC Offset.....	7-26
7-31.	Non-Operator Fuse Replacement.....	7-26
<b>8</b>	<b>Oscilloscope Calibration Options.....</b>	<b>8-1</b>
	<b>5500A-SC600 Option .....</b>	<b>8-3</b>
8-1.	Introduction.....	8-5
8-2.	SC600 Option Specifications.....	8-5
8-3.	Volt Specifications .....	8-6
8-4.	Edge Specifications .....	8-7
8-5.	Leveled Sine Wave Specifications .....	8-8
8-6.	Time Marker Specifications .....	8-9
8-7.	Wave Generator Specifications .....	8-9
8-8.	Pulse Generator Specifications.....	8-10
8-9.	Trigger Signal Specifications (Pulse Function).....	8-11
8-10.	Trigger Signal Specifications (Time Marker Function) .....	8-11
8-11.	Trigger Signal Specifications (Edge Function) .....	8-11
8-12.	Trigger Signal Specifications (Square Wave Voltage Function) .....	8-11
8-13.	Trigger Signal Specifications .....	8-11
8-14.	Oscilloscope Input Resistance Measurement Specifications.....	8-12
8-15.	Oscilloscope Input Capacitance Measurement Specifications .....	8-12
8-16.	Overload Measurement Specifications .....	8-12
8-17.	Oscilloscope Connections.....	8-13
8-18.	Starting the SC600 Option.....	8-13
8-19.	The Output Signal .....	8-14
8-20.	Adjusting the Output Signal .....	8-14
8-21.	Keying in a Value .....	8-14
8-22.	Adjusting Values with the Rotary Knob .....	8-15
8-23.	Using <b>MULT</b> and <b>DIV</b> .....	8-15
8-24.	Resetting the SC600 Option .....	8-15
8-25.	Calibrating the Voltage Amplitude on an Oscilloscope.....	8-16
8-26.	The VOLT Function .....	8-16
8-27.	The V/DIV Menu .....	8-17
8-28.	Shortcuts for Setting the Voltage Amplitude .....	8-17
8-29.	Oscilloscope Amplitude Calibration Procedure .....	8-18
8-30.	Calibrating the Pulse and Frequency Response on an Oscilloscope.....	8-19
8-31.	The Edge Function .....	8-19
8-32.	Oscilloscope Pulse Response Calibration Procedure .....	8-20
8-33.	Pulse Response Calibration Using a Tunnel Diode Pulser.....	8-21
8-34.	The Leveled Sine Wave Function .....	8-21
8-35.	Shortcuts for Setting the Frequency and Voltage.....	8-22
8-36.	The MORE OPTIONS Menu .....	8-23
8-37.	Sweeping Through a Frequency Range.....	8-24
8-38.	Oscilloscope Frequency Response Calibration Procedure .....	8-24
8-39.	Calibrating the Time Base of an Oscilloscope.....	8-26
8-40.	The Time Marker Function .....	8-26
8-41.	Time Base Marker Calibration Procedure for an Oscilloscope .....	8-27
8-42.	Testing the Trigger.....	8-28
8-43.	Testing Video Triggers .....	8-30
8-44.	Verifying Pulse Capture.....	8-31

8-45.	Measuring Input Resistance and Capacitance.....	8-32
8-46.	Input Impedance Measurement .....	8-32
8-47.	Input Capacitance Measurement .....	8-33
8-48.	Testing Overload Protection .....	8-33
8-49.	Remote Commands and Queries.....	8-34
8-50.	General Commands .....	8-35
8-51.	Edge Function Commands .....	8-38
8-52.	Marker Function Commands .....	8-38
8-53.	Video Function Commands.....	8-38
8-54.	Overload Function Commands.....	8-39
8-55.	Impedance/Capacitance Function Commands.....	8-40
8-56.	Verification Tables .....	8-41
8-57.	DC Voltage Verification.....	8-41
8-58.	AC Voltage Amplitude Verification.....	8-42
8-59.	AC Voltage Frequency Verification.....	8-42
8-60.	Wave Generator Amplitude Verification: 1 M $\Omega$ Output Impedance.....	8-43
8-61.	Wave Generator Amplitude Verification: 50 $\Omega$ Output Impedance..	8-44
8-62.	Leveled Sinewave Verification: Amplitude .....	8-45
8-63.	Leveled Sinewave Verification: Frequency .....	8-45
8-64.	Leveled Sinewave Verification: Harmonics.....	8-46
8-65.	Leveled Sinewave Verification: Flatness .....	8-47
8-66.	Edge Verification: Amplitude .....	8-53
8-67.	Edge Verification: Frequency.....	8-53
8-68.	Edge Verification: Duty Cycle .....	8-53
8-69.	Edge Verification: Rise Time .....	8-54
8-70.	Tunnel Diode Pulser Verification.....	8-54
8-71.	Marker Generator Verification .....	8-55
8-72.	Pulse Generator Verification: Period.....	8-55
8-73.	Pulse Generator Verification: Pulse Width .....	8-55
8-74.	Input Impedance Verification: Resistance.....	8-56
8-75.	Input Impedance Verification: Capacitance .....	8-56
<b>5500A-SC300 Option .....</b>		<b>8-57</b>
8-76.	Introduction.....	8-59
8-77.	Oscilloscope Calibration Option Specifications .....	8-60
8-78.	Volt Function Specifications .....	8-60
8-79.	Edge Function Specifications .....	8-61
8-80.	Leveled Sine Wave Function Specifications .....	8-62
8-81.	Time Marker Function Specifications .....	8-63
8-82.	Wave Generator Specifications .....	8-63
8-83.	Trigger Signal Specifications for the Time Marker Function .....	8-64
8-84.	Trigger Signal Specifications for the Edge Function .....	8-64
8-85.	Oscilloscope Connections.....	8-65
8-86.	Starting the Oscilloscope Calibration Option .....	8-66
8-87.	The Output Signal .....	8-66
8-88.	Adjusting the Output Signal .....	8-67
8-89.	Keying in a Value .....	8-67
8-90.	Adjusting Values with the Rotary Knob .....	8-67
8-91.	Using $\boxed{\text{MULT}}$ and $\boxed{\text{DIV}}$ .....	8-68

8-92.	Resetting the Oscilloscope Option .....	8-68
8-93.	Calibrating the Voltage Amplitude on an Oscilloscope.....	8-69
8-94.	The Volt Function .....	8-69
8-95.	The V/DIV Menu .....	8-70
8-96.	Shortcuts for Setting the Voltage Amplitude .....	8-70
8-97.	Amplitude Calibration Procedure for an Oscilloscope.....	8-71
8-98.	Calibrating the Pulse and Frequency Response on an Oscilloscope.....	8-72
8-99.	The Edge Function .....	8-72
8-100.	Pulse Response Calibration Procedure for an Oscilloscope.....	8-73
8-101.	The Leveled Sine Wave Function .....	8-74
8-102.	Shortcuts for Setting the Frequency and Voltage.....	8-74
8-103.	The MORE OPTIONS Menu .....	8-75
8-104.	Sweeping through a Frequency Range .....	8-77
8-105.	Frequency Response Calibration Procedure for an Oscilloscope.....	8-78
8-106.	Calibrating the Time Base of an Oscilloscope.....	8-80
8-107.	The Time Marker Function .....	8-80
8-108.	Time Base Marker Calibration Procedure for an Oscilloscope .....	8-81
8-109.	Testing the Trigger.....	8-82
8-110.	Summary of Commands and Queries .....	8-83
8-111.	Verification Tables .....	8-86
8-112.	Voltage Function Verification: AC Voltage into a 1 M $\Omega$ Load.....	8-86
8-113.	Voltage Function Verification: AC Voltage into a 50 $\Omega$ Load .....	8-87
8-114.	Voltage Function Verification: DC Voltage into a 50 $\Omega$ Load .....	8-88
8-115.	Voltage Function Verification: DC Voltage into a 1 M $\Omega$ Load.....	8-89
8-116.	Edge Function Verification .....	8-90
8-117.	Wave Generator Function Verification: 1 M $\Omega$ Load .....	8-90
8-118.	Wave Generator Function Verification: 50 $\Omega$ Load.....	8-91
8-119.	Leveled Sinewave Function Verification: Amplitude .....	8-91
8-120.	Leveled Sinewave Function Verification: Flatness .....	8-92
8-121.	Leveled Sinewave Function Verification: Frequency .....	8-95
8-122.	Marker Generator Function Verification.....	8-96

**9 Accessories .....** **9-1**

9-1.	Introduction.....	9-3
9-2.	Rack Mount Kit .....	9-4
9-3.	IEEE-488 Interface Cables .....	9-4
9-4.	RS-232 Null-Modem Cables .....	9-4
9-5.	RS-232 Modem Cables.....	9-4
9-6.	5500A/LEADS .....	9-4
9-7.	5725A Amplifier Accessory .....	9-4

**Index**



# List of Tables

<b>Table</b>		<b>Page</b>
2-1.	Standard Equipment .....	2-3
2-2.	Line Power Cord Types Available from Fluke .....	2-6
3-1.	Front Panel Features .....	3-4
3-2.	Rear Panel Features .....	3-10
3-3.	Factory Default Settings for the SETUP Menus .....	3-22
4-1.	Factory Defaults for SETUP .....	4-7
4-2.	UUT Connections.....	4-11
4-3.	Keys That Exit Error Mode.....	4-49
4-4.	Watts Performance, Text Screen.....	4-59
4-5.	Harmonics Performance for Volts, Harmonics Screen .....	4-60
4-6.	Harmonics Performance for AMPS, Harmonics screen.....	4-61
4-7.	Thermocouple Performance .....	4-63
5-2.	RS-232 Interface Wiring.....	5-22
5-3.	RS-232 Emulation of IEEE-488 Messages .....	5-24
5-4.	Interface Messages that the 5500A Accepts.....	5-28
5-5.	Interface Messages that the 5500A Sends.....	5-29
5-6.	Commands for RS-232 Only.....	5-31
5-7.	Commands for IEEE-488 Only .....	5-31
5-8.	Units Accepted in Parameters and Used in Responses .....	5-32
5-9.	Terminator Characters.....	5-34
5-10.	Response Data Types .....	5-35
5-11.	Status Register Summary .....	5-36
6-1.	Command Summary by Function .....	6-3
7-1.	Replacement Fuses.....	7-3
7-2.	Required Equipment for Checking Calibration.....	7-6
7-3.	Non-Operator Fuse Replacement Locations .....	7-26
9-1.	Options and Accessories .....	9-3



# List of Figures

Figure	Page
1-1. 5500A Multi-Product Calibrator .....	1-3
1-2. RS-232 Remote Connections .....	1-5
1-3. 5725A Amplifier .....	1-8
2-1. Accessing the Fuse and Selecting Line Voltage .....	2-5
2-2. Line Power Cord Types Available from Fluke .....	2-6
3-1. Front Panel View.....	3-4
3-2. Rear Panel View.....	3-10
3-3. SETUP Softkey Menu Tree .....	3-12
3-4. SETUP Softkey Menu Displays.....	3-13
3-5. MEAS TC Softkey Menu Tree.....	3-22
3-6. MEAS TC Softkey Menu Displays.....	3-23
4-1. UUT Connection: Resistance (Four-Wire Compensation).....	4-12
4-2. UUT Connection: Resistance (Two-Wire Compensation).....	4-12
4-3. UUT Connection: Resistance (Compensation Off).....	4-13
4-4. UUT Connection: Capacitance (Four-Wire Compensation).....	4-13
4-5. UUT Connection: Capacitance (Two-Wire Compensation) .....	4-14
4-6. UUT Connection: Capacitance (Compensation Off) .....	4-14
4-7. UUT Connection: DC Voltage/AC Voltage.....	4-15
4-9. UUT Connection: Temperature (RTD).....	4-15
4-10. UUT Connection: Temperature (Thermocouple).....	4-16
4-11. Sinewave .....	4-41
4-12. Trianglewave.....	4-41
4-13. Squarewave and Duty Cycle .....	4-42
4-14. Truncated Sinewave .....	4-42
4-15. Cable Connections for Testing an 80 Series General Functions .....	4-53
4-16. Cable Connections for Testing an 80 Series Current Function .....	4-55
4-17. Cable Connections for Testing an 80 Series High Amps Function.....	4-57
4-18. Cable Connections for Testing a 40 Series Watts Function .....	4-59
4-19. Cable Connections for Testing a 50 Series Thermometer.....	4-62
5-1. Typical IEEE-488 Remote Control Connections .....	5-5
5-2. Typical RS-232 Remote Control Connections.....	5-6
5-3. Typical IEEE-488 Port Connections.....	5-8
5-4. Typical PC COM Port Connections .....	5-12

5-5.	Typical RS-232 UUT Port via RS-232 Host Port Connections .....	5-17
5-6.	Typical RS-232 UUT Port via IEEE-488 Port Connections .....	5-19
5-7.	IEEE-488 Remote Message Coding.....	5-25
5-8.	Status Register Overview .....	5-37
5-9.	Status Byte and SRE Bit Definitions.....	5-38
5-11.	Bit Assignments for the ISR, ISCEs and ISCRs .....	5-42
7-1.	Accessing the Fuse .....	7-4
7-2.	Accessing the Air Filter.....	7-5

# Chapter 1

## Introduction and Specifications

	<b>Contents</b>	<b>Page</b>
1-1.	Introduction.....	1-3
1-2.	How to Contact Fluke.....	1-4
1-3.	Operation Overview.....	1-4
1-4.	Local Operation.....	1-4
1-5.	Remote Operation (RS-232).....	1-4
1-6.	Remote Operation (IEEE-488).....	1-5
1-7.	Where To Go from Here.....	1-6
1-8.	Instruction Manuals.....	1-6
1-9.	5500A Operator Manual.....	1-6
1-10.	5500A Operator Reference Guide.....	1-7
1-11.	5500A Remote Programming Reference Guide.....	1-7
1-12.	5500A Service Manual.....	1-7
1-13.	5725A Amplifier.....	1-7
1-14.	Specifications.....	1-9
1-15.	General Specifications.....	1-10
1-16.	DC Voltage Specifications.....	1-11
1-17.	DC Current Specifications.....	1-12
1-18.	Resistance Specifications.....	1-13
1-19.	AC Voltage (Sine Wave) Specifications.....	1-14
1-20.	AC Current (Sine Wave) Specifications.....	1-17
1-21.	Capacitance Specifications.....	1-19
1-22.	Temperature Calibration (Thermocouple) Specifications.....	1-20
1-23.	Temperature Calibration (RTD) Specifications.....	1-21
1-24.	DC Power Specification Summary.....	1-22
1-25.	AC Power (45 Hz to 65 Hz) Specification Summary, PF=1.....	1-22
1-26.	Power and Dual Output Limit Specifications.....	1-23
1-27.	Phase Specifications.....	1-24
1-28.	Calculating Power Uncertainty.....	1-25
1-29.	Additional Specifications.....	1-26
1-30.	Frequency Specifications.....	1-26
1-31.	Harmonics (2 <sup>nd</sup> to 50 <sup>th</sup> ) Specifications.....	1-26
1-32.	AC Voltage (Sine Wave) Extended Bandwidth Specifications.....	1-27
1-33.	AC Voltage (Non-Sine Wave) Specifications.....	1-28
1-34.	AC Voltage, DC Offset Specifications.....	1-29
1-35.	AC Voltage, Square Wave Characteristics.....	1-29

1-36.	AC Voltage, Triangle Wave Characteristics (typical).....	1-29
1-37.	AC Current (Sine Wave) Extended Bandwidth Specifications .....	1-29
1-38.	AC Current (Non-Sinewave) Specifications .....	1-30
1-39.	AC Current (Non-Sinewave) Specifications (cont).....	1-31
1-40.	AC Current, Square Wave Characteristics (typical).....	1-31
1-41.	AC Current, Triangle Wave Characteristics (typical) .....	1-31

## 1-1. Introduction

The Fluke Model 5500A Multi-Product Calibrator (Figure 1-1) is a precise instrument that calibrates a wide variety of electrical measuring instruments. With the 5500A Calibrator, you can calibrate precision multimeters that measure ac or dc voltage, ac or dc current, ac or dc power, resistance, capacitance, and temperature. With the Oscilloscope Calibration option, you can use the 5500A Calibrator to calibrate analog and digital oscilloscopes. Specifications are provided in this chapter (specifications for the Oscilloscope Calibration option are provided in Chapter 8).

### Warning

**If the 5500A Calibrator is operated in any way not specified by this manual or other documentation provided by Fluke, the protection provided by the Calibrator may be impaired.**

The 5500A Calibrator is a fully programmable precision source of the following:

- DC voltage from 0 V to  $\pm 1020$  V.
- AC voltage from 1 mV to 1020 V, with output from 10 Hz to 500 kHz.
- AC current from 0.01  $\mu$ A to 11.0 A, with output from 10 Hz to 10 kHz.
- DC current from 0 to  $\pm 11.0$  A.
- Resistance values from a short circuit to 330 M $\Omega$ .
- Capacitance values from 330 pF to 1100  $\mu$ F.
- Simulated output for three types of Resistance Temperature Detectors (RTDs).
- Simulated output for nine types of thermocouples.

Features of the 5500A Calibrator include the following:

- Automatic meter error calculation.
- **MULT**  $\times$  and **DIV**  $\div$  keys that change the output value to pre-determined cardinal values for various functions.
- Programmable entry limits that prevent invalid amounts from being entered.

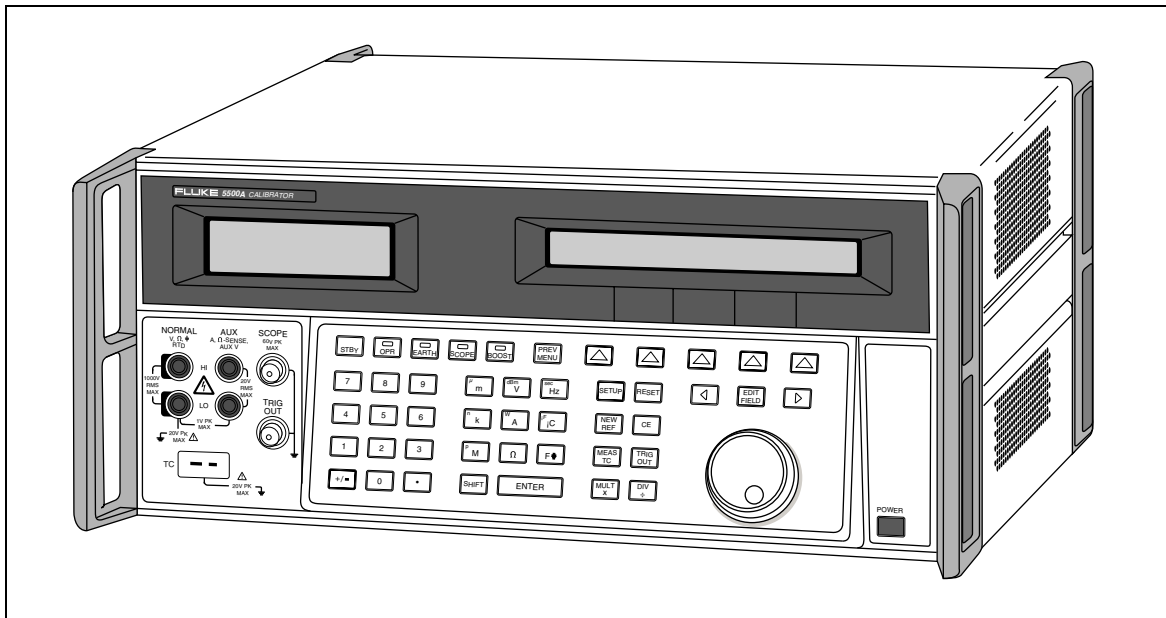

Figure 1-1. 5500A Multi-Product Calibrator

F1-01.eps

- Simultaneous output of voltage and current, up to 11 kW.
- Simultaneous output of two voltages.
- Extended bandwidth mode outputs multiple waveforms down to 0.01 Hz, and sine waves to 2 MHz.
- Variable phase signal output.
- Standard IEEE-488 (GPIB) interface, complying with ANSI/IEEE Standards 488.1-1987 and 488.2-1987.
- EIA Standard RS-232-C serial data interface for printing, displaying, or transferring internally stored calibration constants, and for remote control of the 5500A.
- Pass-through RS-232-C serial data interface for communicating with the Unit Under Test (UUT).
- Extensive automatic internal self testing and diagnostics of analog and digital functions.

## **1-2. How to Contact Fluke**

To contact Fluke, call one of the following telephone numbers:

USA: 1-888-99-FLUKE (1-888-993-5853)

Canada: 1-800-36-FLUKE (1-800-363-5853)

Europe: +31 402-675-200

Japan: +81-3-3434-0181

Singapore: +65-738-5655

Anywhere in the world: +1-425-446-5500

Or, visit Fluke's Web site at [www.fluke.com](http://www.fluke.com).

To register your product, visit [register.fluke.com](http://register.fluke.com).

## **1-3. Operation Overview**

The 5500A Calibrator may be operated at the front panel in the local mode, or remotely using RS-232 or IEEE-488 ports. For remote operations, several software options are available to integrate 5500A operation into a wide variety of calibration requirements.

### **1-4. Local Operation**

Typical local operations include front panel connections to the Unit Under Test (UUT), and then manual keystroke entries at the front panel to place the calibrator in the desired output mode. The front panel layout facilitates hand movements from left to right, and multiply and divide keys make it easy to step up or down at the press of a single key. You can also review 5500A Calibrator specifications at the push of a button [available, July, 1995]. The backlit liquid crystal display is easy to read from many different viewing angles and lighting conditions, and the large, easy-to-read keys are color-coded and provide tactile feedback when they are pressed.

### **1-5. Remote Operation (RS-232)**

There are two rear-panel serial data RS-232 ports: SERIAL 1 FROM HOST, and SERIAL 2 TO UUT (Figure 1-2). Each port is dedicated to serial data communications for operating and controlling the 5500A during calibration procedures. For complete information on remote operations, see Chapter 5.



The SERIAL 1 FROM HOST serial data port connects a host terminal or personal computer to the 5500A. You have several choices for sending commands to the 5500A: you can enter commands from a terminal (for example, using the Terminal accessory from Windows using a PC), you can write your own programs using BASIC, or you can run optional Windows-based software such as 5500/CAL or MET/CAL. The 5500/CAL software includes more than 200 example procedures covering a wide range of test tools the 5500A can calibrate. (See Chapter 6 for a discussion of the RS-232 commands.)

The SERIAL 2 TO UUT serial data port connects a UUT to a PC or terminal via the 5500A (see Figure 1-2). This “pass-through” configuration eliminates the requirement for two COM ports at the PC or Terminal. A set of four commands control the operation of the SERIAL 2 TO UUT serial port. See Chapter 6 for a discussion of the UUT\_\* commands.

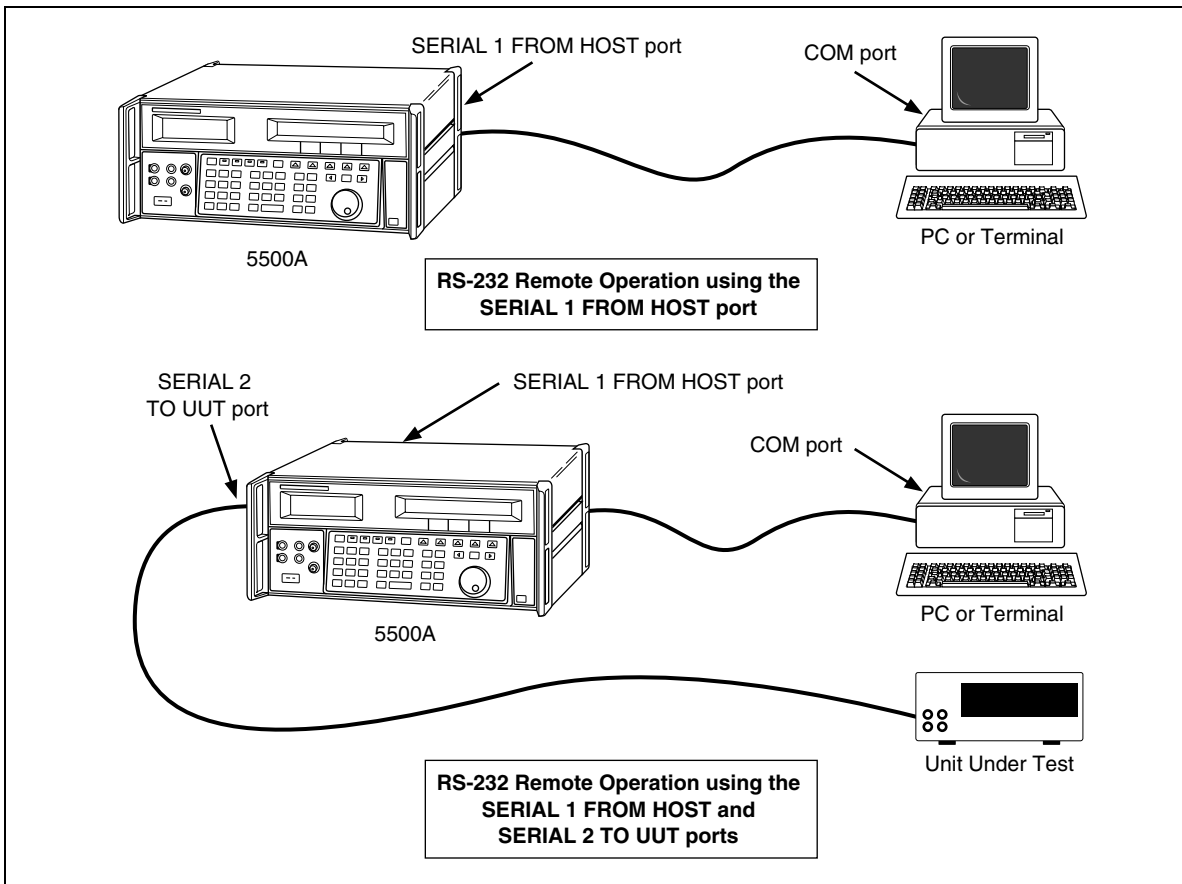

**Figure 1-2. RS-232 Remote Connections**

F1-02.eps

**1-6. Remote Operation (IEEE-488)**

The 5500A rear panel IEEE-488 port is a fully programmable parallel interface bus meeting standard IEEE-488.1 and supplemental standard IEEE-488.2. Under the remote control of an instrument controller, the 5500A Calibrator operates exclusively as a “talker/listener.” You can write your own programs using the IEEE-488 command set or run the optional Windows-based MET/CAL software. (See Chapter 6 for a discussion of the commands available for IEEE-488 operation.)

## **1-7. Where To Go from Here**

To locate specific information concerning the installation and operation of the 5500A calibrator, refer to the following list:

- Unpacking and setup: Chapter 2, “Preparing for Operation”
- Installation and rack mounting: Chapter 2, “Preparing for Operation,” and the rack mount kit instruction sheet
- AC line power and interface cabling: Chapter 2, “Preparing for Operation”
- Controls, indicators, and displays: Chapter 3, “Features”
- Front panel operation: Chapter 4, “Front Panel Operation”
- Cabling to a UUT (Unit Under Test): Chapter 4, “Front Panel Operation”
- Using the auxiliary amplifier: Chapter 4, “Front Panel Operation”
- Remote operation (IEEE-488 or serial): Chapter 5, “Remote Operation”
- Calibrating an Oscilloscope: Chapter 8, “Oscilloscope Calibration Option”
- Accessories to the 5500A Calibrator: Chapter 9, “Accessories”
- Instrument specifications: Chapter 1, “Introduction and Specifications”

## **1-8. Instruction Manuals**

The 5500A Manual Set provides complete information for operators and service or maintenance technicians. The set includes:

- *5500A Getting Started Manual* (PN 945159)
- *5500A Operator Reference Guide* (PN 945097)
- *5500A Remote Programming Reference Guide* (PN 105783)
- *5500A Operator Manual* (Provided on CD-ROM or printed copy available for purchase (PN 1628802) through the Fluke Service Department.)
- *5500A Service Manual* (PN 105798)

The two reference guides and the Getting Started manual are shipped with the unit. Order additional copies of the manuals or reference guides separately using the part number provided. For ordering instructions, refer to the Fluke Catalog, or ask a Fluke sales representative (see “Service Information” in Chapter 2). The Operator and Service Manuals are both provided on the CD-ROM.

## **1-9. 5500A Operator Manual**

This *5500A Operator Manual* provides complete information for installing the 5500A Calibrator and operating it from the front panel keys and in remote configurations. This manual also provides a glossary of calibration, specifications, and error code information. The Operator Manual includes the following topics:

- Installation
- Operating controls and features, including front panel operation
- Remote operation (IEEE-488 bus or serial port remote control)
- Serial port operation (printing, displaying, or transferring data, and setting up for serial port remote control)

- Operator maintenance, including verification procedures and calibration approach for the 5500A
- Oscilloscope Calibration Option
- Accessories

**1-10. 5500A Operator Reference Guide**

The 5500A Operator Reference Guide contains a summary of operating instructions, and a front panel and rear panel feature reference.

**1-11. 5500A Remote Programming Reference Guide**

The 5500A Remote Programming Reference Guide contains a summary of remote commands and reference information useful in determining system status using the status byte and related registers.

**1-12. 5500A Service Manual**

The 5500A Service Manual can be ordered through your local Fluke Sales or Service representative (see “Service Information” in Chapter 2). The 5500A Service Manual includes: theory of operation, performance testing, maintenance, calibration, troubleshooting, parts lists, and schematic diagrams.

**1-13. 5725A Amplifier**

The Fluke 5725A Amplifier (Figure 1-3) is an external unit operating under 5500A control to extend the Volts x Hertz and voltage compliance of the calibrator. The amplifier adds the following capabilities with no compromise in accuracy:

Frequency Increase to 100 kHz at 750 V, 30 kHz at 1020 V.

AC Voltage Load limit extended to 70 mA for frequencies above 5 kHz, and to 50 mA for frequencies less than 5 kHz. Capacitive drive increases to 1020 pF, subject to the maximum output current, for volts ac.

AC Current 11 A load limit extended to 10 kHz, with a 3-volt drive compliance.

A separate set of binding posts on the front panel of the 5725A supplies extended capability. Since most meters have a separate input terminal for the high current ranges, this eliminates the need to change cables during a procedure.

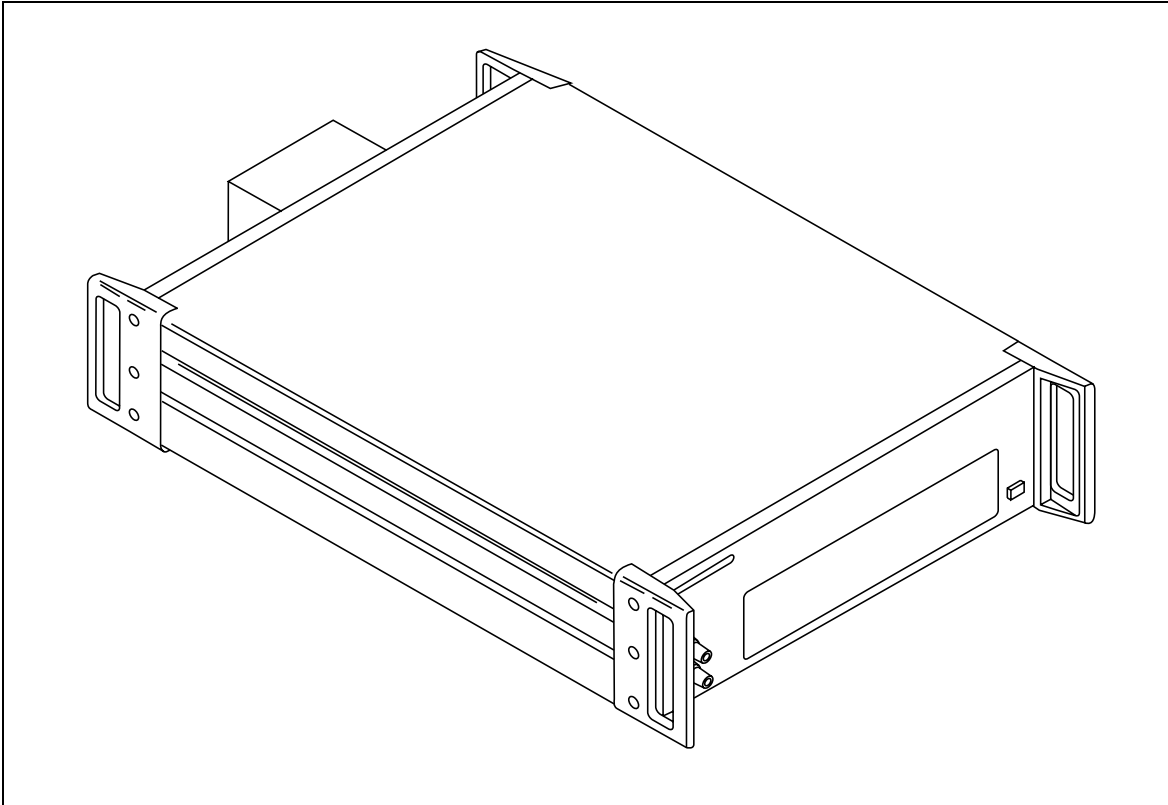

**Figure 1-3. 5725A Amplifier**

F1-03.eps

## 1-14. Specifications

The following paragraphs detail specifications for the 5500A Calibrator. The specifications are valid after allowing a warm-up period of 30 minutes, or twice the time the 5500A has been turned off. For example, if the 5500A has been turned off for 5 minutes, the warm-up period is 10 minutes.

All specifications apply for the temperature and time period indicated. For temperatures outside of  $t_{cal} \pm 5\text{ }^{\circ}\text{C}$  ( $t_{cal}$  is the ambient temperature when the 5500A was calibrated), the temperature coefficient is less than 0.1 times the 90-day specifications per  $^{\circ}\text{C}$  (limited to  $0\text{ }^{\circ}\text{C}$  to  $50\text{ }^{\circ}\text{C}$ ). These specifications also assume the 5500A Calibrator is zeroed every seven days or when the ambient temperature changes more than  $5\text{ }^{\circ}\text{C}$ . (See "Zeroing the Calibrator" in Chapter 4 of the 5500A Operator Manual.)

Also see additional specifications later in this chapter for information on extended specifications for ac voltage and current. The dimensional outline for the 5500A Calibrator is shown in Figure A.

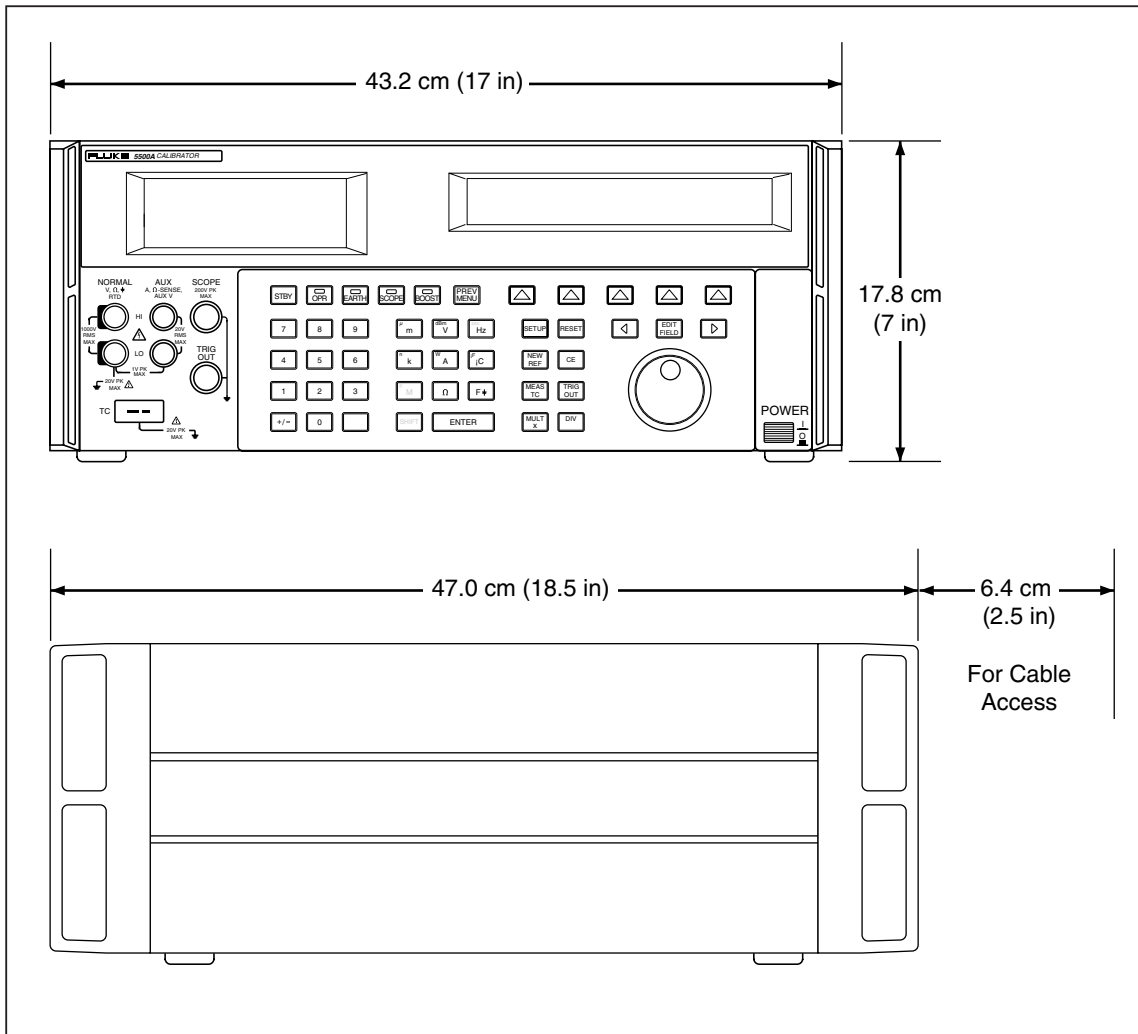

Figure A. 5500A Calibrator Dimensional Outline

om002f.ewps

## 1-15. General Specifications

<b>Warmup Time</b>	Twice the time since last warmed up, to a maximum of 30 minutes.
<b>Settling Time</b>	Less than 5 seconds for all functions and ranges except as noted.
<b>Standard Interfaces</b>	IEEE-488 (GPIB), RS-232, 5725 <sup>a</sup> Amplifier
<b>Temperature Performance</b>	<ul style="list-style-type: none"> <li>• Operating: 0 °C to 50 °C</li> <li>• Calibration (tcal): 15 °C to 35 °C</li> <li>• Storage: -20 °C to 70 °C</li> </ul>
<b>Temperature Coefficient</b>	Temperature Coefficient for temperatures outside tcal +5 °C is 0.1X/ °C of the 90-day specification (or 1-year, as applicable) per °C.
<b>Relative Humidity</b> <sup>[1]</sup>	<ul style="list-style-type: none"> <li>• Operating: &lt;80 % to 30 °C, &lt;70 % to 40 °C, &lt;40 % to 50 °C</li> <li>• Storage: &lt;95 %, non-condensing</li> </ul>
<b>Altitude</b>	<ul style="list-style-type: none"> <li>• Operating: 3,050 m (10,000 ft) maximum</li> <li>• Non-operating: 12,200 m (40,000 ft) maximum</li> </ul>
<b>Safety</b>	Complies with IEC 1010-1 (1992-1); ANSI/ISA-S82.01-1994; CAN/CSA-C22.2 No. 1010.1-92
<b>Analog Low Isolation</b>	20 V
<b>EMC</b>	Designed to comply with FCC Rules Part 15; VFG 243/1991. If used in areas with Electromagnetic fields of 1 to 3 V/m, resistance outputs have a floor adder of 0.508 Ω. Performance not specified above 3 V/m. This instrument may be susceptible to electro-static discharge (ESD) from direct contact to the binding posts. Good static aware practices should be followed when handling this and other pieces of electronic equipment.
<b>Line Power</b>	<ul style="list-style-type: none"> <li>• Line Voltage (selectable): 100 V, 120 V, 220 V, 240 V</li> <li>• Line Frequency: 47 Hz to 63 Hz</li> <li>• Line Voltage Variation: ±10 % about line voltage setting</li> </ul>
<b>Power Consumption</b>	5500A Calibrator, 300 VA; 5725A Amplifier, 750 VA
<b>Dimensions</b>	<p>5500A Calibrator:</p> <ul style="list-style-type: none"> <li>• Height: 17.8 cm (7 in), standard rack increment, plus 1.5 cm (0.6 in) for feet on bottom of unit</li> <li>• Width, 43.2 cm (17 in), standard rack width</li> <li>• Depth: 47.3 cm (18.6 in) overall</li> </ul> <p>5725A Amplifier:</p> <ul style="list-style-type: none"> <li>• Height, 13.3 cm (5.25 in), standard rack increment, plus 1.5 cm (0.6 in) for feet on bottom of unit</li> <li>• Width, 43.2 cm (17 in), standard rack width</li> <li>• Depth, 63.0 cm (24.8 in) overall.</li> </ul>
<b>Weight (without options)</b>	5500A Calibrator, 22 kg (49 lb); 5725A Amplifier 32 kg (70 lb)
<b>Absolute Uncertainty Definition</b>	The 5500A specifications include stability, temperature coefficient, linearity, line and load regulation, and the traceability of the external standards used for calibration. You do not need to add anything to determine the total specification of the 5500A for the temperature range indicated.
<b>Specification Confidence Interval</b>	99 %
[1] After long periods of storage at high humidity, a drying out period (with the power on) of at least one week may be required.	

**1-16. DC Voltage Specifications**

Range	Absolute Uncertainty, tcal $\pm 5$ °C $\pm$ (% of output + $\mu$ V)				Stability 24 hours, $\pm 1$ °C $\pm$ (ppm output + $\mu$ V)	Resolution $\mu$ V	Maximum Burden <sup>[1]</sup>
	90 days		1 year				
0 to 329.9999 mV	0.005	3	0.006	3	5 + 1	0.1	50 $\Omega$
0 to 3.299999 V	0.004	5	0.005	5	4 + 3	1	10 mA
0 to 32.99999 V	0.004	50	0.005	50	4 + 30	10	10 mA
30 to 329.9999 V	0.0045	500	0.0055	500	4.5 + 300	100	5 mA
100 to 1020.000 V	0.0045	1500	0.0055	1500	4.5 + 900	1000	5 mA
<b>Auxiliary Output (dual output mode only) <sup>[2]</sup></b>							
0 to 329.999 mV	0.03	350	0.04	350	30 + 100	1	5 mA
0.33 to 3.3 V	0.03	350	0.04	350	30 + 100	10	5 mA
<p>[1] Remote sensing is not provided. Output resistance is <math>&lt; 5</math> m<math>\Omega</math> for outputs <math>\geq 0.33</math> V. The AUX output has an output resistance of <math>&lt; 1</math> <math>\Omega</math>.</p> <p>[2] Two channels of dc voltage output are provided.</p>							

Range	Noise	
	Bandwidth 0.1 to 10 Hz p-p $\pm$ (ppm output + $\mu$ V)	Bandwidth 10 to 10 kHz rms
0 to 329.9999 mV	1 $\mu$ V	4 $\mu$ V
0 to 3.299999 V	10 $\mu$ V	50 $\mu$ V
0 to 32.99999 V	100 $\mu$ V	600 $\mu$ V
30 to 329.9999 V	10 ppm + 1 mV	20 mV
100 to 1020.000 V	10 ppm + 5 mV	20 mV
<b>Auxiliary Output (dual output mode only) <sup>[1]</sup></b>		
0 to 329.999 mV	5 $\mu$ V	20 $\mu$ V
0.33 to 3.3 V	20 $\mu$ V	200 $\mu$ V
<p>[1] Two channels of dc voltage output are provided.</p>		

### 1-17. DC Current Specifications

Range	Absolute Uncertainty, tcal ± 5 °C ± (% of output + μA)				Resolution	Compliance Voltage	Maximum Inductive Load
	90 days		1 year				
0 to 3.29999 mA	0.010	0.05	0.013	0.05	0.01 μA	4.5 V	1 μH
0 to 32.9999 mA	0.008	0.25	0.01	0.25	0.1 μA	4.5 V	200 μH
0 to 329.999 mA	0.008	3.3	0.01	3.3	1 μA	4.5 to 3.0 V <sup>[1]</sup>	200 μH
0 to 2.19999 A	0.023	44	0.03	44	10 μA	4.5 to 3.4 V <sup>[2]</sup>	200 μH
0 to 11 A	0.038	330	0.06	330	100 μA	4.3 to 2.5 V <sup>[3]</sup>	200 μH
<b>5725A Amplifier</b>							
0 to 11 A	0.03	330	0.04	330	100	4 V	400 μH
<p>[1] The actual voltage compliance (Vc) is a function of current output (Io), and is given by the formula: Vc = -5.05*Io+4.67. The highest compliance voltage is limited to 4.5 V.</p> <p>[2] The actual voltage compliance (Vc) is a function of current output (Io), and is given by the formula: Vc = -0.588*Io+4.69. The highest compliance voltage is limited to 4.5 V.</p> <p>[3] The actual voltage compliance (Vc) is a function of current output (Io), and is given by the formula: Vc = -0.204*Io+4.75. The highest compliance voltage is limited to 4.3 V.</p>							

Ranges	Noise	
	Bandwidth 0.1 to 10 Hz p-p	Bandwidth 10 to 10 kHz rms
0 to 3.29999 mA	20 nA	200 nA
0 to 32.9999 mA	200 nA	2.0 μA
0 to 329.999 mA	2000 nA	20 μA
0 to 2.19999 A	20 μA	1 mA
0 to 11 A	200 μA	10 mA
<b>5725A Amplifier</b>		
0 to 11 A	± 25 ppm of output + 200 nA	2 mA



**1-18. Resistance Specifications**

Range <sup>[1]</sup>	Absolute Uncertainty, tcal ± 5 °C ± (% of output + Ω) <sup>[2]</sup>				Resolution Ω	Allowable Current <sup>[4]</sup>
	90 days		1 year			
0 to 10.99 Ω	0.009	0.008 <sup>[3]</sup>	0.012	0.008 <sup>[3]</sup>	0.001	1 to 125 mA
11 to 32.999 Ω	0.009	0.015 <sup>[3]</sup>	0.012	0.015 <sup>[3]</sup>	0.001	1 to 125 mA
33 to 109.999 Ω	0.007	0.015 <sup>[3]</sup>	0.009	0.015 <sup>[3]</sup>	0.001	1 to 70 mA
110 to 329.999 Ω	0.007	0.015 <sup>[3]</sup>	0.009	0.015 <sup>[3]</sup>	0.001	1 to 40 mA
330 Ω to 1.09999 kΩ	0.007	0.06	0.009	0.06	0.01	250 μA to 18 mA
1.1 to 3.29999 kΩ	0.007	0.06	0.009	0.06	0.01	250 μA to 5 mA
3.3 to 10.9999 kΩ	0.007	0.6	0.009	0.6	0.1	25 μA to 1.8 mA
11 to 32.9999 kΩ	0.007	0.6	0.009	0.6	0.1	25 μA to 0.5 mA
33 to 109.999 kΩ	0.008	6	0.011	6	1	2.5 μA to 0.18 mA
110 to 329.999 kΩ	0.009	6	0.012	6	1	2.5 μA to 0.05 mA
330 kΩ to 1.09999 MΩ	0.011	55	0.015	55	10	250 nA to 0.018 mA
1.1 to 3.29999 MΩ	0.011	55	0.015	55	10	250 nA to 5 μA
3.3 to 10.9999 MΩ	0.045	550	0.06	550	100	25 nA to 1.8 μA
11 to 32.9999 MΩ	0.075	550	0.1	550	100	25 nA to 0.5 μA
33 to 109.999 MΩ	0.4	5500	0.5	5500	1000	2.5 nA to 0.18 μA
110 to 330 MΩ	0.4	16500	0.5	16500	1000	2.5 nA to 0.06 μA

[1] Continuously variable from 0 to 330 MΩ.  
 [2] Applies for COMP OFF (to the 5500A Calibrator front panel NORMAL terminals) and 2-wire and 4-wire compensation.  
 [3] The floor adder is improved to 0.006 Ω (0 to 10.99 Ω range) and 0.010 Ω (11 to 329.999 Ω) if the 5500A Calibrator is zeroed (ohms zero or instrument zero) within 8 hours and temperature is ±1 °C of zeroing ambient temperature.  
 [4] Do not exceed the largest current for each range. For currents lower than shown, the floor adder increases by Floor(new) = Floor(old) x Imin/lactual. For example, a 100 μA stimulus measuring 100 Ω has a floor uncertainty of 0.01 Ω x 1 mA/100 μA = 0.1 Ω.

Range	Maximum Voltage <sup>[1]</sup>	Maximum Lead Resistance <sup>[2]</sup>
0 to 10.99 Ω	1.37 V	<3.2 Ω
11 to 32.999 Ω	4.12 V	<3.2 Ω
33 to 109.999 Ω	7.7 V	<3.2 Ω
110 to 329.999 Ω	13.2 V	<3.2 Ω
330 Ω to 1.09999 kΩ	19.8 V	<6 Ω
1.1 to 3.29999 kΩ	16.5 V	<6 Ω
3.3 to 10.9999 kΩ	19.8 V	<6 Ω
11 to 32.9999 kΩ	16.5 V	<6 Ω
33 to 109.999 kΩ	19.8 V	<6 Ω
110 to 329.999 kΩ	16.5 V	(n/a 110 kΩ and above)
330 kΩ to 1.09999 MΩ	19.8 V	
1.1 to 3.29999 MΩ	16.5 V	
3.3 to 10.9999 MΩ	19.8 V	
11 to 32.9999 MΩ	16.5 V	
33 to 109.999 MΩ	19.8 V	
110 to 330 MΩ	19.8 V	

[1] This is for the largest resistance for each range. The maximum voltage for other values is I<sub>max</sub> (highest value of Allowable Current above) multiplied by Rout.  
 [2] Maximum lead resistance for no additional error in 2-wire COMP.

**1-19. AC Voltage (Sine Wave) Specifications**

Range	Frequency	Absolute Uncertainty, tcal ± 5 °C ± (% of output + μV)				Resolution	Max Burden <sup>[1]</sup>
		90 days		1 year			
1.0 to 32.999 mV	10 to 45 Hz	0.26	20	0.35	20	1 μV	50 Ω
	45 Hz to 10 kHz	0.11	20	0.15	20		
	10 to 20 kHz	0.15	20	0.2	20		
	20 to 50 kHz	0.19	20	0.25	20		
	50 to 100 kHz	0.26	33	0.35	33		
	100 to 500 kHz	0.75	60	1	60		
33 to 329.999 mV	10 to 45 Hz	0.19	50	0.25	50	1 μV	50 Ω
	45 Hz to 10 kHz	0.04	20	0.05	20		
	10 to 20 kHz	0.08	20	0.1	20		
	20 to 50 kHz	0.12	40	0.16	40		
	50 to 100 kHz	0.17	170	0.24	170		
	100 to 500 kHz	0.53	330	0.7	330		
0.33 to 3.29999 V	10 to 45 Hz	0.11	250	0.15	250	10 μV	10 mA
	45 Hz to 10 kHz	0.02	60	0.03	60		
	10 to 20 kHz	0.06	60	0.08	60		
	20 to 50 kHz	0.10	300	0.14	300		
	50 to 100 kHz	0.17	1700	0.24	1700		
	100 to 500 kHz	0.38	3300	0.5	3300		
3.3 to 32.9999 V	10 to 45 Hz	0.11	2500	0.15	2500	100 μV	10 mA
	45 Hz to 10 kHz	0.03	600	0.04	600		
	10 to 20 kHz	0.06	2600	0.08	2600		
	20 to 50 kHz	0.14	5000	0.19	5000		
	50 to 100 kHz	0.17	17000	0.24	17000		
33 to 329.999 V	45 Hz to 1 kHz	0.04	6.6 mV	0.05	6.6 mV	1 mV	5 mA, except 20 mA for 45 to 65 Hz
	1 to 10 kHz	0.06	15	0.08	15		
	10 to 20 kHz	0.07	33	0.09	33		
330 to 1020 V	45 Hz to 1 kHz	0.04	80 mV	0.05	80 mV	10 mV	2 mA, except 6 mA for 45 to 65 Hz
	1 to 5 kHz	0.15	100	0.20	100		
	5 to 10 kHz	0.15	500	0.20	500		

**AC Voltage (Sine Wave) Specifications (cont.)**

Range	Frequency	Absolute Uncertainty, tcal $\pm 5^\circ\text{C}$ $\pm$ (% of output + $\mu\text{V}$ )				Resolution	Maximum Burden <sup>[1]</sup>
		90 days		1 year			
<b>5725A Amplifier</b>							
100 to 1020 V	45 Hz to 1 kHz	0.04	80 mV	0.05	80 mV	10 mV	50 mA
	1 to 20 kHz	0.06	100 mV	0.08	100 mV		70 mA
	20 to 30 kHz	0.08	100 mV	0.10	100 mV		70 mA
100 to 750 V	30 to 100 kHz	0.38	500 mV	0.5	500 mV		70 mA
<b>Auxiliary Output [dual output mode only] <sup>[2]</sup></b>							
10 to 329.999 mV	10 to 20 Hz	0.15	370	0.2	370	1 $\mu\text{V}$	5 mA
	20 to 45 Hz	0.08	370	0.1	370		
	45 Hz to 1 kHz	0.08	370	0.1	370		
	1 to 5 kHz	0.15	450	0.2	450		
	5 to 10 kHz	0.3	450	0.4	450		
0.33 to 3.29999 V	10 to 20 Hz	0.15	450	0.2	450	10 $\mu\text{V}$	5 mA
	20 to 45 Hz	0.08	450	0.1	450		
	45 Hz to 1 kHz	0.07	450	0.09	450		
	1 to 5 kHz	0.15	1400	0.2	1400		
	5 to 10 kHz	0.3	1400	0.4	1400		
<p>[1] Remote sensing is not provided. Output resistance is <math>&lt; 5\ \text{m}\Omega</math> for outputs <math>\geq 0.33\ \text{V}</math>. The AUX output resistance is <math>&lt; 1\ \Omega</math>. The maximum load capacitance is 500 pF, subject to the maximum burden current limits.</p> <p>[2] There are two channels of voltage output. The maximum frequency of the dual output is 10 kHz.</p>							

**AC Voltage (Sine Wave) Specifications (cont.)**

Range	Frequency	Maximum Distortion and Noise 10 Hz to 5 MHz Bandwidth $\pm$ (% output + $\mu$ V)
1.0 to 32.999 mV	10 to 45 Hz	0.15 + 90
	45 Hz to 10 kHz	0.035 + 90
	10 to 20 kHz	0.06 + 90
	20 to 50 kHz	0.15 + 90
	50 to 100 kHz	0.25 + 90
33 to 329.999 mV	100 to 500 kHz	0.3 + 90
	10 to 45 Hz	0.15 + 90
	45 Hz to 10 kHz	0.035 + 90
	10 to 20 kHz	0.06 + 90
	20 to 50 kHz	0.15 + 90
0.33 to 3.29999 V	50 to 100 kHz	0.20 + 90
	100 to 500 kHz	0.20 + 90
	10 to 45 Hz	0.15 + 200
	45 Hz to 10 kHz	0.035 + 200
	10 to 20 kHz	0.06 + 200
	20 to 50 kHz	0.15 + 200
3.3 to 32.9999 V	50 to 100 kHz	0.20 + 200
	100 to 500 kHz	0.20 + 200
	10 to 45 Hz	0.15 + 2 mV
	45 Hz to 10 kHz	0.035 + 2 mV
	10 to 20 kHz	0.08 + 2 mV
33 to 329.999 V	20 to 50 kHz	0.2 + 2 mV
	50 to 100 kHz	0.5 + 2 mV
	45 Hz to 1 kHz	0.15 + 10 mV
	1 to 10 kHz	0.05 + 10 mV
330 to 1000 V	10 to 20 kHz	0.6 + 10 mV
	45 Hz to 1 kHz	0.15 + 30 mV
	1 to 10 kHz	0.07 + 30 mV
<b>5725A Amplifier</b>		
100 to 1020 V	45 Hz to 1 kHz	0.07 %
	1 to 20 kHz	0.15 %
	20 to 30 kHz	0.3 %
100 to 750 V	30 to 100 kHz	0.4 %
<b>Auxiliary Output (dual output mode only) 10 Hz to 100 kHz Bandwidth</b>		
10 to 329.999 mV	10 to 20 Hz	0.2 + 200
	20 to 45 Hz	0.06 + 200
	45 Hz to 1 kHz	0.08 + 200
	1 to 5 kHz	0.3 + 200
	5 to 10 kHz	0.6 + 200
0.33 to 3.29999 V	10 to 20 Hz	0.2 + 200
	20 to 45 Hz	0.06 + 200
	45 Hz to 1 kHz	0.08 + 200
	1 to 5 kHz	0.3 + 200
	5 to 10 kHz	0.6 + 200

**1-20. AC Current (Sine Wave) Specifications**

Range	Frequency	Absolute Uncertainty, tcal ± 5 °C ± (% of output + μA)				Resolution	Compliance Voltage	Max Inductive Load
		90 days		1 year				
0.029 to 0.32999 mA	10 to 20 Hz	0.19	0.15	0.25	0.15	0.01 μA	3.0 V rms	1 μH
	20 to 45 Hz	0.09	0.15	0.125	0.15			
	45 Hz to 1 kHz	0.09	0.25	0.125	0.25			
	1 to 5 kHz	0.30	0.15	0.4	0.15			
	5 to 10 kHz	0.94	0.15	1.25	0.15			
0.33 to 3.2999 mA	10 to 20 Hz	0.15	0.3	0.2	0.3	0.01 μA	3.0 V rms	1 μH
	20 to 45 Hz	0.08	0.3	0.1	0.3			
	45 Hz to 1 kHz	0.08	0.3	0.1	0.3			
	1 to 5 kHz	0.15	0.3	0.2	0.3			
	5 to 10 kHz	0.45	0.3	0.6	0.3			
3.3 to 32.999 mA	10 to 20 Hz	0.15	3	0.2	3	0.1 μA	3.0 V rms	200 μH, 10 to 500 Hz
	20 to 45 Hz	0.08	3	0.1	3			1 μH, 500 Hz to 10 kHz
	45 Hz to 1 kHz	0.07	3	0.09	3			
	1 to 5 kHz	0.15	3	0.2	3			
	5 to 10 kHz	0.45	3	0.6	3			
33 to 329.99 mA	10 to 20 Hz	0.15	30	0.2	30	1 μA	3.0 to 2.0 V rms <sup>[1]</sup>	200 μH, 10 to 500 Hz
	20 to 45 Hz	0.08	30	0.1	30			5 μH, 500 Hz to 10 kHz
	45 Hz to 1 kHz	0.07	30	0.09	30			
	1 to 5 kHz	0.15	30	0.2	30			
	5 to 10 kHz	0.45	30	0.6	30			
0.33 to 2.19999 A	10 to 45 Hz	0.15	300	0.2	300	10 μA	3.0 to 2.0 V rms <sup>[2]</sup>	200 μH, 45 to 500 Hz
	45 Hz to 1 kHz	0.08	300	0.1	300			5 μH, 500 Hz to 5 kHz
	1 to 5 kHz	0.7	300	0.75	300			
2.2 to 11 A	45 to 65 Hz	0.05	2000	0.06	2000	100 μA	2.8 to 1.25 V rms <sup>[3]</sup>	200 μH, 45 to 65 Hz
	65 to 500 Hz	0.08	2000	0.10	2000			1 μH, 65 Hz to 1 kHz
	500 Hz to 1 kHz	0.25	2000	0.33	2000			

**AC Current (Sine Wave) Specifications (cont.)**

Range	Frequency	Absolute Uncertainty, $t_{cal} \pm 5^\circ C$ $\pm$ (% of output + $\mu A$ )				Resolution	Compliance Voltage	Max Inductive Load
		90 days		1 year				
<b>5725A Amplifier</b>								
1.5 to 11 A	45 Hz to 1 kHz	0.08	100	0.1	100	100	3	400 $\mu H$
	1 to 5 kHz	0.19	5000	0.25	5000			
	5 to 10 kHz	0.75	10000	1	10000			
<p>[1] The actual voltage compliance (<math>V_c</math>) is a function of current output (<math>I_o</math>), and is given by the formula: <math>V_c = -3.37 \cdot I_o + 3.11</math>. The highest compliance voltage is limited to 3.0 V.</p> <p>[2] The actual voltage compliance (<math>V_c</math>) is a function of current output (<math>I_o</math>), and is given by the formula: <math>V_c = -0.535 \cdot I_o + 3.18</math>. The highest compliance voltage is limited to 3.0 V.</p> <p>[3] The actual voltage compliance (<math>V_c</math>) is a function of current output (<math>I_o</math>), and is given by the formula: <math>V_c = -0.176 \cdot I_o + 3.19</math>. The highest compliance voltage is limited to 2.8 V.</p>								

Range	Frequency	Maximum Distortion and Noise 10 Hz to 100 kHz Bandwidth $\pm$ (% output + $\mu A$ )	
0.02 to 0.32999 mA	10 to 20 Hz	0.15	1.0
	20 to 45 Hz	0.1	1.0
	45 Hz to 1 kHz	0.05	1.0
	1 to 5 kHz	0.5	1.0
	5 to 10 kHz	1.0	1.0
0.33 to 3.2999 mA	10 to 20 Hz	0.15	1.5
	20 to 45 Hz	0.06	1.5
	45 Hz to 1 kHz	0.02	1.5
	1 to 5 kHz	0.5	1.5
	5 to 10 kHz	1.2	1.5
3.3 to 32.999 mA	10 to 20 Hz	0.15	5
	20 to 45 Hz	0.05	5
	45 Hz to 1 kHz	0.07	5
	1 to 5 kHz	0.3	5
	5 to 10 kHz	0.7	5
33 to 329.99 mA	10 to 20 Hz	0.15	50
	20 to 45 Hz	0.05	50
	45 Hz to 1 kHz	0.07	50
	1 to 5 kHz	0.2	50
	5 to 10 kHz	0.4	50
0.33 to 2.19999 A	10 to 45 Hz	0.2	500
	45 Hz to 1 kHz	0.1	500
	1 to 5 kHz	1.4	500
2.2 to 11 A	45 to 65 Hz	0.2	3 mA
	65 to 500 Hz	0.1	3 mA
	500 Hz to 1 kHz	0.4	3 mA
<b>5725A Amplifier</b>			
1.5 to 11 A	45 Hz to 1 kHz	0.05	1 mA
	1 to 5 kHz	0.12	1 mA
	5 to 10 kHz	0.5	1 mA

**1-21. Capacitance Specifications**

Range	Absolute Uncertainty, tcal ± 5 °C ± (% of output + nF)				Resolution	Frequency	
	90 days		1 year			Allowed	Typical for <1 % Error
0.33 to 0.4999 nF	0.38	0.01	0.5	0.01	0.1 pF	50 to 1000 Hz	10 kHz
0.5 to 1.0999 nF	0.38	0.01	0.5	0.01	0.1 pF	50 to 1000 Hz	10 kHz
1.1 to 3.2999 nF	0.38	0.01	0.5	0.01	0.1 pF	50 to 1000 Hz	10 kHz
3.3 to 10.999 nF	0.38	0.01	0.5	0.01	1 pF	50 to 1000 Hz	10 kHz
11 to 32.999 nF	0.19	0.1	0.25	0.1	1 pF	50 to 1000 Hz	10 kHz
33 to 109.99 nF	0.19	0.1	0.25	0.1	10 pF	50 to 1000 Hz	10 kHz
110 to 329.99 nF	0.19	0.3	0.25	0.3	10 pF	50 to 1000 Hz	10 kHz
0.33 to 1.0999 μF	0.19	1	0.25	1	100 pF	50 to 1000 Hz	5 kHz
1.1 to 3.2999 μF	0.26	3	0.35	3	100 pF	50 to 1000 Hz	2 kHz
3.3 to 10.999 μF	0.26	10	0.35	10	1 nF	50 to 400 Hz	1.5 kHz
11 to 32.999 μF	0.30	30	0.40	30	1 nF	50 to 400 Hz	800 Hz
33 to 109.99 μF	0.38	100	0.50	100	10 nF	50 to 200 Hz	400 Hz
110 to 329.99 μF	0.50	300	0.70	300	10 nF	50 to 100 Hz	200 Hz
330 to 1.1 mF	1	300	1	300	100 nF	50 to 100 Hz	150 Hz

Specifications apply to both dc charge/discharge capacitance meters and ac RCL meters.  
The output is continuously variable from 330 pF to 1.1 mF.  
For all ranges, the maximum charge and discharge current is 150 mA pk or 30 mA rms. The peak voltage is 4 V, except the 330 μF to 1.1 mF range is limited to 1 V. The maximum lead resistance for no additional error in 2-wire COMP mode is 10 Ω.

### 1-22. Temperature Calibration (Thermocouple) Specifications

TC Type <sup>[1]</sup>	Range (°C) <sup>[2]</sup>	Absolute Uncertainty Source/Measure, tcal ± 5 °C ± (°C) <sup>[3]</sup>		TC Type <sup>[1]</sup>	Range (°C) <sup>[2]</sup>	Absolute Uncertainty Source/Measure, tcal ± 5 °C ± (°C) <sup>[3]</sup>	
		90 days	1 year			90 days	1 year
B	600 to 800	0.42	0.44	L	-200 to -100	0.37	0.37
	800 to 1000	0.34	0.34		-100 to 800	0.26	0.26
	1000 to 1550	0.30	0.30		800 to 900	0.17	0.17
	1550 to 1820	0.26	0.33				
C	0 to 150	0.23	0.30	N	-200 to -100	0.30	0.40
	150 to 650	0.19	0.26		-100 to -25	0.17	0.22
	650 to 1000	0.23	0.31		-25 to 120	0.15	0.19
	1000 to 1800	0.38	0.50		120 to 410	0.14	0.18
	1800 to 2316	0.63	0.84		410 to 1300	0.21	0.27
E	-250 to -100	0.38	0.50	R	0 to 250	0.48	0.57
	-100 to -25	0.12	0.16		250 to 400	0.28	0.35
	-25 to 350	0.10	0.14		400 to 1000	0.26	0.33
	350 to 650	0.12	0.16		1000 to 1767	0.30	0.40
	650 to 1000	0.16	0.21	S	0 to 250	0.47	0.47
J	-210 to -100	0.20	0.27		250 to 1000	0.30	0.36
	-100 to -30	0.12	0.16		1000 to 1400	0.28	0.37
	-30 to 150	0.10	0.14	1400 to 1767	0.34	0.46	
	150 to 760	0.13	0.17	T	-250 to -150	0.48	0.63
760 to 1200	0.18	0.23	-150 to 0		0.18	0.24	
K	-200 to -100	0.25	0.33		0 to 120	0.12	0.16
	-100 to -25	0.14	0.18		120 to 400	0.10	0.14
	-25 to 120	0.12	0.16	U	-200 to 0	0.56	0.56
	120 to 1000	0.19	0.26		0 to 600	0.27	0.27
	1000 to 1372	0.30	0.40				

The 10 µV/ °C linear output mode has the same uncertainty as the 300 mV dc range.  
Applies to both simulated thermocouple output and thermocouple measurement.

[1] Temperature standard ITS-90 or IPTS-68 is selectable.  
[2] Resolution is 0.01 °C.  
[3] Does not include thermocouple error.



**1-23. Temperature Calibration (RTD) Specifications**

RTD Type	Range °C <sup>[1]</sup>	Absolute Uncertainty tcal ±5 °C ± °C <sup>[2]</sup>		RTD Type	Range °C <sup>[1]</sup>	Absolute Uncertainty tcal ±5 °C ± °C <sup>[2]</sup>	
		90 days	1 year			90 days	1 year
Pt 395, 100 Ω	-200 to -80	0.04	0.05	Pt 385, 500 Ω	-200 to -80	0.03	0.04
	-80 to 0	0.05	0.05		-80 to 0	0.04	0.05
	0 to 100	0.07	0.07		0 to 100	0.05	0.05
	100 to 300	0.08	0.09		100 to 260	0.06	0.06
	300 to 400	0.09	0.10		260 to 300	0.07	0.08
	400 to 630	0.10	0.12		300 to 400	0.07	0.08
	630 to 800	0.21	0.23		400 to 600	0.08	0.09
Pt 3926, 100 Ω	-200 to -80	0.04	0.05	Pt 385, 1000 Ω	600 to 630	0.09	0.11
	-80 to 0	0.05	0.05		-200 to -80	0.03	0.03
	0 to 100	0.07	0.07		-80 to 0	0.03	0.03
	100 to 300	0.08	0.09		0 to 100	0.03	0.04
	300 to 400	0.09	0.10		100 to 260	0.04	0.05
400 to 630	0.10	0.12	260 to 300		0.05	0.06	
Pt 3916, 100 Ω	-200 to -190	0.25	0.25		PtNi 385, 120 Ω (Ni120)	300 to 400	0.05
	-190 to -80	0.04	0.04	400 to 600		0.06	0.07
	-80 to 0	0.05	0.05	600 to 630		0.22	0.23
	0 to 100	0.06	0.06	Cu 427, 10 Ω <sup>[3]</sup>		-100 to 260	0.3
	100 to 260	0.06	0.07				
	260 to 300	0.07	0.08				
	300 to 400	0.08	0.09				
400 to 600	0.08	0.10					
600 to 630	0.21	0.23					
Pt 385, 200 Ω	-200 to -80	0.03	0.04				
	-80 to 0	0.03	0.04				
	0 to 100	0.04	0.04				
	100 to 260	0.04	0.05				
	260 to 300	0.11	0.12				
	300 to 400	0.12	0.13				
	400 to 600	0.12	0.14				
600 to 630	0.14	0.16					

[1] Resolution is 0.003 °C.

[2] Applies for COMP OFF (to the 5500A Calibrator front panel NORMAL terminals) and 2-wire and 4-wire compensation.

[3] Based on MINCO Application Aid No. 18.

### 1-24. DC Power Specification Summary

	Voltage Range	Absolute Uncertainty, tcal ± 5 °C, ± (% of Watts output) <sup>[1]</sup>			
		5500A Calibrator Current Range			
		3.3 to 8.999 mA	9 to 32.999 mA	33 to 89.99 mA	90 to 329.99 mA
90 days	33 mV to 1020 V	0.03	0.02	0.03	0.02
1 year	33 mV to 1020 V	0.04	0.03	0.04	0.03
	Voltage Range	0.33 to 0.8999 A	0.9 to 2.1999 A	2.2 to 4.4999 A	4.5 to 11 A
90 days	33 mV to 1020 V	0.07	0.05	0.08	0.06
1 year	33 mV to 1020 V	0.08	0.06	0.12	0.09
	Voltage Range	5725A Amplifier Current Range			
		1.5 to 4.4999 A	4.5 to 11 A		
90 days	33 mV to 1020 V	0.09		0.07	
1 year	33 mV to 1020 V	0.10		0.08	

[1] To determine dc power uncertainty with more precision, see the individual "DC Voltage Specifications" and "DC Current Specifications" and "Calculating Power Uncertainty."

### 1-25. AC Power (45 Hz to 65 Hz) Specification Summary, PF=1

	Voltage Range	Absolute Uncertainty, tcal ± 5 °C, ± (% of Watts output) <sup>[1]</sup>			
		Current Range			
		3.3 to 8.999 mA	9 to 32.999 mA	33 to 89.99 mA	90 to 329.99 mA
5500A Calibrator					
90 days	33 to 329.999 mV	0.30	0.20	0.25	0.20
	330 mV to 1020 V	0.20	0.12	0.20	0.12
1 year	33 to 329.999 mV	0.40	0.25	0.35	0.25
	330 mV to 1020 V	0.25	0.15	0.25	0.15
5725A Amplifier					
90 days	100 to 1020 V	0.20	0.12	0.20	0.12
1 year	100 to 1020 V	0.25	0.15	0.25	0.15
		0.33 to 0.8999 A	0.9 to 2.1999 A	2.2 to 4.4999 A	4.5 to 11 A
5500A Calibrator					
90 days	33 to 329.999 mV	0.25	0.20	0.25	0.20
	330 mV to 1020 V	0.20	0.12	0.18	0.12
1 year	33 to 329.999 mV	0.35	0.25	0.35	0.25
	330 mV to 1020 V	0.25	0.15	0.20	0.15
5725A Amplifier					
90 days	100 to 1020 V	0.20	0.12	0.18	0.12
1 year	100 to 1020 V	0.25	0.15	0.20	0.15
		1.5 to 4.4999 A		4.5 to 11 A	
5500A Calibrator					
90 days	33 to 329.999 mV	0.25		0.20	
	330 mV to 1020 V	0.15		0.12	
1 year	33 mV to 1020 V	0.35		0.25	
	330 mV to 1020 V	0.20		0.15	

[1] To determine uncertainty with more precision, see "Calculating Power Uncertainty."

**1-26. Power and Dual Output Limit Specifications**

Frequency	Voltages (NORMAL)	Currents	Voltages (AUX)	Power Factor (PF)
DC	0 to $\pm 1020$ V	0 to $\pm 11$ A	0 to $\pm 3.3$ V	—
10 to 45 Hz	33 mV to 32.9999 V	3.3 mA to 2.19999 A	10 mV to 3.3 V	0 to 1
45 to 65 Hz	33 mV to 1020 V	3.3 mA to 11 A	10 mV to 3.3 V	0 to 1
65 to 500 Hz	330 mV to 1020 V	33 mA to 2.19999 A	100 mV to 3.3 V	0 to 1
65 to 500 Hz	3.3 to 1020 V	33 mA to 11 A	100 mV to 3.3 V	0 to 1
500 Hz to 1 kHz	330 mV to 1020 V	33 mA to 11 A	100 mV to 3.3 V	1
1 to 5 kHz	3.3 to 1020 V <sup>[1]</sup>	33 mA to 2.19999 A	100 mV to 3.3 V <sup>[1]</sup>	1
5 to 10 kHz	3.3 to 1020 V <sup>[2]</sup>	33 mA to 329.99 mA	1 to 3.3 V <sup>[2]</sup>	1

[1] In dual volts, voltage is limited to 3.3 to 500 V in the NORMAL output.

[2] In dual volts, voltage is limited to 3.3 to 250 V in the NORMAL output.

- The range of voltages and currents shown in "DC Voltage Specifications," "DC Current Specifications," "AC Voltage (Sine Waves) Specifications," and "AC Current (Sine Wave) Specifications" are available in the power and dual output modes (except minimum current for ac power is 0.33 mA). However, only those limits shown in this table are specified. See "Calculating Power Uncertainty" to determine the uncertainty at these points.
- The phase adjustment range for dual ac outputs is 0 to  $\pm 179.99$  degrees. The phase resolution for dual ac outputs is 0.02 degree.

### 1-27. Phase Specifications

1-Year Absolute Uncertainty, tcal ± 5 °C, (ΔΦ Degrees)				
10 to 65 Hz	65 to 500 Hz	500 Hz to 1 kHz	1 to 5 kHz	5 to 10 kHz
0.15 ° [1]	0.9 ° [2]	2.0 ° [3]	6 °	10 °
[1] For 33 to 1000 V output, burden current <6 mA. For 6 to 20 mA burden current (33 to 330 V), the phase uncertainty is 0.4 degree. [2] For 33 to 1000 V output, burden current <2 mA. For 2 to 5 mA burden current (33 to 330 V), the phase uncertainty is 1.5 degrees. [3] For 33 to 1000 V output, burden current <2 mA. For 2 to 5 mA burden current (33 to 330 V), the phase uncertainty is 5 degrees.				

Phase (Φ) Watts Degrees	Phase (Φ) VARs Degrees	PF	Power Uncertainty Adder due to Phase Error ± (%)				
			10 to 65 Hz	65 to 500 Hz	500 Hz to 1 kHz	1 to 5 kHz	5 to 10 kHz
0	90	1.000	0.00	0.01	0.06	0.55	1.52
5	85	0.996	0.02	0.15	Not Specified		
10	80	0.985	0.05	0.29			
15	75	0.966	0.07	0.43			
20	70	0.940	0.10	0.58			
25	65	0.906	0.12	0.74			
30	60	0.866	0.15	0.92			
35	55	0.819	0.18	1.11			
40	50	0.766	0.22	1.33			
45	45	0.707	0.26	1.58			
50	40	0.643	0.31	1.88			
55	35	0.574	0.37	2.26			
60	30	0.500	0.45	2.73			
65	25	0.423	0.56	3.38			
70	20	0.342	0.72	4.33			
75	15	0.259	0.98	5.87			
80	10	0.174	1.49	8.92			
85	5	0.087	2.99	17.97			
90	0	0.000	—	—			

To calculate exact ac Watts power adders due to phase uncertainty for values not shown, use the following formula:

$$Adder(\%) = 100 \left( 1 - \frac{\cos(\Phi + \Delta\Phi)}{\cos(\Phi)} \right)$$

For example: for a PF of .9205 (Φ = 23) and a phase uncertainty of ΔΦ = 0.15, the ac Watts power adder is:

$$Adder(\%) = 100 \left( 1 - \frac{\cos(23+0.15)}{\cos(23)} \right) = 0.11\%$$

### 1-28. Calculating Power Uncertainty

Overall uncertainty for power output in Watts (or VARs) is based on the root sum square (rss) of the individual uncertainties in percent for the selected voltage, current, and power factor parameters:

$$\text{Watts uncertainty } U_{\text{power}} = \sqrt{U_{\text{voltage}}^2 + U_{\text{current}}^2 + U_{\text{PFadder}}^2}$$

$$\text{VARs uncertainty } U_{\text{VARs}} = \sqrt{U_{\text{voltage}}^2 + U_{\text{current}}^2 + U_{\text{VARsadder}}^2}$$

Because there are an infinite number of combinations, you should calculate the actual ac power uncertainty for your selected parameters. The method of calculation is best shown in the following examples (using 90-day specifications):

**Example 1** Output: 100 V, 1 A, 60 Hz, Power Factor = 1.0 ( $\Phi=0$ )

**Voltage Uncertainty** Uncertainty for 100 V at 60 Hz is 0.04 % + 6.6 mV, totaling:  
 $100 \text{ V} \times .0004 = 40 \text{ mV}$  added to 6.6 mV = 46.6 mV. Expressed in percent:  
 $46.6 \text{ mV}/100 \text{ V} \times 100 = 0.047 \%$  (see "AC Voltage (Sine Wave) Specifications").

**Current Uncertainty** Uncertainty for 1 A is 0.08 % + 300  $\mu\text{A}$ , totaling:  
 $1 \text{ A} \times .0008 = 800 \mu\text{A}$  added to 300  $\mu\text{A} = 1.1 \text{ mA}$ . Expressed in percent:  
 $1.1 \text{ mA}/1 \text{ A} \times 100 = 0.11 \%$  (see "AC Current (Sine Waves) Specifications").

**PF Adder** Watts Adder for PF = 1 ( $\Phi=0$ ) at 60 Hz is 0 % (see "Phase Specifications").

$$\text{Total Watts Output Uncertainty} = U_{\text{power}} = \sqrt{0.047^2 + 0.11^2 + 0^2} = 0.12\%$$

**Example 2** Output: 100 V, 1 A, 400 Hz, Power Factor = 0.5 ( $\Phi=60$ )

**Voltage Uncertainty** Uncertainty for 100 V at 400 Hz is 0.04 % + 6.6 mV, totaling:  
 $100 \text{ V} \times .0004 = 40 \text{ mV}$  added to 6.6 mV = 46.6 mV. Expressed in percent:  
 $46.6 \text{ mV}/100 \text{ V} \times 100 = 0.047 \%$  (see "AC Voltage (Sine Wave) Specifications").

**Current Uncertainty** Uncertainty for 1 A is 0.08 % + 300  $\mu\text{A}$ , totaling:  
 $1 \text{ A} \times .0008 = 800 \mu\text{A}$  added to 300  $\mu\text{A} = 1.1 \text{ mA}$ . Expressed in percent:  
 $1.1 \text{ mA}/1 \text{ A} \times 100 = 0.11 \%$  (see "AC Current (Sine Wave) Specifications").

**PF Adder** Watts Adder for PF = 0.5 ( $\Phi=60$ ) at 400 Hz is 2.73 % (see "Phase Specifications").

$$\text{Total Watts Output Uncertainty} = U_{\text{power}} = \sqrt{0.047^2 + 0.11^2 + 2.73^2} = 2.73\%$$

**VARs** When the Power Factor approaches 0.0, the Watts output uncertainty becomes unrealistic because the dominant characteristic is the VARs (volts-amps-reactive) output. In these cases, calculate the Total VARs Output Uncertainty, as shown in example 3:

**Example 3** Output: 100 V, 1 A, 60 Hz, Power Factor = 0.0872 ( $\Phi=85$ )

**Voltage Uncertainty** Uncertainty for 100 V at 60 Hz is 0.04 % + 6.6 mV, totaling:  
 $100 \text{ V} \times .0004 = 40 \text{ mV}$  added to 6.6 mV = 46.6 mV. Expressed in percent:  
 $46.6 \text{ mV}/100 \text{ V} \times 100 = 0.047 \%$  (see "AC Voltage (Sine Wave) Specifications").

**Current Uncertainty** Uncertainty for 1 A is 0.08 % + 300  $\mu\text{A}$ , totaling:  
 $1 \text{ A} \times .0008 = 800 \mu\text{A}$  added to 300  $\mu\text{A} = 1.1 \text{ mA}$ . Expressed in percent:  
 $1.1 \text{ mA}/1 \text{ A} \times 100 = 0.11 \%$  (see "AC Current (Sine Wave) Specifications").

**VARs Adder** VARs Adder for  $\Phi=85$  at 60 Hz is 0.02 % (see "Phase Specifications").

$$\text{Total VARs Output Uncertainty} = U_{\text{VARs}} = \sqrt{0.047^2 + 0.11^2 + 0.02^2} = 0.12\%$$

## 1-29. Additional Specifications

The following paragraphs provide additional specifications for the 5500A Calibrator ac voltage and ac current functions. These specifications are valid after allowing a warm-up period of 30 minutes, or twice the time the 5500A has been turned off. All extended range specifications are based on performing the internal zero-cal function at weekly intervals, or when the ambient temperature changes by more than 5 °C. (See Chapter 4, Front Panel Operations in the 5500A Operator Manual.)

### 1-30. Frequency Specifications

Frequency Range	Resolution	1-Year Absolute Uncertainty, tcal ± 5 °C		Jitter
		± (PPM + mHz)		
0.01 - 119.99 Hz	0.01 Hz	25	1	2 μs
120.0 - 1199.9 Hz	0.1 Hz	25	1	2 μs
1.200 - 11.999 kHz	1.0 Hz	25	1 <sup>[1]</sup>	2 μs
12.00 - 119.99 kHz	10 Hz	25	15	140 ns
120.0 - 1199.9 kHz	100 Hz	25	15	140 ns
1.200 - 2.000 MHz	1 kHz	25	15	140 ns

[1] ± (25 ppm + 15 mHz) above 10 kHz

### 1-31. Harmonics (2<sup>nd</sup> to 50<sup>th</sup>) Specifications

Fundamental Frequency <sup>[1]</sup>	Voltages NORMAL Terminals	Currents	Voltages AUX Terminals	Amplitude Uncertainty
10 to 45 Hz	33 mV to 32.9999 V	3.3 mA to 2.19999 A	10 mV to 3.3 V	Same % of output as the equivalent single output, but twice the floor adder.
45 to 65 Hz	33 mV to 1020 V	3.3 mA to 11 A	10 mV to 3.3 V	
65 to 500 Hz	33 mV to 1020 V	33 mA to 11 A	100 mV to 3.3 V	
500 to 1 kHz	330 mV to 1020 V	33 mA to 11 A	100 mV to 3.3 V	
1 to 5 kHz	3.3 to 1020 V	33 mA to 2.19999 A	100 mV to 3.3 V	

Phase uncertainty for harmonic outputs is 1 degree, or the phase uncertainty shown in "Phase Specifications" for the particular output, whichever is greater. For example, the phase uncertainty of a 400 Hz fundamental output and 10 kHz harmonic output is 10 degrees (from "Phase Specifications"). Another example, the phase uncertainty of a 60 Hz fundamental output and a 400 Hz harmonic output is 1 degree.

[1] The maximum frequency of the harmonic output is 10 kHz. For example, if the fundamental output is 5 kHz, the maximum selection is the 2<sup>nd</sup> harmonic (10 kHz). All harmonic frequencies (2<sup>nd</sup> to 50<sup>th</sup>) are available for fundamental outputs between 10 and 200 Hz.

Example of determining Amplitude Uncertainty in a Dual Output Harmonic Mode

What are the amplitude uncertainties for the following dual outputs?

NORMAL (Fundamental) Output:

100 V, 100 Hz ..... From "AC Voltage (Sine Wave) Specifications" the single output specification for 100 V, 100 Hz, is 0.015 % + 2 mV. For the dual output in this example, the specification is 0.015 % + 4 mV as the 0.015 % is the same, and the floor is twice the value (2 x 2 mV).

AUX (50<sup>th</sup> Harmonic) Output:

100 mV, 5 kHz ..... From "AC Voltage (Sine Wave) Specifications" the auxiliary output specification for 100 mV, 5 kHz, is 0.15 % + 450 mV. For the dual output in this example, the specification is 0.15 % + 900 mV as the 0.15 % is the same, and the floor is twice the value (2 x 450 mV).

**1-32. AC Voltage (Sine Wave) Extended Bandwidth Specifications**

Range	Frequency	1-Year Absolute Uncertainty, tcal ± 5 °C, ± (% of output + % of range)		Maximum Voltage Resolution
		% Output	% Range	
<b>Normal Channel (Single Output Mode)</b>				
1.0 to 33 mV	0.01 to 10 Hz	5.0 %	0.5 %	Two digits, e.g., 25 mV
34 to 330 mV				Three digits
0.4 to 3.3 V				Two digits
4 to 33 V				Two digits
0.3 to 3.3 V	10 to 500 kHz	(See AC Voltage (Sine Waves) Specifications)		
	500 kHz to 1 MHz	-8 dB at 1 MHz, typical		Two digits
	1 to 2 MHz	-32 dB at 2 MHz, typical		
<b>Auxiliary Output (Dual Output Mode)</b>				
10 to 330 mV	0.01 to 10 Hz	5.0 %	0.5 %	Three digits
0.4 to 3.3 V				Two digits
	10 to 10 kHz	(See AC Voltage (Sine Wave) Specifications)		

### 1-33. AC Voltage (Non-Sine Wave) Specifications

Triangle Wave & Truncated Sine Range p-p <sup>[1]</sup>	Frequency	1-Year Absolute Uncertainty, tcal ± 5 °C, ± (% of output + % of range) <sup>[2]</sup>		Maximum Voltage Resolution
		% Output	% Range	
<b>Normal Channel (Single Output Mode)</b>				
2.9 to 92.999 mV	0.01 to 10 Hz	5.0	0.5	Two digits on each range
93 to 929.999 mV	10 to 45 Hz	0.25	0.5	Six digits on each range
0.93 to 9.29999 V	45 Hz to 1 kHz	0.25	0.25	
9.3 to 92.9999 V	1 to 20 kHz	0.5	0.25	
	20 to 100 kHz <sup>[3]</sup>	5.0	0.5	
<b>Auxiliary Output (Dual Output Mode)</b>				
93 to 929.999 mV	0.01 to 10 Hz	5.0	0.5	Two digits on each range
	10 to 45 Hz	0.25	0.5	Six digits on each range
0.93 to 9.29999 V	45 Hz to 1 kHz	0.25	0.25	
	1 to 10 kHz	5.0	0.5	

[1] To convert p-p to rms for triangle wave, multiply the p-p value by 0.2886751. To convert p-p to rms for truncated sine wave, multiply the p-p value by 0.2165063.

[2] Uncertainty is stated in p-p. Amplitude is verified using an rms-responding DMM.

[3] Uncertainty for truncated sine outputs is typical over this frequency band.

Square Wave Range p-p <sup>[1]</sup>	Frequency	1-Year Absolute Uncertainty, tcal ± 5 °C, ± (% of output + % of range) <sup>[2]</sup>		Maximum Voltage Resolution
		% Output	% Range	
<b>Normal Channel (Single Output Mode)</b>				
2.9 to 65.999 mV	0.01 to 10 Hz	5.0	0.5	Two digits on each range
66 to 659.999 mV	10 to 45 Hz	0.25	0.5	Six digits on each range
0.66 to 6.59999 V	45 Hz to 1 kHz	0.25	0.25	
6.6 to 65.9999 V	1 to 20 kHz	0.5	0.25	
	20 to 100 kHz	5.0	0.5	
<b>Auxiliary Output (Dual Output Mode)</b>				
66 to 659.999 mV	0.01 to 10 Hz	5.0	0.5	Two digits on each range
	10 to 45 Hz	0.25	0.5	Six digits on each range
0.66 to 6.59999 V	45 Hz to 1 kHz	0.25	0.25	
	1 to 10 kHz	5.0	0.5	

[1] To convert p-p to rms for square wave, multiply the p-p value by .5000000.

[2] Uncertainty is stated in p-p. Amplitude is verified using an rms-responding DMM.



**1-34. AC Voltage, DC Offset Specifications**

Range <sup>[1]</sup> (Normal Channel)	Offset Range <sup>[2]</sup>	Max Peak Signal	1-Year Absolute Offset Uncertainty, tcal ± 5 °C <sup>[3]</sup> ± (% Output (dc) + μV)
<b>Sine Waves (rms)</b>			
3.3 to 32.999 mV	0 to 50 mV	80 mV	0.1 + 33
33 to 329.999 mV	0 to 500 mV	800 mV	0.1 + 330
0.33 to 3.29999 V	0 to 5 V	8 V	0.1 + 3300
3.3 to 32.9999 V	0 to 50 V	55 V	0.1 + 33 mV
<b>Triangle Waves and Truncated Sine Waves (p-p)</b>			
9.3 to 92.999 mV	0 to 50 mV	80 mV	0.1 + 93
93 to 929.999 mV	0 to 500 mV	800 mV	0.1 + 930
0.93 to 9.29999 V	0 to 5 V	8 V	0.1 + 9300
9.3 to 92.9999 V	0 to 50 V	55 V	0.1 + 93 mV
<b>Square Waves (p-p)</b>			
6.6 to 65.999 mV	0 to 50 mV	80 mV	0.1 + 66
66 to 659.999 mV	0 to 500 mV	800 mV	0.1 + 660
0.66 to 6.59999 V	0 to 5 V	8 V	0.1 + 6600
6.6 to 65.9999 V	0 to 50 V	55 V	0.1 + 66 mV
<p>[1] Offsets are not allowed on ranges above the highest range shown above.</p> <p>[2] The maximum offset value is determined by the difference between the peak value of the selected voltage output and the allowable maximum peak signal. For example, a 10 V p-p square wave output has a peak value of 5 V, allowing a maximum offset up to ± 50 V to not exceed the 55 V maximum peak signal. The maximum offset values shown above are for the minimum outputs in each range.</p> <p>[3] For frequencies 0.01 to 10 Hz, and 500 kHz to 2 MHz, the offset uncertainty is 5 % of output, ± 1 % of the offset range.</p>			

**1-35. AC Voltage, Square Wave Characteristics**

Rise Time @ 1 kHz Typical	Settling Time @ 1 kHz Typical	Overshoot @ 1 kHz Typical	Duty Cycle Range	Duty Cycle Uncertainty <sup>[1]</sup>
<1 μs	<10 μs to 1 % of final value	<2 %	1 % to 99 %, <3.3 V p-p, 0.01 Hz to 100 kHz	± (0.8 % of period +140 ns) for frequencies >10 kHz; + (0.8 % of period + 2 μs) for frequencies ≤10 kHz.
[1] For duty cycles of 10.00 % to 90.00 %.				

**1-36. AC Voltage, Triangle Wave Characteristics (typical)**

Linearity to 1 kHz	Aberrations
0.3 % of p-p value, from 10 % to 90 % point	<1 % of p-p value, with amplitude >50 % of range

**1-37. AC Current (Sine Wave) Extended Bandwidth Specifications**

Range	Frequency	1-Year Absolute Uncertainty, tcal ± 5 °C, ± (% of output + % of range)		Maximum Current Resolution
		% Output	% Range	
All current ranges, <330 mA	0.01 to 10 Hz	5.0	0.5	2 digits each range
	10 Hz to 10 kHz	(See AC Current (Sine Wave) Specifications)		

**1-38. AC Current (Non-Sinewave) Specifications**

Trianglewave & Truncated Sinewave Ranges <sup>[1]</sup>	Frequency	1-Year Absolute Uncertainty, tcal ± 5°C, ± (% of output + % of range) <sup>[2]</sup>		Maximum Current
		%Output	%Range	Resolution
2.9 to 92.999 mA	0.01 to 10 Hz	5.0	0.5	Two digits, e.g., 75 mA
	10 to 45 Hz	0.25	0.5	Six digits on each range
	45 to 1 kHz	0.25	0.25	
	1 to 10 kHz	5.0	0.5	
93 to 929.999 mA	0.01 to 10 Hz	5.0	0.5	Two digits
	10 to 45 Hz	0.25	0.5	Six digits on each range
	45 to 1 kHz	0.25	0.5	
	1 to 10 kHz	5.0	1.0	
0.93 to 6.19999 A	10 to 45 Hz	5.0	1.0	Two digits
	45 to 1 kHz	0.5	0.5	Six digits on each range
	1 to 5 kHz	5.0	1.0	
6.2 to 31 A	45 to 500 Hz	2.0	0.5	Two digits on each range
	500 to 1 kHz	5.0	1.0	Six digits on each range
<p>[1] All waveforms are peak-to-peak output ranges.</p> <p>[2] Uncertainty is stated in peak-to-peak. Amplitude is verified using an rms-responding DMM.</p>				

**1-39. AC Current (Non-Sine Wave) Specifications (cont)**

Squarewave Ranges <sup>[1]</sup>	Frequency	1-Year Absolute Uncertainty, $t_{cal} \pm 5^{\circ}C$ , $\pm$ (% of output + % of range) <sup>[2]</sup>		Maximum Current Resolution
		%Output	%Range	
2.9 to 65.999 mA	0.01 to 10 Hz	5.0	0.5	Two digits, e.g., 50 mA
	10 to 45 Hz	0.25	0.5	Six digits on each range
	45 to 1 kHz	0.25	0.25	
	1 to 10 kHz	5.0	0.5	
66 to 659.999 mA	0.01 to 10 Hz	5.0	0.5	Two digits
	10 to 45 Hz	0.25	0.5	Six digits on each range
	45 to 1 kHz	0.25	0.5	
	1 to 10 kHz	5.0	1.0	
0.66 to 4.39999 A	10 to 45 Hz	5.0	1.0	Two digits
	45 to 1 kHz	0.5	0.5	Six digits on each range
	1 to 5 kHz	5.0	1.0	
4.4 to 22 A	45 to 500 Hz	2.0	0.5	Two digits on each range
	500 to 1 kHz	5.0	1.0	Six digits on each range

[1] All waveforms are peak-to-peak output ranges.  
 [2] Uncertainty is stated in peak-to-peak. Amplitude is verified using an rms-responding DMM.

**1-40. AC Current, Square Wave Characteristics (typical)**

Range	Rise Time	Settling Time	Overshoot
I < 4.4 A @ 400 Hz	25 $\mu$ s	40 $\mu$ s to 1 % of final value	<10 % for loads <100 $\Omega$

**1-41. AC Current, Triangle Wave Characteristics (typical)**

Linearity to 400 Hz	Aberrations
0.3 % of p-p value, from 10 % to 90 % point	<1 % of p-p value, with amplitude >50 % of range



# Chapter 2

## Preparing for Operation

	<b>Contents</b>	<b>Page</b>
2-1.	Introduction.....	2-3
2-2.	Unpacking and Inspection .....	2-3
2-3.	Replacing The Fuse .....	2-3
2-4.	Selecting Line Voltage .....	2-4
2-5.	Connecting To Line Power.....	2-4
2-6.	Service Information .....	2-6
2-7.	Placement and Rack Mounting.....	2-7
2-8.	Cooling Considerations .....	2-7
2-9.	Connecting the 5725A Amplifier .....	2-7





**Warning**  
The 5500A Calibrator can supply lethal voltages. Read this section before operating the calibrator.

## 2-1. Introduction

This chapter provides instructions for unpacking and installing the 5500A, selecting the line voltage, replacing the fuse, and connecting to line power. Instructions for cable connections other than line power can be found in the following chapters:

- UUT (Unit Under Test) connections: Chapter 4, “Front Panel Operation”
- IEEE-488 parallel interface connection: Chapter 5, “Remote Operation”
- RS-232C serial interface connection: Chapter 5, “Remote Operation”
- Auxiliary amplifier connections: Chapter 4, “Front Panel Operation”

## 2-2. Unpacking and Inspection

The calibrator is shipped in a container designed to prevent damage during shipping. Inspect the calibrator carefully for damage and immediately report any damage to the shipper. Instructions for inspection and claims are included in the shipping container.

When you unpack the calibrator, check for all the standard equipment listed in Table 2-1 and check the shipping order for any additional items ordered. Refer to Chapter 9, “Accessories” for more information. Report any shortage to the place of purchase or to the nearest Fluke Technical Service Center (see “Service Information” in this section). A performance test is provided in Chapter 7, “Maintenance.”

If reshipping the calibrator, use the original container. If it is not available, you can order a new container from Fluke by indicating the calibrator's model and serial number.

**Table 2-1. Standard Equipment**

Item	Model or Part Number
Calibrator	5500A
Line Power Cord	See Table 2-2 and Figure 2-2
5500A Getting Started Manual	945159
5500A Operator Reference Guide	945097
5500A Remote Programming Reference Guide	105783
CD-ROM (contains Operator and Service Manuals)	1627768
Certificate of Calibration	Form G749

## 2-3. Replacing The Fuse

### Caution

**To prevent possible damage to the instrument, verify the correct fuse is installed for the selected line voltage setting (100 V and 120 V, use 2.5 A/250 V time delay; 200 V and 240 V, use 1.25 A/250 V time delay).**

The line power fuse is accessible on the rear panel. The fuse rating is 2.5 A/250 V time delay fuse for the 100 V/120 V line voltage setting; 1.25 A/250 V time delay fuse for the 220 V/240 V line voltage setting. Fuses that are not user replaceable are discussed in Chapter 7, “Maintenance.”

To check or replace the fuse, refer to Figure 2-1 and proceed as follows:

1. Disconnect line power.
2. Open the fuse compartment by inserting a screwdriver blade in the tab located at the left side of the compartment and gently pry until it can be removed with the fingers.
3. Remove the fuse from the compartment for replacement or verification. Be sure the correct fuse is installed.
4. Reinstall the fuse compartment by pushing it back into place until the tab locks.

## 2-4. **Selecting Line Voltage**

The calibrator arrives from the factory configured for the line voltage normally appropriate for the country of purchase, or as specified at the time of your purchase order. You can operate the 5500A Calibrator from one of four line voltage settings: 100 V, 120 V, 200 V, and 240 V (47 to 63 Hz). To check the line voltage setting, note the voltage setting visible through the window in the power line fuse compartment cover (Figure 2-1). The allowed line voltage variation is 10% above or below the line voltage setting.

To change the line voltage setting, complete the following procedure:

1. Remove the fuse compartment by following the first two steps in “Replacing the Fuse” earlier in this chapter.
2. Remove the line voltage selector assembly by gripping the line voltage indicator tab with pliers and pulling it straight out of its connector.
3. Rotate the line voltage selector assembly to the desired voltage and reinsert.
4. Verify the appropriate fuse for the selected line voltage (100 V/120 V, use 2.5 A/250 V time delay; 220 V/240 V, use 1.25 A/250 V time delay) and reinstall the fuse compartment by pushing it back into place until the tab locks.

## 2-5. **Connecting To Line Power**

### **Warning**

**To avoid shock hazard, connect the factory supplied three-conductor line power cord to a properly grounded power outlet. Do not use a two-conductor adapter or extension cord; this will break the protective ground connection.**

**Use the rear-panel ground terminal for a protective grounding wire if there is any question as to instrument earth grounding.**

The calibrator is shipped with the appropriate line power plug for the country of purchase. If you need a different type, refer to Table 2-2 and Figure 2-2 for a list and illustration of the line power plug types available from Fluke.

After you verify that the line voltage selection is set correctly and that the correct fuse for that line voltage is installed, connect the calibrator to a properly grounded three-prong outlet.



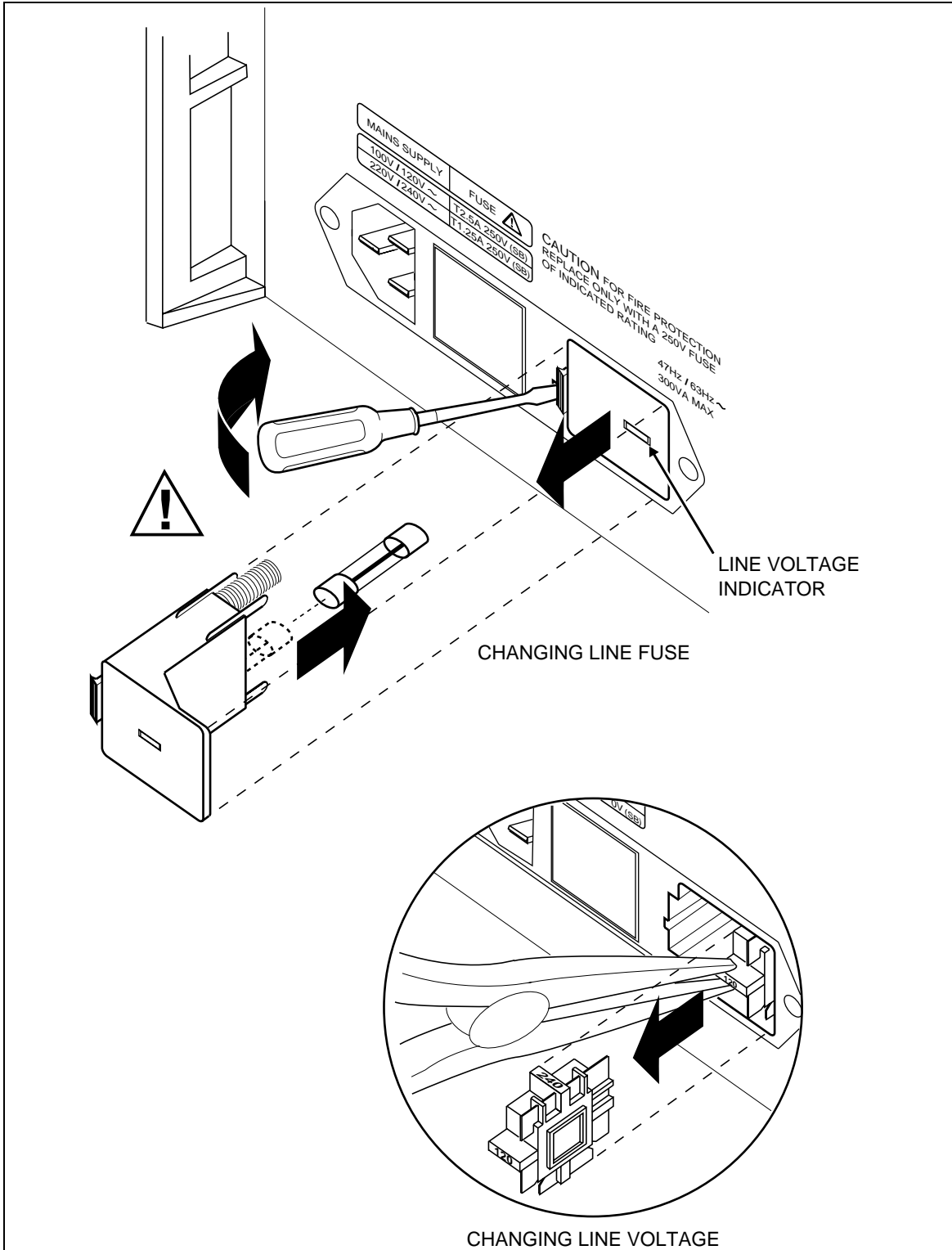

F2-01.eps

Figure 2-1. Accessing the Fuse and Selecting Line Voltage

**Table 2-2. Line Power Cord Types Available from Fluke**

Type	Voltage/Current	Fluke Option Number
North America	120 V/15 A	LC-1
North America	240 V/15 A	LC-2
Universal Euro	220 V/16 A	LC-3
United Kingdom	240 V/13 A	LC-4
Switzerland	220 V/10 A	LC-5
Australia	240 V/10 A	LC-6
South Africa	240 V/5 A	LC-7

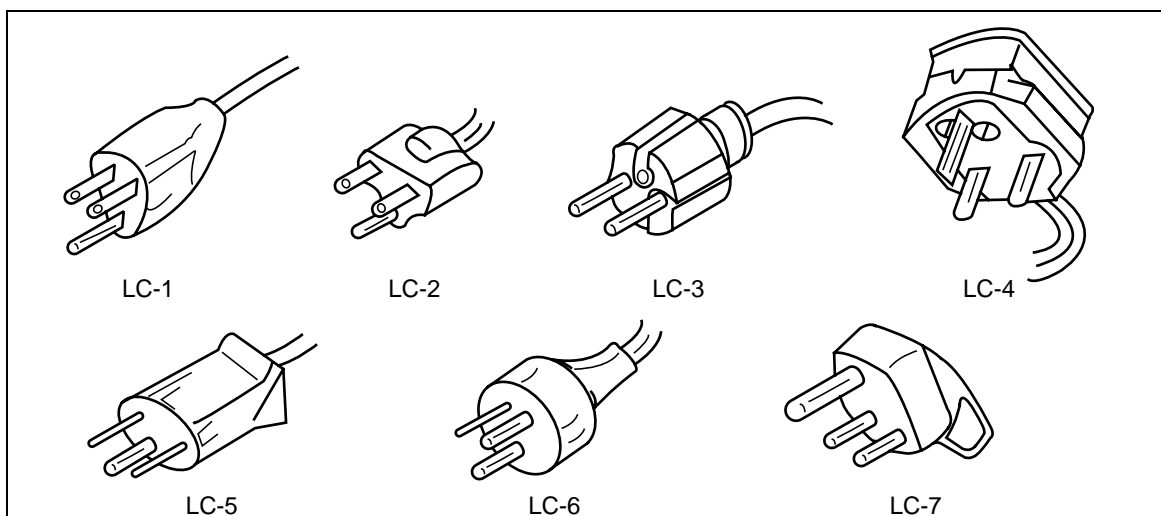

F2-02.eps

**Figure 2-2. Line Power Cord Types Available from Fluke**

## **2-6. Service Information**

Each Model 5500A Calibrator is warranted to the original purchaser for a period of 1 year beginning on the date received. The warranty is located at the front of this manual.

To locate an authorized service center, call Fluke using any of the phone numbers listed below, or visit us on the World Wide Web: [www.fluke.com](http://www.fluke.com)

USA: 1-888-99-FLUKE (1-888-993-5853)

Canada: 1-800-36-FLUKE (1-800-363-5853)

Europe: +31 402-675-200

Japan: +81-3-3434-0181

Singapore: +65-738-5655

Anywhere in the world: +1-425-446-5500

After-warranty service is available, but you may choose to repair the calibrator using the information in the Troubleshooting Section of the 5500A Service Manual and the Module Exchange Program. Refer to the Fluke catalog or contact a Technical Service Center representative for the module exchange procedure.

## **2-7. Placement and Rack Mounting**

You may place the calibrator on a bench top or mount it in a standard-width, 24-inch (61-cm) deep equipment rack. For bench-top use, the calibrator is equipped with non-slipping, non-marring feet. To mount the calibrator in an equipment rack, use the 5500A Rack Mount Kit, Model Y5537. Instructions for rack mounting the calibrator are packed with the rack mount kit.

## **2-8. Cooling Considerations**

### **Warning**

**To avoid risk of injury, never operate or power the 5500A Calibrator without the fan filter in place.**

### **Caution**

**Damage caused by overheating may occur if the area around the air intake is restricted, the intake air is too warm, or the air filter becomes clogged.**

Baffles direct cooling air from the fan throughout the chassis to internally dissipate heat during operation. The accuracy and dependability of all internal parts of the calibrator are enhanced by maintaining the coolest possible internal temperature. You can lengthen the life of the calibrator and enhance its performance by observing the following rules:

- The area around the air filter must be at least 3 inches from nearby walls or rack enclosures.
- The exhaust perforations on the sides of the calibrator must be clear of obstructions.
- The air entering the instrument must be at room temperature: make sure the exhaust air from another instrument is not directed into the fan inlet.
- Clean the air filter every 30 days or more frequently if the calibrator is operated in a dusty environment. (See Chapter 7, “Maintenance” for instructions on cleaning the air filter.)

## **2-9. Connecting the 5725A Amplifier**

The 5500A provides an interface connection for the Fluke 5725A Amplifier. You designate whether the 5500A or 5725A is the preferred source of current and voltage in a calibrator setup menu (see Chapter 4, “Front Panel Operation”). A single connection cable provides the complete link for analog and digital control signals. Refer to the 5725A Instruction Manual for installation instructions.



# Chapter 3 Features

	<b>Contents</b>	<b>Page</b>
3-1.	Introduction.....	3-3
3-2.	Front Panel Features .....	3-3
3-3.	Rear Panel Features .....	3-3
3-4.	Softkey Menu Trees.....	3-3



### **3-1. Introduction**

This chapter is a reference for the functions and locations of the 5500A Calibrator's front and rear panel features. Please read this information before operating the calibrator. Front panel operating instructions for the calibrator are provided in Chapter 4, "Front Panel Operation"; remote operating instructions are provided in Chapter 5, "Remote Operation."

### **3-2. Front Panel Features**

Front panel features (including all controls, displays, indicators, and terminals) are shown in Figure 3-1. Each front panel feature is described in Table 3-1.

### **3-3. Rear Panel Features**

Rear panel features (including all terminals, sockets, and connectors) are shown in Figure 3-2. Each rear panel feature is described in Table 3-2.

### **3-4. Softkey Menu Trees**

The Setup softkeys are identified in Figures 3-3 and 3-4. The Setup softkeys are associated with the 5500A Calibrator front panel **SETUP** key. The functions of the five softkeys are identified by label information displayed directly above each key. The softkey labels change during operation so that many different functions are quickly accessible.

A group of softkey labels is called a menu. A group of interconnected menus is called a menu tree. Figure 3-3 shows the SETUP menu tree structure; Figure 3-4 describes each SETUP menu tree display. Table 3-3 shows the factory default settings for the SETUP menu tree. To return the SETUP menus to their default values, use the softkey SETUP in the Format NV Memory menu (see Figure 3-4, menu F).

Figure 3-5 shows the MEAS TC menu tree structure; Figure 3-6 describes each MEAS TC menu tree display.

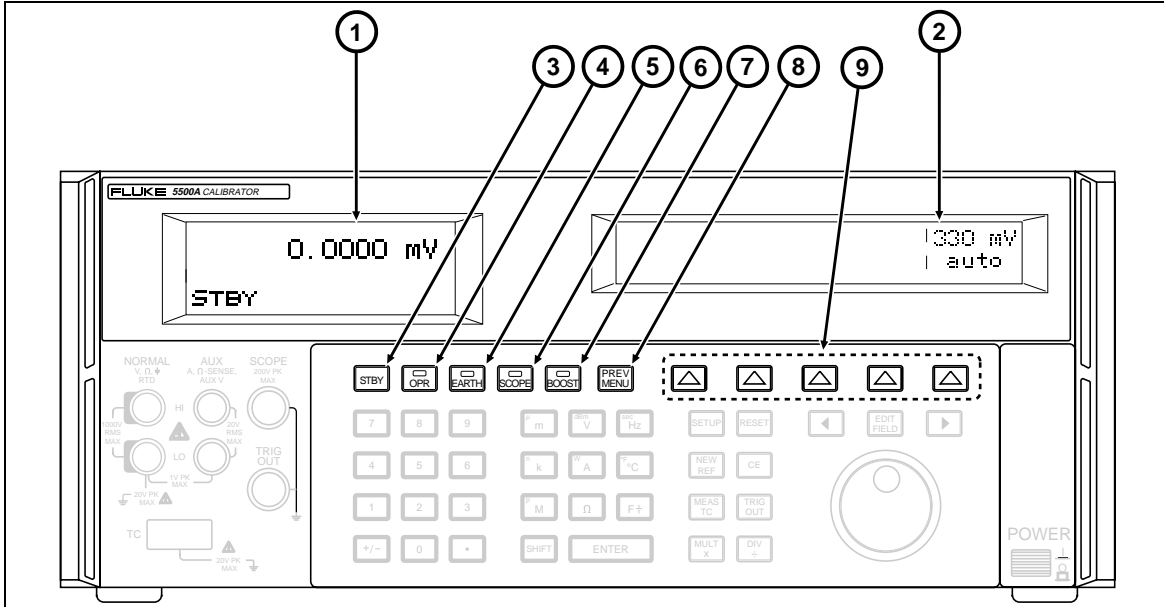

F3-01b.eps

Figure 3-1. Front Panel View

Table 3-1. Front Panel Features

**1 Output Display**

The Output Display is a two-line backlit LCD that shows output amplitudes, frequency and calibrator status. Output values (or potential output values if in standby) are displayed using up to seven digits plus a polarity sign. Output frequencies (or potential output frequencies if the 5500A is in standby) are displayed using four digits. Calibrator status is indicated by displaying the following abbreviations:

OPR	Displayed when an output is active at the front panel terminals or auxiliary amplifier terminals.
STBY	Displayed when the 5500A is in standby.
ADDR	Displayed when the 5500A is addressed over the IEEE-488 interface.
u	When you change the output, a “u” (unsettled) is displayed for a second or two until the output settles to within the specified accuracy.
m	Displayed when the calibrator is making a measurement. (Thermocouple measurement feature only.)
?	Displayed when the amplitude is specified as typical only, and/or reduced resolution. This occurs when operating the 5500A in the extended bandwidth mode.

**2 Control Display**

The Control Display is a multipurpose backlit LCD used for displaying data entries, UUT error adjustments, softkey labels, phase angles, watts, power factors, and other prompts and messages. When there isn't enough room on the Output Display, output frequency is displayed on the Control Display. Softkey labels identify the function of the softkey directly below them. Several softkey labels together are called a menu. The changing menus provide access to many different functions through the five softkeys plus the PREV MENU key. (See Figure 3-3, Softkey Menu Tree.)



- 3** **STBY**
- The **STBY** (Standby) key places the 5500A in the standby mode. Standby mode is indicated by “STBY” in the lower left corner of the output display. In standby mode, the NORMAL and AUX output terminals are internally disconnected from the 5500A. The 5500A normally starts up in the standby mode. The 5500A automatically switches to standby if one of the following occurs:
- The RESET key is pressed.
  - A voltage  $\geq 33$  V is selected when the previous output voltage was less than 33 V.
  - Output function is changed, except when going between ac or dc voltage  $<33$  V.
  - Output location is changed.
  - An overload condition is detected.
- 4** **OPR**
- The **OPR** (Operate) key places the 5500A in the operate mode. The operate mode is indicated by “OPR” in the lower left corner of the output display and the lit indicator on the OPR key.
- 5** **EARTH**
- The **EARTH** (Earth Ground) key opens and closes an internal connection between the NORMAL LO terminal and earth ground. An annunciator on the key indicates when this connection is made. The power-up default condition is earth disabled (annunciator off).
- 6** **SCOPE**
- The **SCOPE** (Oscilloscope) key enables or disables the ScopeCal option if it is present. An annunciator on the key indicates when the option is enabled. If the ScopeCal option is not installed in the calibrator and the Scope key is pressed, the calibrator will beep with no change in the calibrator’s status.
- 7** **BOOST**
- The **BOOST** (5725A Amplifier Boost) key enables or disables output from an amplifier, when it would not otherwise be automatically selected. The BOOST key sets the 5500A to standby if this selection moves the output location. An annunciator on the key indicates when the 5725A is being used.
- When available, an amplifier is automatically selected for output settings that exceed 5500A capabilities but fall within the limits of the selected amplifier. The BOOST key is only needed to activate an amplifier for an output setting that is available from either the 5500A or the amplifier. This allows you to take advantage of amplifier capabilities in addition to extended range, such as higher compliance voltage.
- 8** **PREV MENU**
- The **PREV MENU** (Previous Menu) key recalls the previous set of menu choices. Each press of this key backs up one level of the menu tree until the display indicates the top level menu selection of the function selected.
- 9** **Softkeys**
- The functions of the five unlabeled blue softkeys are identified by labels on the Control Display directly above each key. The functions change during operation so that many different functions are accessible through these keys. A group of softkey labels is called a menu. A group of interconnected menus is called a menu tree.

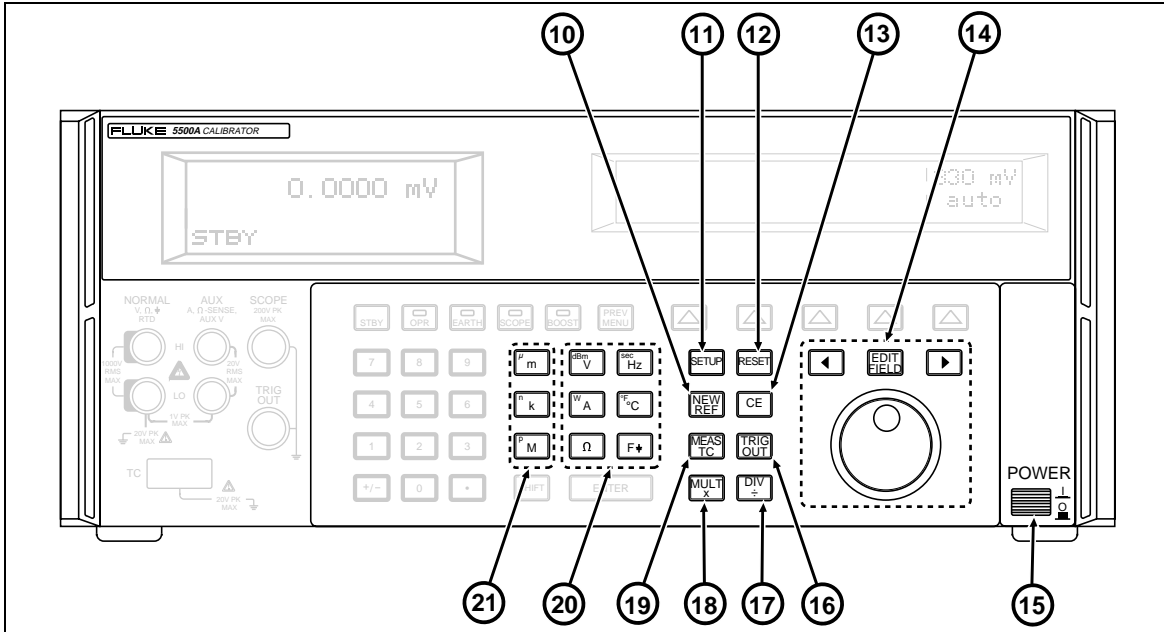



F3-01c.eps

Figure 3-1. Front Panel View (cont)

Table 3-1. Front Panel Features (cont)

10	NEW REF	The <b>NEW REF</b> (New Reference) key is active during error mode operation, and establishes the present output value as a new reference for meter error computation.
11	SETUP	The <b>SETUP</b> (Setup Menu) key puts the 5500A in the setup mode, displaying the setup menu in the control display. Setup options can be selected using the softkeys under the control display.
12	RESET	The <b>RESET</b> (Reset Calibrator) key aborts the current operating state of the 5500A and returns it to the power-up default state, except when operating under remote control.
13	CE	The <b>CE</b> (Clear Entry) key clears a partially completed keypad entry from the Control Display. If there is a partially completed entry when CE is pressed, the output is unaffected.
14	EDIT FIELD	The <b>EDIT FIELD</b> (Edit Output Display Field) key and associated left/right arrow keys provide step adjustment of the output signals. If any of these keys are pressed or the knob is rotated, a digit on the Output Display becomes highlighted and the output increments or decrements as the knob is rotated. If a digit rolls past 0 or 9, the digit to its left or right is carried. An error display appears on the Control Display, showing the difference between the original (reference) output and the new output.

The  and  keys adjust the magnitude of changes by moving the highlighted digit. The  key allows you to move from voltage or current to frequency and back. In practice, for voltage and current outputs, the knob and arrow keys are used to adjust output until the UUT reads correctly. The error display then displays UUT deviation from the reference.

- 15** The **POWER** (Primary Power) switch turns the power on and off. The switch is a latching push-push type. When the switch is latched, power is applied.

- 16**  The **TRIG OUT** (Trigger Out) key sets the external trigger when in the Scope mode. If the 5500A is not in the scope mode when the Trigger Out key is pressed, the beeper will sound.







- 17**  The **DIV** (Divide) key immediately changes the output to one tenth the reference value (not necessarily the present output value) if the value is within performance limits. In the SCOPE mode, the DIV key changes the output to the next lower range.

- 18**  The **MULT** (Multiply) key immediately changes the output to ten times the reference value (not necessarily the present output value) if the value is within performance limits. This key sets the 5500A to standby if this change is from below 33 V. In the SCOPE mode, the MULT key changes the output to the next higher range.

- 19**  The **MEAS TC** (Measure Thermocouple) key enables the TC (Thermocouple) input connection and causes the 5500A to compute a temperature based on the voltage present at the input.

**20** **Output Units Keys**



The output units keys determine the function of the 5500A. Some keys have a second unit if the SHIFT key is pressed just before the units key. The output units are as follows:

-  Voltage or Decibels relative to 1 mW into 600 ohms.
-  Watts or Current
-  Resistance
-  Frequency or Seconds (Seconds is applicable to the SCOPE functions only)
-  Capacitance
-  Temperature in Fahrenheit or Centigrade

When a frequency (Hz) value is entered, the 5500A automatically switches to ac. When a new signed (+ or -) output value is entered without specifying Hz, the 5500A automatically switches back to dc (or enter "0" Hz to move back to volts dc).

**21** **Multiplier Keys**

Select output value multipliers. Some keys have a second function if the SHIFT key is pressed just before the multiplier key. For example, if you enter 33, then SHIFT, then <sup>μ</sup>m, then F, then ENTER, the 5500A output value is 33 pF. The multiplier keys are as follows:

-  milli (10<sup>-3</sup> or 0.001) or micro (10<sup>-6</sup> or 0.000001)
-  kilo (10<sup>3</sup> or 1,000) or nano (10<sup>-9</sup> or 0.000000001)
-  mega (10<sup>6</sup> or 1,000,000) or pico (10<sup>-12</sup> or 0.000000000001)

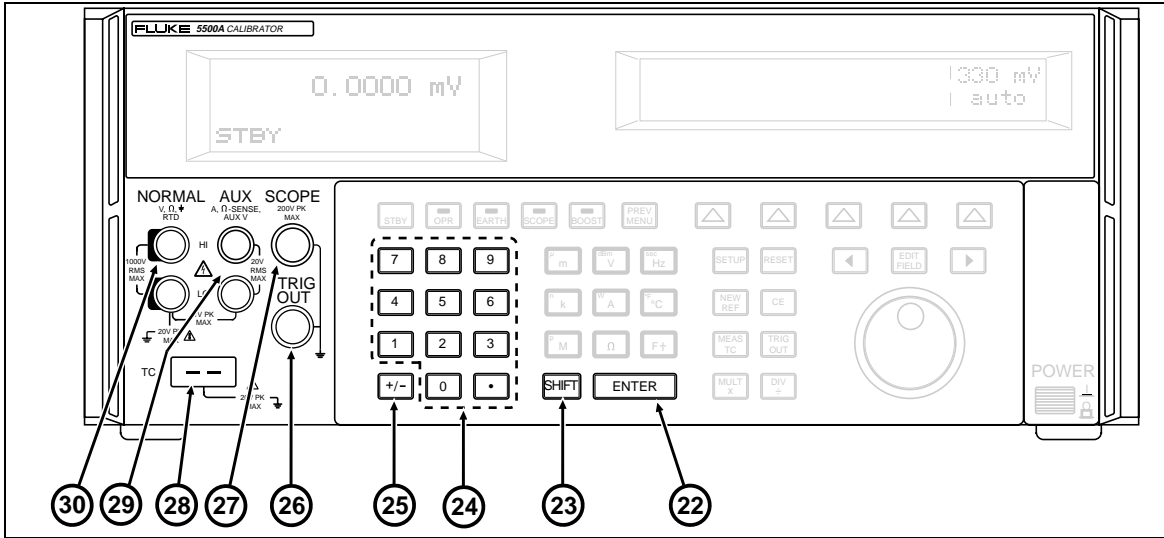

F3-01c.eps

Figure 3-1. Front Panel View (cont)

Table 3-1. Front Panel Features (cont)

<p><b>22</b></p>	<p><b>ENTER</b></p> <p>The <b>ENTER</b> (Enter Value) key loads a newly entered output value shown on the Control Display into the 5500A, which appears on the Output Display. The new value can come from the numeric keypad. If you press ENTER without identifying the units for the entry, in most cases the 5500A keeps the units that were last used. This allows you, for example, to enter 1 mV, and then later enter 10 to obtain 10 V. (The "V" units were saved from the last entry, but not the multiplier, "m".) In the Error (edit) mode, ENTER with no value restores the output to the value of the reference.</p>
<p><b>23</b></p>	<p><b>SHIFT</b></p> <p>The <b>SHIFT</b> (Shift Key Function) is used to select alternate functions of the units keys and alternate multipliers of the multiplier keys. These alternate selections are labeled with small letters in the upper left hand corner of the keys.</p>
<p><b>24</b></p>	<p><b>Numeric Keypad</b></p> <p>Used to enter the digits of the output amplitude and frequency. The proper sequence to enter a value is to press the digits of the output value, a multiplier key (if necessary), an output units key, then ENTER. For example, to obtain an output of 20 mV, you would press the following sequence of keys: <b>2</b> <b>0</b> <b>μ</b> <b>m</b> <b>dBm</b> <b>V</b> <b>ENTER</b>. Press <b>OPR</b> to enable the output. Pressing a digit key once the entry field is full, and pressing the decimal point key more than once in a single number will sound the beeper.</p>

- 25** +/-

The **+/-** (Polarity) key changes the polarity of the output for dc voltage or dc current functions. Press the **+/-** key then ENTER to toggle the output polarity.
- 26**

The **TRIG OUT** (Trigger Output) BNC connector is used to trigger the oscilloscope during oscilloscope calibration. This is active only when the ScopeCal option is installed.
- 27**

The **SCOPE** (Oscilloscope) connector is used for outputs during oscilloscope calibration. This is active only when the ScopeCal option is installed.
- 28**

The **TC** (Thermocouple) connector is used for thermocouple simulation during temperature meter calibration, and thermocouple measurements. You must use the correct thermocouple wire and plug when using this connector. For example, if simulating a K thermocouple, use K-type thermocouple wire and K-type plug for making connections.
- 29**

The **AUX** (Auxiliary Output) jacks are used for ac and dc current outputs, the second voltage output in dual voltage modes, and ohms sense for 2-wire and 4-wire compensated resistance and capacitance measurements, and RTD simulation.
- 30**

The **NORMAL** (Normal Output) jacks are used for ac and dc voltage, ohms and capacitance sourcing, and Resistance Temperature Detector (RTD) simulation.

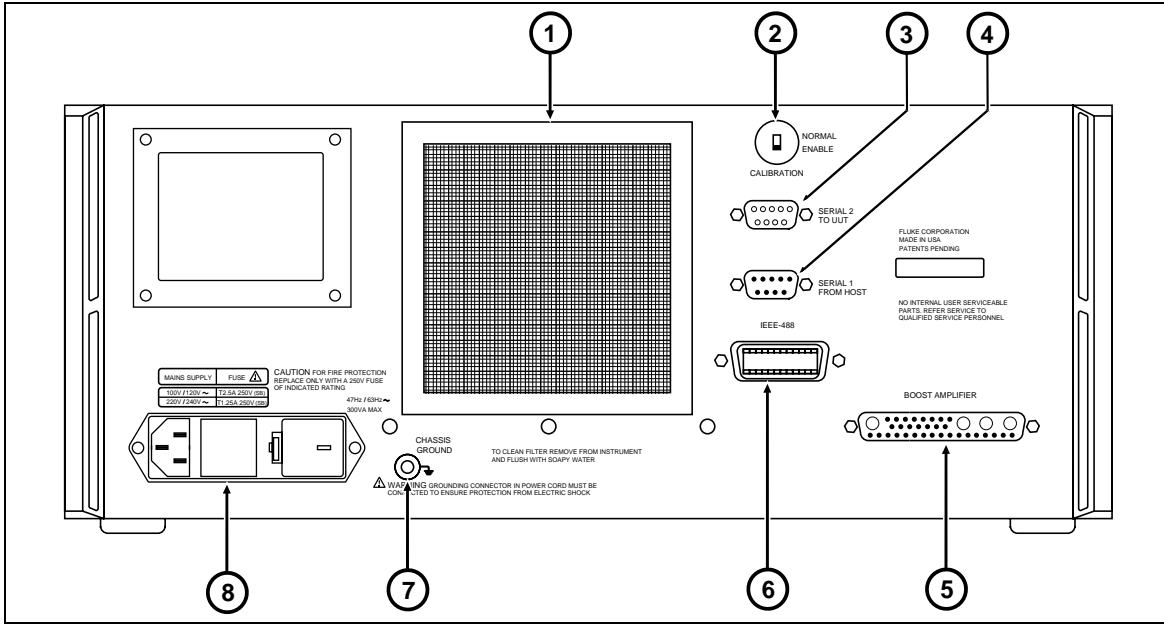

Figure 3-2. Rear Panel View

F3-02.eps

Table 3-2. Rear Panel Features

- ① The **Fan Filter** covers the air intake to keep dust and debris out of the chassis air baffles. The 5500A fan provides a constant cooling air flow throughout the chassis. Fan filter maintenance is described in Section 7, Maintenance.
- ② The **CALIBRATION NORMAL/ENABLE** slide switch is used to write enable and disable the nonvolatile memory that stores calibration constants. Switching to ENABLE allows changes to be written into memory, and switching to NORMAL protects data in memory from being overwritten. The switch is recessed to allow it to be covered with a calibration sticker to guarantee calibration integrity.
- ③ The **SERIAL 2 TO UUT** connector is used for transmitting and receiving RS-232 serial data between the 5500A and an RS-232 port on a Unit Under Test (UUT). Chapter 6, “Remote Commands” describes how to use the RS-232 serial interface for UUT communications.
- ④ The **SERIAL 1 FROM HOST** connector is used for remote control of the 5500A and for transmitting internal-constant RS-232 serial data to a printer, monitor, or host computer. Chapter 5, “Remote Operation” describes how to use the RS-232 serial interface for remote control.
- ⑤ The **BOOST AMPLIFIER** connector provides the analog and digital interface for the Fluke 5725A Amplifier. After connecting the 5725A to the connector, you control the 5725A from the 5500A front panel or by remote commands. Refer to “Using an Auxiliary Amplifier” in Chapter 4, “Front Panel Operation” for details.

⑥ The **IEEE-488** connector is a standard parallel interface for operating the 5500A in remote control as a Talker/Listener on the IEEE-488 bus. Refer to Chapter 5, “Remote Operation” for bus connection and remote programming instructions.

⑦



**To avoid shock hazard, connect the factory supplied three-conductor line power cord to a properly grounded power outlet. Do not use a two-conductor adapter or extension cord; this will break the protective ground connection.**

**Use the rear-panel ground terminal for a protective grounding wire if there is any question as to instrument earth grounding.**

The **CHASSIS GROUND** binding post is internally grounded to the chassis. If the 5500A is the location of the ground reference point in a system, this binding post can be used for connecting other instruments to earth ground. Refer to “Connecting the Calibrator to a UUT” in Chapter 4, “Front Panel Operation” for details.

⑧

The **AC Power Input Module** provides a grounded three-prong connector that accepts the line power cord, a switch mechanism to select the operating line voltage, and a line power fuse. See Chapter 2, “Preparing for Operation” for information on selecting the operating line voltage, and fuse rating and replacement information.

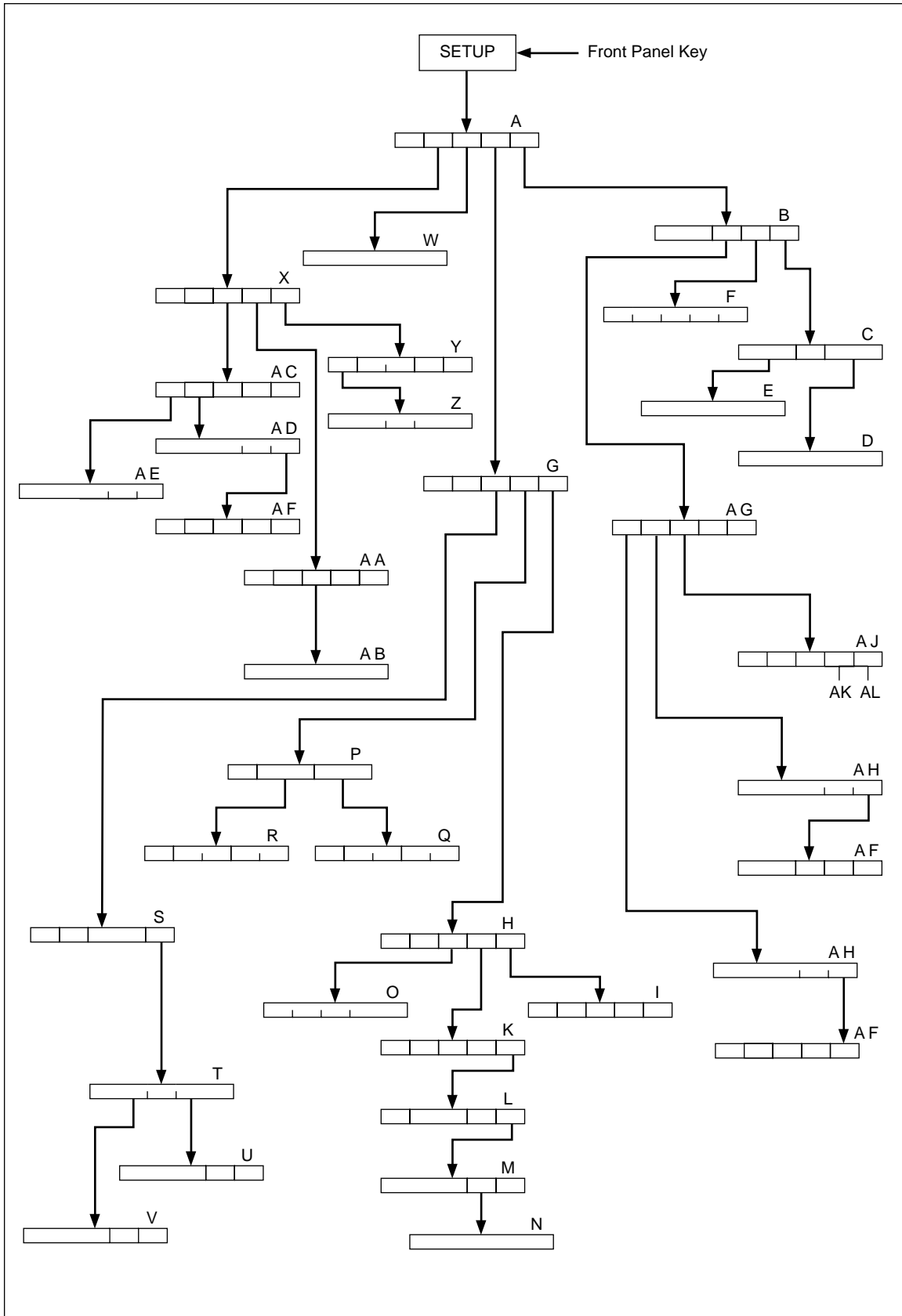
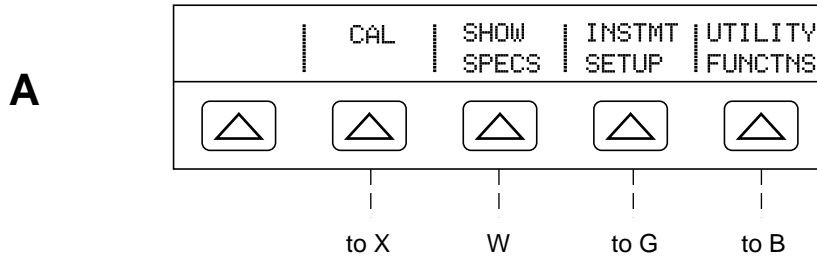

Figure 3-3. SETUP Softkey Menu Tree

F3-03.eps





SHOW SPECS is an online summary of the programmed output specifications.

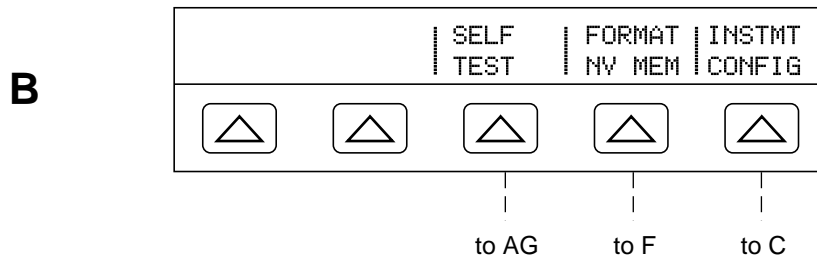

If self test does not pass, error codes are displayed. (See chapter 7, "Maintenance")

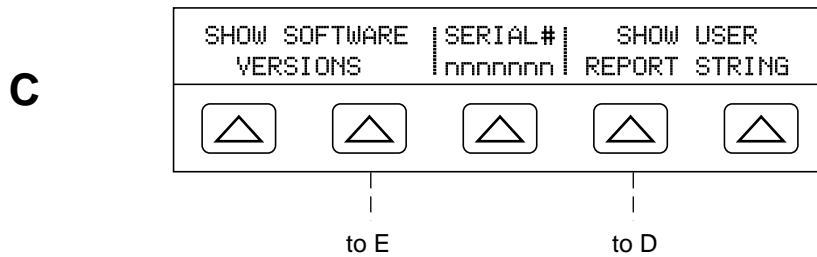

SERIAL # displays the serial number of the instrument. When corresponding with the factory, always include the serial number of the instrument.

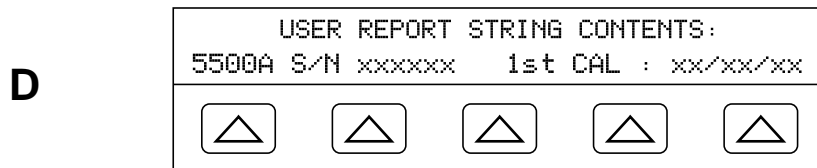

USER REPORT STRING CONTENTS refer to a string of characters entered by the user for reporting purposes.

Figure 3-4. SETUP Softkey Menu Displays

F3-04a.eps

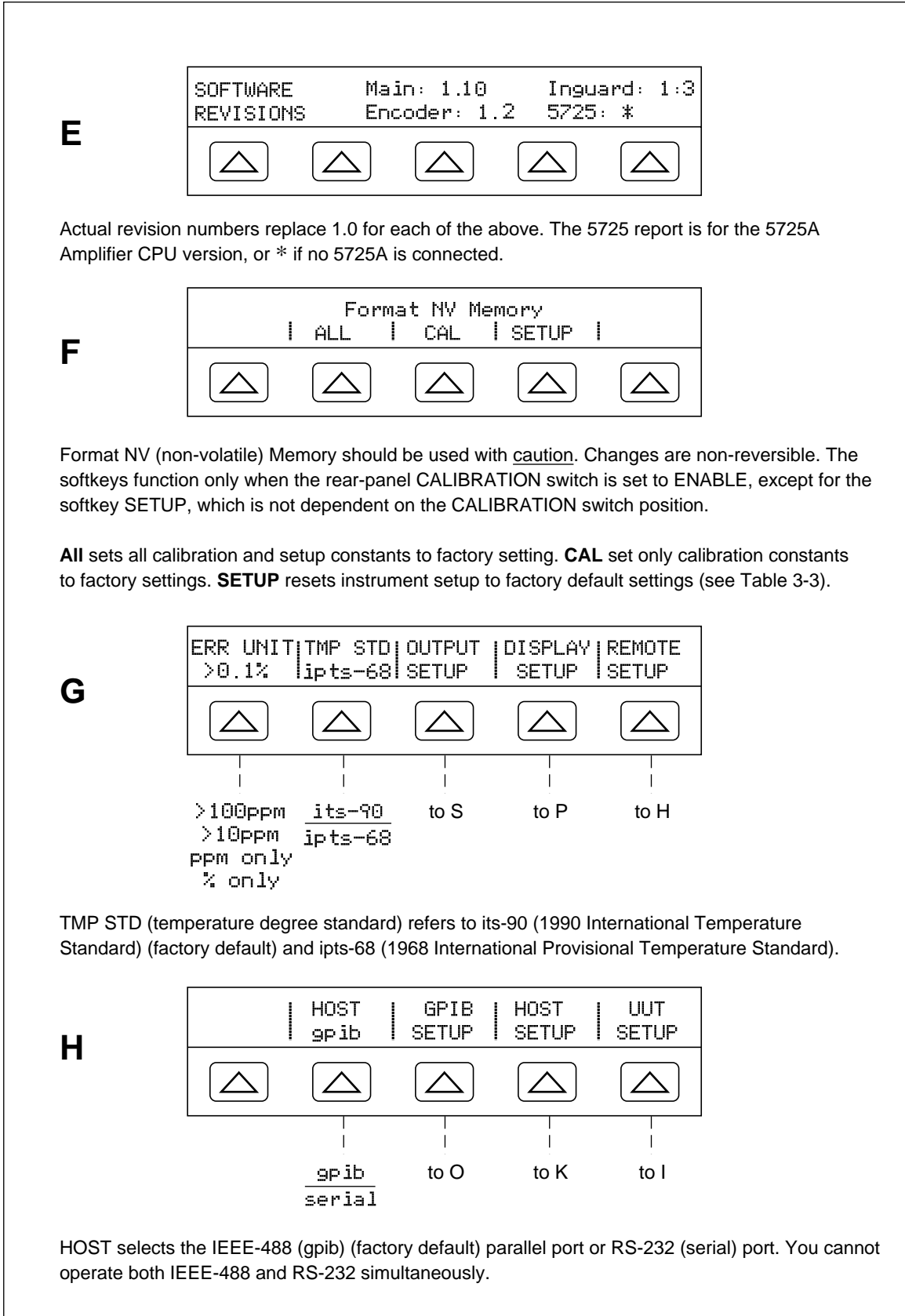

Figure 3-4. SETUP Softkey Menu Displays (cont)

F3-04b.eps

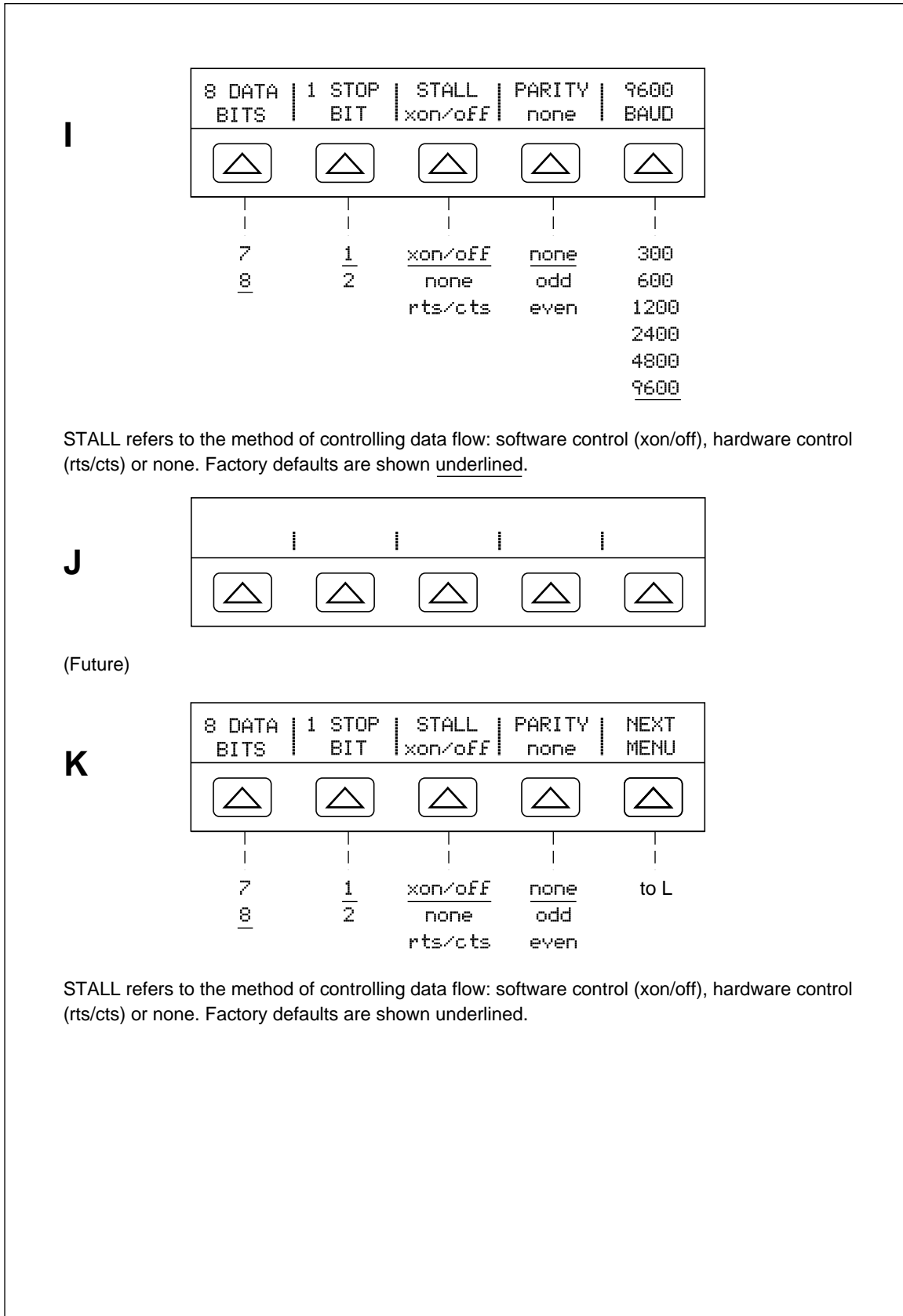

Figure 3-4. SETUP Softkey Menu Displays (cont)

F3-04c.eps

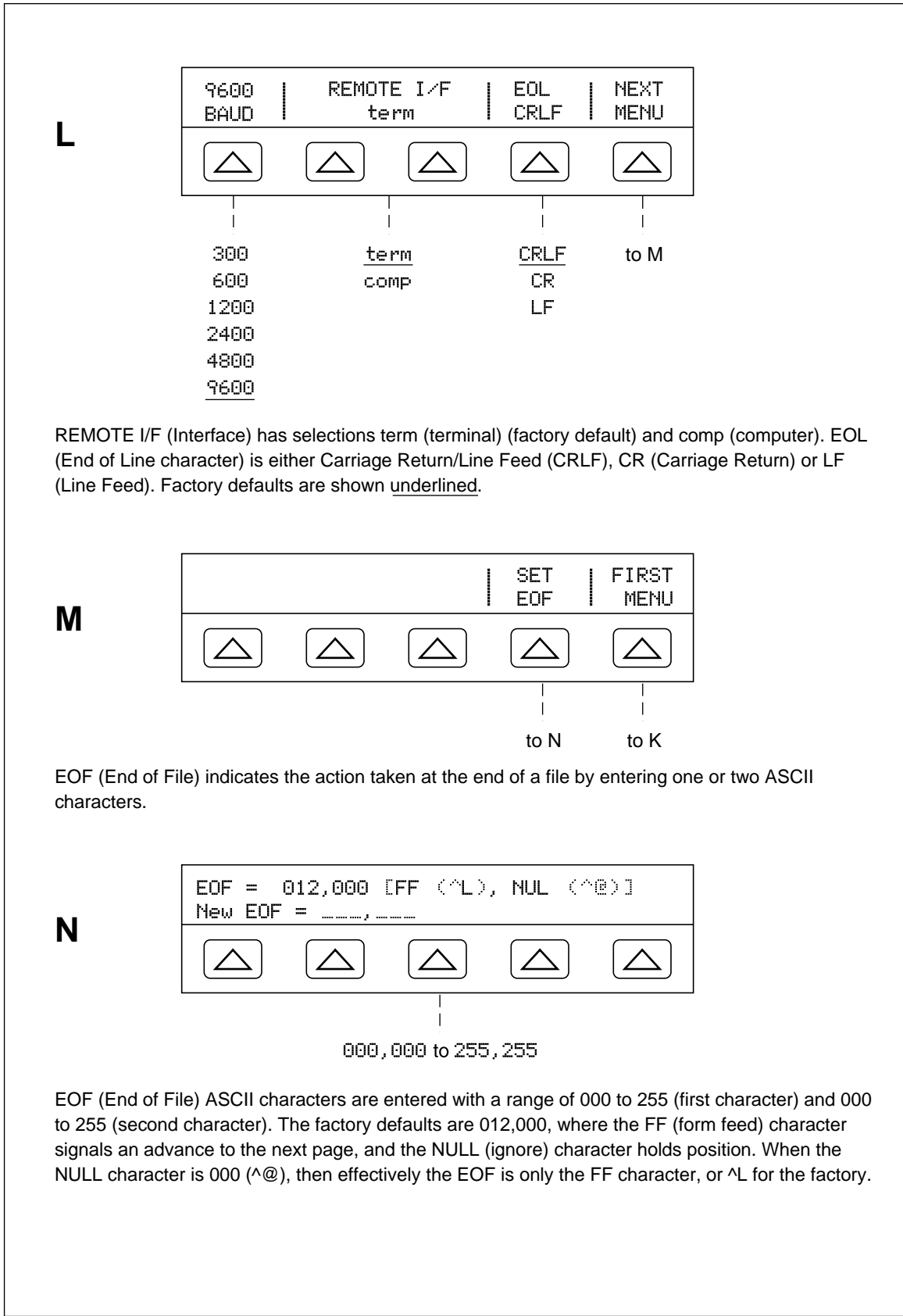

Figure 3-4. SETUP Softkey Menu Displays (cont)

F3-04d.eps

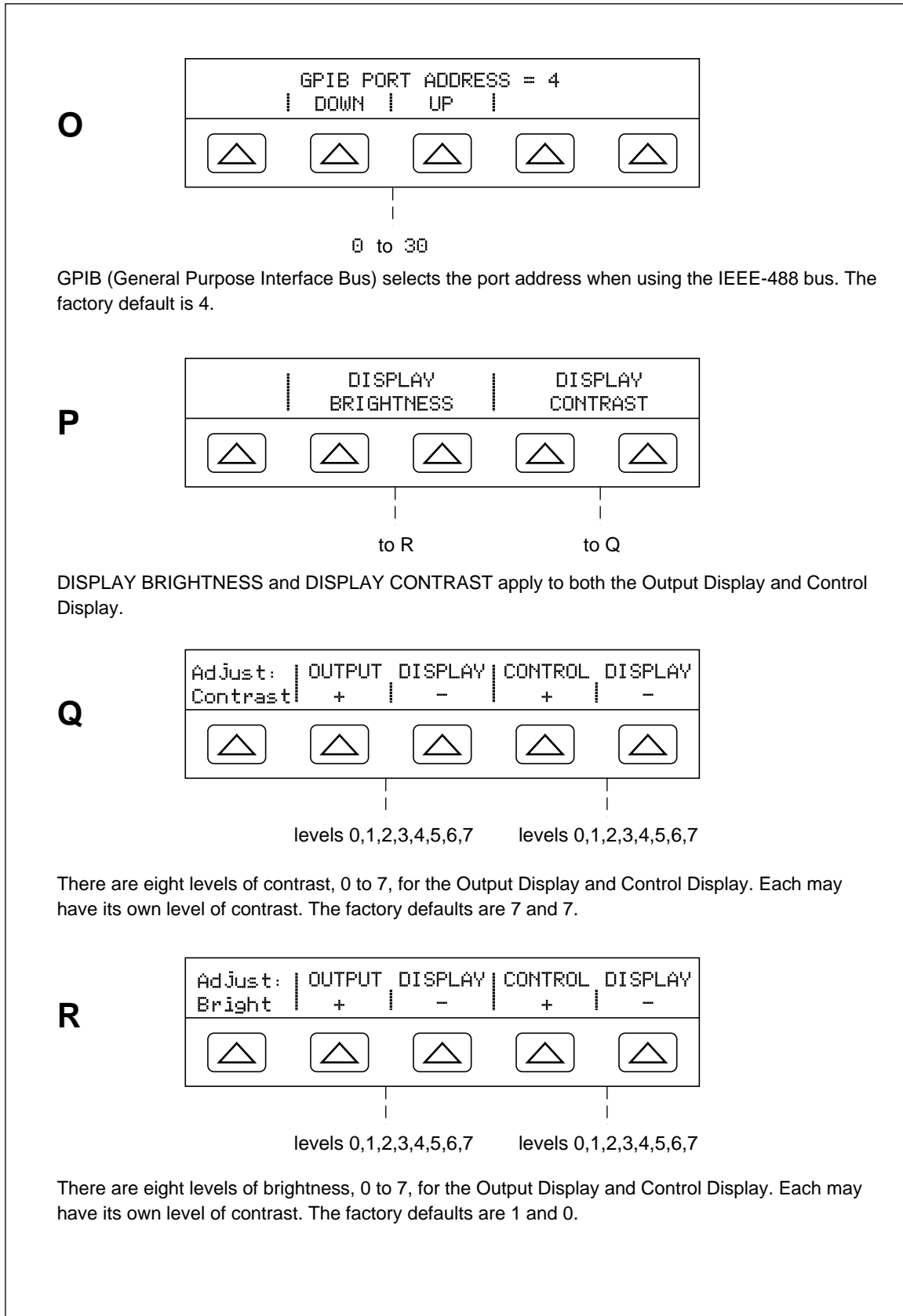



Figure 3-4. SETUP Softkey Menu Displays (cont)

F3-04e.eps

S

RTD TYPE	TC TYPE	SOURCE PREFERENCE	SET
pt385	K	5500	LIMITS
			
pt385 200Ω385 500Ω385 1kΩ385 pt3916 pt3926 ni120 cu10	L:Jdin U:Tdin 10μV/°C B C E J K N R S T	5500 5725	to T

Select your temperature output defaults for the RTD type (factory default pt385) and TC Thermocouple) type (factory default K). When an 5725A Amplifier is connected, you may select either the 5500A Calibrator or 5725A amplifier for sourcing when each can supply the output.

T

DISPLAY OR CHANGE ENTRY LIMITS			
VOLTAGE			CURRENT
			
to V			to U

The values set here become the new limits and can be changed only with new entries or returned to factory defaults using SETUP (see menu F).

U

I+ LIM	11.0000	UPPER	LOWER
I- LIM	-11.0000	LIMIT	LIMIT
			

The current values set here become the new current limits and can be changed only with new entries or returned to factory defaults, +11,000 and -11,000, using SETUP (see menu F).

Figure 3-4. SETUP Softkey Menu Displays (cont)

F3-04f.eps

**V**

V+ LIM	1020.0000	UPPER	LOWER
V- LIM	-1020.0000	LIMIT	LIMIT
<div style="display: flex; justify-content: space-around;"> <span>▲</span> <span>▲</span> <span>▲</span> <span>▲</span> <span>▲</span> </div>			

1020.0000 to -1020.0000

The voltage values set here become the new voltage limits and can be changed only with new entries or returned to factory defaults, -1020V and 1020V, using SETUP (see menu F).

**W**

90 day spec = +/- 3,000 $\mu$ V			
1 year spec = +/- 3,000 $\mu$ V			
<div style="display: flex; justify-content: space-around;"> <span>▲</span> <span>▲</span> <span>▲</span> <span>▲</span> <span>▲</span> </div>			

SHOW SPECS is an online summary of the programmed output specifications.

**X**

STORE	CAL	REPORT	PRINT
CONSTS		SETUP	REPORTS
<div style="display: flex; justify-content: space-around;"> <span>▲</span> <span>▲</span> <span>▲</span> <span>▲</span> <span>▲</span> </div>			
	to AC	to AA	STOP REPORT

Select the desired CAL (Calibration) feature: CAL to calibrate the 5500A (see the Service Manual); CAL DATES to review when the 5500A Calibrator was last calibrated; CAL REPORTS to printout the calibration data.

**Y**

<div style="display: flex; justify-content: space-around;"> <span>⋮</span> <span>⋮</span> <span>⋮</span> <span>⋮</span> </div>			
<div style="display: flex; justify-content: space-around;"> <span>▲</span> <span>▲</span> <span>▲</span> <span>▲</span> <span>▲</span> </div>			

(Future)

**Z**

<div style="display: flex; justify-content: space-around;"> <span>⋮</span> <span>⋮</span> <span>⋮</span> <span>⋮</span> </div>			
<div style="display: flex; justify-content: space-around;"> <span>▲</span> <span>▲</span> <span>▲</span> <span>▲</span> <span>▲</span> </div>			

(Future)

Figure 3-4. SETUP Softkey Menu Displays (cont)

F3-04g.eps

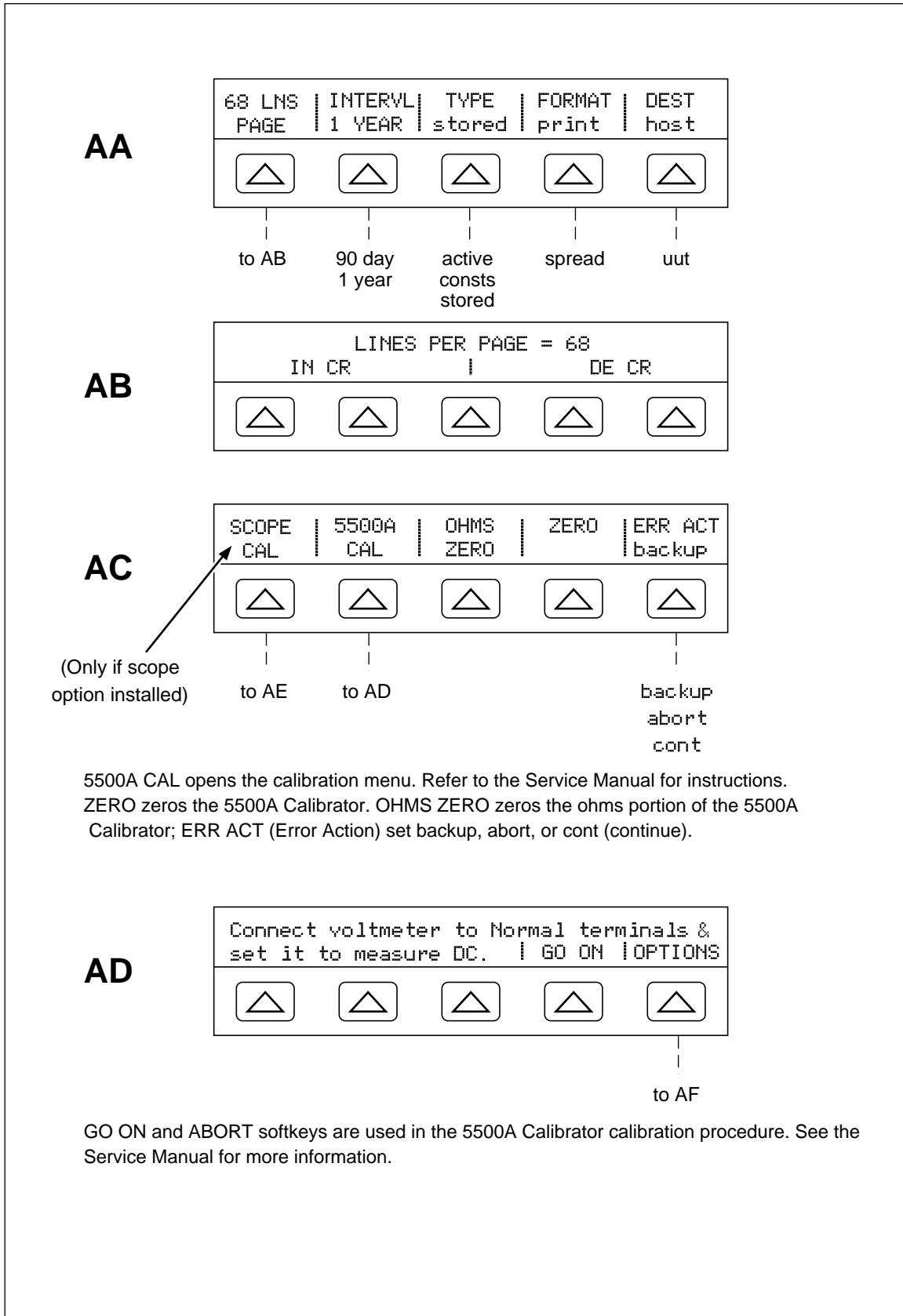

Figure 3-4. SETUP Softkey Menu Displays (cont)

F3-04h.eps



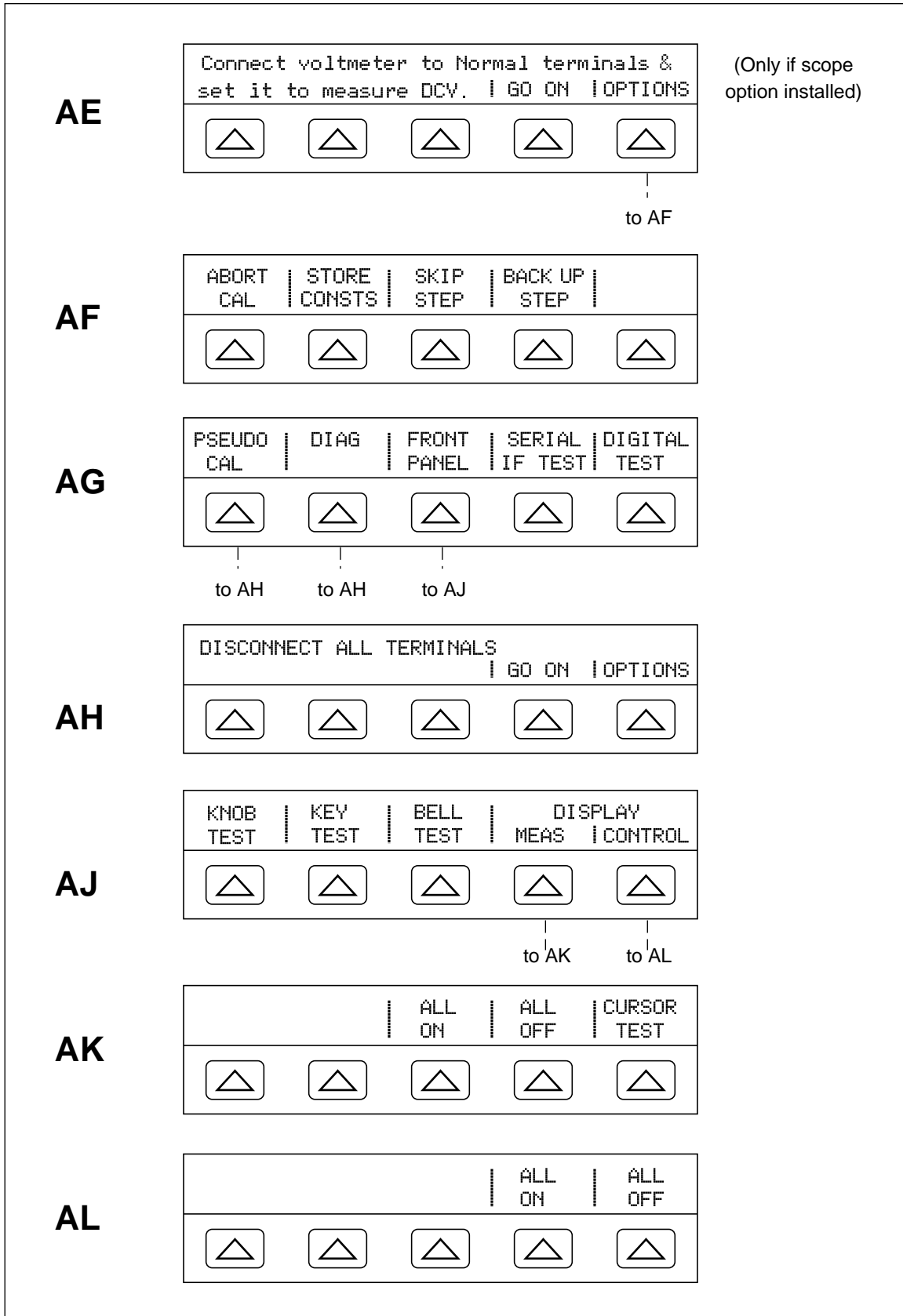

Figure 3-4. SETUP Softkey Menu Displays (cont)

F3-04i.eps

Table 3-3. Factory Default Settings for the SETUP Menus

Features			
Temperature Standard	its-90	Display Contrast*	level 7,7
Host Connection	gpib (IEEE-488)	Display Brightness*	level 1,0
GPIB Port Address	4	RTD Power Up Default Type	pt385
Serial Ports	8 bits, 1 stop bit, xon/xoff, parity none, 9600 baud, wait 30 sec.	Thermocouple Power Up Default Type	K
EOL (end of line)	CRLF	Source Preference	5500
EOF (end of file)	012,000	Current Limits	±11 A
Remote I/F	term	Voltage Limits	±1000 V
Remote commands (see Chapter 6)			
SRQSTR	SRQ: %02x %02x %04x %04x	*PUD string	cleared
* Output Display and Control Display, respectively. There are 8 levels: 0,1,2,3,4,5,6,7.			

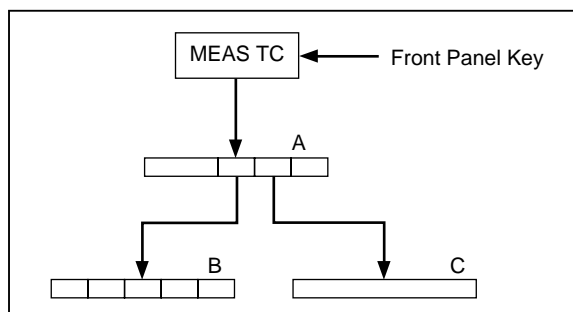

Figure 3-5. MEAS TC Softkey Menu Tree

F3-05.eps

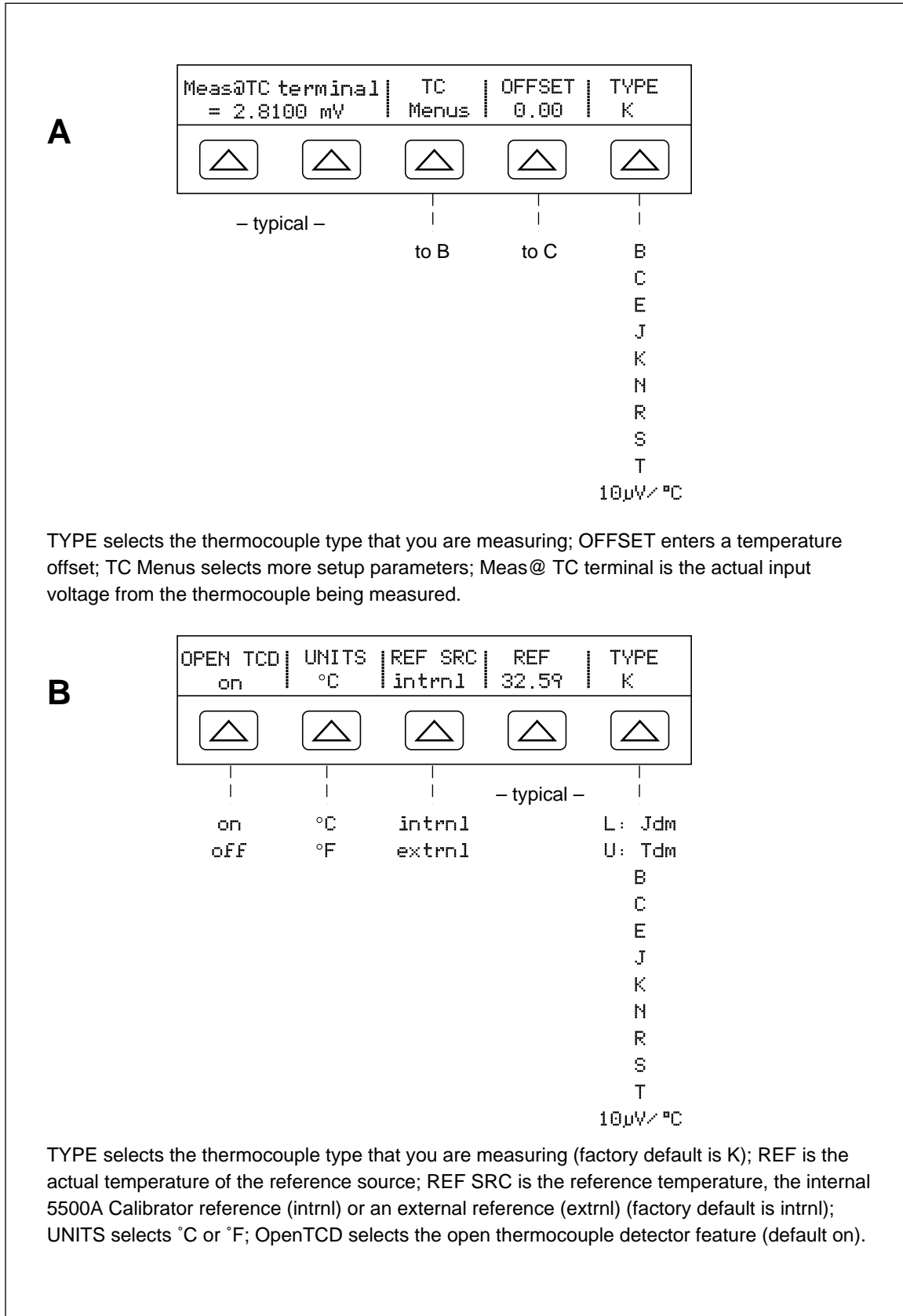

Figure 3-6. MEAS TC Softkey Menu Displays

F3-06.eps

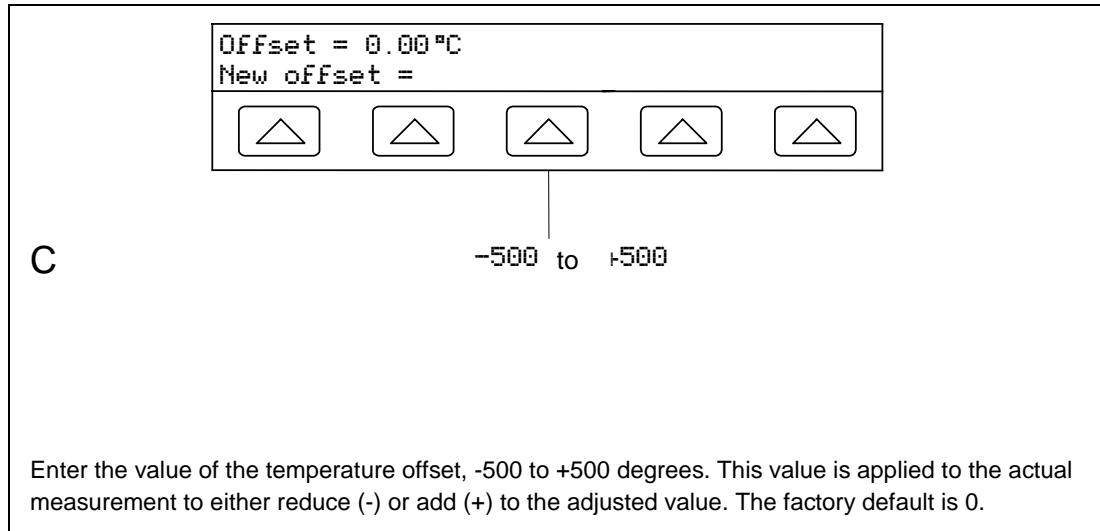

Figure 3-6. MEAS TC Softkey Menu Displays (cont)

# Chapter 4

## Front Panel Operation

	Contents	Page
4-1.	Introduction.....	4-3
4-2.	Turning on the Calibrator .....	4-3
4-3.	Warming up the Calibrator .....	4-4
4-4.	Using the Softkeys .....	4-4
4-5.	Using the Setup Menu .....	4-4
4-6.	Using the Instrument Setup Menu .....	4-5
4-7.	Selecting an External Amplifier .....	4-5
4-8.	Utility Functions Menu .....	4-6
4-9.	Using the Format EEPROM Menu .....	4-6
4-10.	Resetting the Calibrator .....	4-7
4-11.	Zeroing the Calibrator.....	4-7
4-12.	Using the Operate and Standby Modes .....	4-8
4-13.	Connecting the Calibrator to a UUT.....	4-9
4-14.	Recommended Cable and Connector Types.....	4-9
4-15.	When to Use EARTH.....	4-10
4-16.	Four-Wire versus Two-Wire Connections .....	4-10
4-17.	Cable Connection Instructions .....	4-11
4-18.	Rms Versus Peak-to-Peak Waveforms .....	4-16
4-19.	Auto Range Versus Locked Range.....	4-17
4-20.	Setting the Output.....	4-17
4-21.	Setting DC Voltage Output .....	4-18
4-22.	Setting AC Voltage Output .....	4-19
4-23.	Setting DC Current Output.....	4-21
4-24.	Setting AC Current Output.....	4-22
4-25.	Setting DC Power Output.....	4-24
4-26.	Setting AC Power Output.....	4-25
4-27.	Setting a Dual DC Voltage Output.....	4-28
4-28.	Setting a Dual AC Voltage Output.....	4-30
4-29.	Setting Resistance Output .....	4-32
4-30.	Setting Capacitance Output.....	4-33
4-31.	Setting Temperature Simulation (Thermocouple).....	4-35
4-32.	Setting Temperature Simulation (RTD).....	4-37
4-33.	Measuring Thermocouple Temperatures.....	4-39
4-34.	Waveform Types.....	4-40
4-35.	Sinewave.....	4-41

4-36.	Trianglewave .....	4-41
4-37.	Squarewave.....	4-41
4-38.	Truncated Sinewave .....	4-42
4-39.	Setting Harmonics.....	4-42
4-40.	Adjusting the Phase .....	4-43
4-41.	Entering a Phase Angle .....	4-44
4-42.	Entering a Power Factor .....	4-45
4-43.	Entering a DC Offset .....	4-46
4-44.	Using the 5725A Amplifier .....	4-47
4-45.	5725A Amplifier Output .....	4-48
4-46.	Editing and Error Output Settings .....	4-49
4-47.	Editing the Output Setting.....	4-49
4-48.	Displaying the Output Error .....	4-50
4-49.	Using Multiply and Divide.....	4-50
4-50.	Setting Output Limits .....	4-50
4-51.	Setting Voltage and Current Limits.....	4-51
4-52.	Sample Applications .....	4-52
4-53.	Calibrating an 80 Series Handheld Multimeter.....	4-52
4-54.	Cables .....	4-52
4-55.	EARTH Connection .....	4-52
4-56.	Testing the Meter .....	4-53
4-57.	Calibrating the Meter .....	4-57
4-58.	Testing a Model 41 Power Harmonics Analyzer .....	4-58
4-59.	Testing Watts, VA, VAR Performance.....	4-58
4-60.	Testing Harmonics Volts Performance .....	4-60
4-61.	Testing Harmonics Amps Performance .....	4-61
4-62.	Calibrating a Fluke 51 Thermometer .....	4-61
4-63.	Testing the Thermometer .....	4-62
4-64.	Calibrating the Thermometer.....	4-63

## 4-1. Introduction

### Warning

The 5500A Calibrator is capable of supplying lethal voltages. Do not make connections to the output terminals when any voltage is present. Placing the instrument in standby may not be enough to avoid shock hazard, since the operate key could be pressed accidentally. Press the reset key and verify that the 5500A Calibrator is in standby before making connections to the output terminals.

This chapter presents instructions for operating the 5500A Calibrator from the front panel. For a description of front panel controls, displays, and terminals, see Chapter 3, “Features.”

## 4-2. Turning on the Calibrator

### Warning

To avoid electric shock, make sure the 5500A Calibrator is safely grounded as described in Chapter 2.

### Caution

Before turning the 5500A Calibrator on, make sure that the line voltage selection is set properly. Refer to “Selecting Line Voltage” in Chapter 2 to check the line voltage setting.

When the 5500A Calibrator is powered, the initial display is “Starting Up...” (see below) and it completes a self-test routine. If a self-test fails, the Control Display identifies an error code. For a description of error codes, see Chapter 7, “Maintenance.”

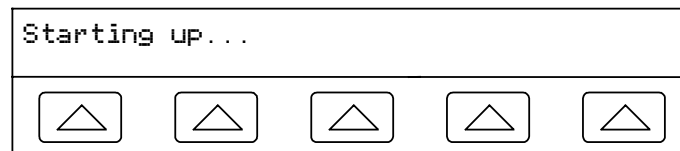

After self-test, the Control Display shows the reset condition (below).

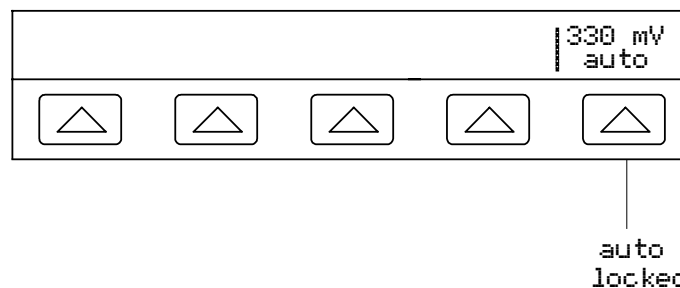

For a discussion of the softkey selection shown above (auto/locked), see “Auto Range Versus Locked Range” later in this chapter.

### 4-3. Warming up the Calibrator

When you turn on the 5500A, allow a warm-up period of at least 30 minutes for the internal components to stabilize. This ensures that the calibrator meets or exceeds the specifications listed in Chapter 1.

If you turn the 5500A Calibrator off after warm-up and then on again, allow a warm-up period of at least twice the length of time it was turned off (maximum of 30 minutes). For example, if the calibrator is turned off for 10 minutes and then on again, allow a warm-up period of at least 20 minutes.

### 4-4. Using the Softkeys

The five keys just to the right of the **PREV MENU** (Previous Menu) key are called softkeys. Softkey key functions are based on the label that appears directly above the key in the Control Display. Pressing a softkey either changes a value or causes a submenu with new selections to appear on the Control Display. Softkey menus are arranged in varying levels, as described in “Softkey Menu Tree” in Chapter 3. You can move backwards to previous menu selections by repeatedly pressing **PREV MENU**. Although pressing **RESET** will also return you to the top level menu, it will also reset all volatile settings and return the 5500A Calibrator to 0V dc in the standby mode. Use the **PREV MENU** key as your main navigating tool for moving around the menu levels.

### 4-5. Using the Setup Menu

Press the front panel **SETUP** key for access to various operations and changeable parameters. Some parameters are volatile, meaning they will be lost during reset or when power is turned off. The following descriptions will indicate which parameters are “nonvolatile.”

When you press **SETUP** from the power-up state, the display changes as follows:

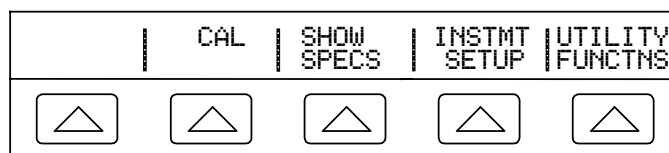

This is the primary instrument setup menu. The list below describes submenus available through each softkey and tells you where you can find further information in the manuals.

- **CAL** (Calibration) Opens the calibration menu. Softkeys in this menu activate calibration to external standards, calibration check, and dc zeros calibration. Another softkey displays calibration date information and another opens a calibration report menu. Zero calibration is described later in this chapter.
- **SHOW SPECS** (Show Specifications) [Future] Displays published 5500A Calibrator specifications, duplicating the information provided in Chapter 1 of this manual.
- **INSTMT SETUP** (Instrument Setup) Selects the desired temperature standard and opens submenus to access Output, Display, and Remote Setups.
- **UTILITY FUNCTNS** (Utility Functions) Allows you to initiate a self-test, format the nonvolatile memory, and review the instrument configuration software versions and user report string. These features are explained under “Utilities Function Menu” later in this chapter.



#### 4-6. Using the Instrument Setup Menu

The softkeys in the instrument setup menu (accessed by pressing INSTMT SETUP softkey in the Setup Menu) are shown below.

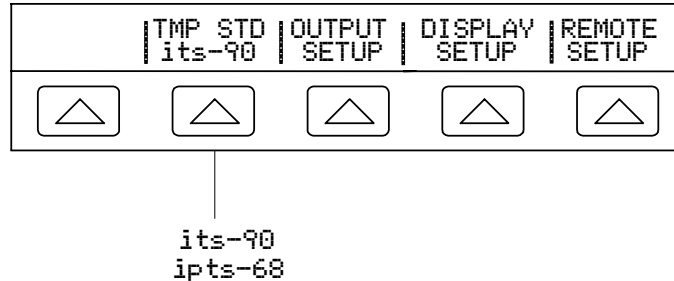

The list below describes submenus accessed by each softkey.

- **TMP STD** (Temperature Standard) Toggles the degree reference between the 1968 International Provisional Temperature Standard (ipts-68) and the 1990 International Temperature Standard (its-90) (factory default). This setting is saved in the nonvolatile memory.
- **OUTPUT SETUP** Opens the Output Setup menu to select the source of the output signals (5500A or 5725A), current and voltage output limits, thermocouple type, and RTD type.
- **DISPLAY SETUP** Opens submenus to set the brightness and contrast of both the Control Display and Output Display.
- **REMOTE SETUP** Allows you to change the configuration of the two RS-232 ports, SERIAL 1 FROM HOST and SERIAL 2 TO UUT, and IEEE-488 General Purpose Interface Bus (GPIB). (See Chapter 5, “Remote Operation” for more information.)

#### 4-7. Selecting an External Amplifier

When the 5500A Calibrator is operated in conjunction with the 5725A Amplifier, you must select the 5500A or the 5725A as the preferred source of the output signals. The SOURCE PREFERENCE (Source Preference) selection is applicable only whenever the 5500A or the 5725A can produce the output, or overlap capability. To select a source preference, proceed as follows:

1. Press the **SETUP** key to display the Setup Menu.
2. Press the INSTMT SETUP softkey to open the Instrument Setup Menu.
3. Press the OUTPUT SETUP softkey to display the SOURCE PREFERENCE softkey.

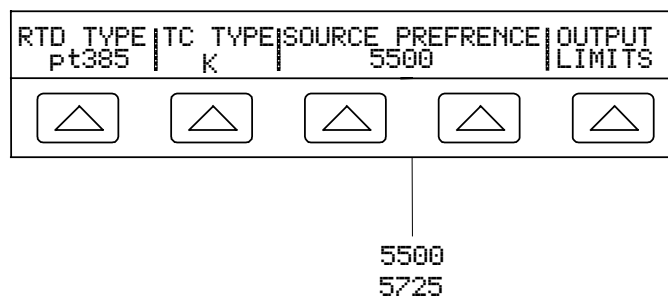

4. Press a SOURCE PREFERENCE softkey to select the 5500 or 5725 (if connected). This setting is saved in the nonvolatile memory.

#### 4-8. Utility Functions Menu

The Setup Menu softkey labeled UTILITY FUNCTNS (Utility Functions) provides access to Self Test, Format Nonvolatile Memory, and Instrument Configuration.

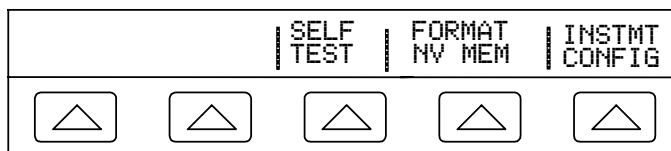

- **SELF TEST** This softkey initiates a calibrator selftest.
- **FORMAT NV MEM** (Format Nonvolatile Memory) Opens a menu to restore all or part of the data in the nonvolatile memory (EEPROM) to factory defaults.
- **INSTMT CONFIG** (Instrument Configuration) Allows you to view the versions of software installed in the calibrator as well as the user-entered report string.

#### 4-9. Using the Format EEPROM Menu

##### Caution

**Use with extreme care. The format nonvolatile memory menu softkeys permanently erase calibration constants. Pressing ALL or CAL invalidates the state of calibration of the 5500A.**

Pressing FORMAT NV MEM in the utility functions menu opens the following:



All the softkeys in this menu require the rear panel CALIBRATION switch to be in the ENABLE position. The nonvolatile memory contains calibration constants and dates, setup parameters, and the user report string. In the case of calibration constants, factory defaults are the same for all Calibrators. They are not the calibration constants obtained when the 5500A was calibrated by the factory before shipment. The softkeys are:

- **ALL** Replaces the entire contents of the EEPROM with factory defaults. This would be used by service personnel after replacing the EEPROM, for example. It is not required in normal use.
- **CAL** Replaces all calibration constants with factory defaults but leaves all the setup parameters unchanged. This is also not required in normal use.
- **SETUP** Replaces the setup parameters with factory defaults (Table 4-1) but leaves the state of calibration unchanged. You do not have to break the calibration sticker for this operation. Note that remote commands can change the setup parameters. (See these commands in Chapter 6: SRQSTR, SPLSTR, \*PUD, SP\_SET, UUT\_SET, TEMP\_STD, SRC\_PREF, RTD\_TYPE\_D, TC\_TYPE\_D, LIMIT.)

Table 4-1. Factory Defaults for SETUP

Features			
Temperature Standard	its-90	Display Contrast*	level 7,7
Host Connection	gpib (IEEE-488)	Display Brightness*	level 1,0
GPIB Port Address	4	RTD Power Up Default Type	pt385
Serial Ports	8 bits, 1 stop bit, xon/xoff, parity none, 9600 baud, wait 30 sec.	Thermocouple Power Up Default Type	K
EOL (end of line)	CRLF	Source Preference	5500
EOF (end of file)	012,000	Current Limits	±11 A
Remote I/F	term	Voltage Limits	±1020 V
Remote commands (see Chapter 6)			
SRQSTR	SRQ: %02x %02x %04x %04x	* PUD string	cleared
* Output Display and Control Display, respectively. There are 8 levels: 0,1,2,3,4,5,6,7.			

## 4-10. Resetting the Calibrator

At any time during front panel operation (not remote operation), you can return the 5500A Calibrator to the power-up state by pressing **RESET**, except after an error message, which is cleared by pressing a blue softkey. Pressing the **RESET** key does the following:

- Returns the calibrator to the power-up state: 0 V dc, standby, 330 mV range and all OUTPUT SETUP menus set to their most recent default values.
- Clears the stored values for limits and error mode reference.

## 4-11. Zeroing the Calibrator

Zeroing recalibrates internal circuitry, most notably dc offsets in all ranges of operation. To meet the specifications in Chapter 1, zeroing is required every seven days, or when the 5500A Calibrator ambient temperature changes by more than 5°C. Zeroing is particularly important when your calibration workload has 1 mΩ and 1 mV resolution, and when there are significant temperature changes in the 5500A Calibrator work environment. There are two zeroing functions: total instrument zero (ZERO) and ohms-only zero (OHMS ZERO).

Complete the following procedure to zero the calibrator. (Note: The 5500A Calibrator rear-panel CALIBRATION switch does not have to be enabled for this procedure.)

1. Turn on the Calibrator and allow a warm-up period of at least 30 minutes.
2. Press the **RESET** key.
3. Install a copper short circuit in the front panel TC connector (total instrument zero only).

4. Press the **SETUP** key, opening the setup menu (below).

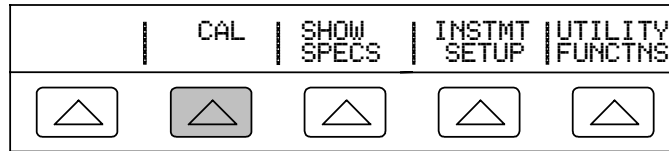

5. Press the CAL softkey, opening the calibration information menu (below).

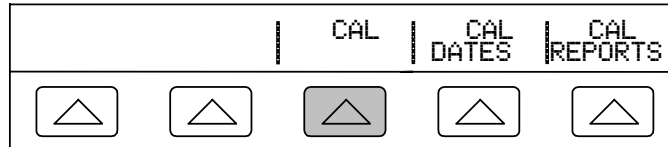

6. Press the CAL softkey, opening the calibration activity menu (below).

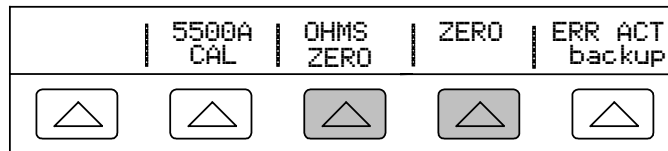

7. Press the ZERO softkey to totally zero the 5500A Calibrator; press the OHMS ZERO softkey to zero only the ohms function. After the zeroing routine is complete (several minutes), press the **RESET** key to reset the calibrator.

## 4-12. Using the Operate and Standby Modes

When the OPERATE annunciator is lit and OPR is displayed, the output value and function shown on the Output Display is active at the selected terminals. When STBY is displayed in the Output Display, all calibrator outputs are open-circuited except for the front panel thermocouple (TC) terminals. To enable the operate mode, press **OPR**. To place the calibrator in standby, press **STBY**.

If the calibrator is operating and any of the following events occur, the calibrator automatically goes into the standby mode:

- The **RESET** key is pressed.
- A voltage  $\geq 33$  V is selected when the previous output voltage was less than 33 V.
- Output function is changed between ac or dc voltage when the output voltage is  $\geq 33$  V; ac or dc current; temperature and any other function; resistance and any other function; capacitance and any other function.
- A peak-to-peak voltage output (squarewave, trianglewave, or truncated sinewave) changes to rms voltage output  $\geq 33$  V (sinewave). For example, if a peak-to-peak output of 40 V is changed to rms output of 40 V by changing the waveform using the WAVE softkey, the calibrator goes into the standby mode.
- The output location is changed, for example by selecting an amplifier. (Excluding selecting the 5725A for ac voltage, or for current if the 5500A current output location is set to 5725A.)
- An overload condition is detected.

### 4-13. Connecting the Calibrator to a UUT

  **Warning**

The 5500A Calibrator is capable of supplying lethal voltages. Do not make connections to the output terminals when a voltage is present. Placing the instrument in standby may not be enough to avoid shock hazard, since the **OPR** key could be pressed accidentally. Press reset and verify that the **STBY** annunciator is lit before making connections to the output terminals.

The outputs labeled NORMAL (HI and LO) are used to source voltages, resistances, capacitance and resistance temperature detector (RTD) calibration values. The LO terminal is tied to analog common, which may be tied to earth ground or floated with the **EARTH** key. Voltages generated by the 5725A may be routed through these outputs.

The outputs labeled AUX (HI and LO) source current and low voltages in the dual voltage function. These outputs are also used for four-wire or remote sensing in the resistance, capacitance and RTD functions.

When the scope option is installed, the BNC connectors labeled Scope and Trig Out deliver voltage signals for Oscilloscope calibration.

The socket labeled TC is used to measure thermocouples and to generate simulated thermocouple outputs.

### 4-14. Recommended Cable and Connector Types

  **Warning**

Using standard banana plugs on the calibrator output will expose lethal voltages when not completely inserted into a mating jack. Fluke recommends the use of safety shrouded plugs when working with voltages of 33 volts or greater.

 **Caution**

**To prevent possible equipment damage, use only cables with correct voltage ratings.**

Cables to the calibrator are connected to the NORMAL and AUX jacks. To avoid errors induced by thermal voltages (thermal emfs), use connectors and conductors made of copper or materials that generate small thermal emfs when joined to copper. Avoid using nickel-plated connectors. Optimum results can be obtained by using Fluke Model 5440A-7002 Low Thermal EMF Test Leads, which are constructed of well-insulated copper wire and tellurium copper connectors. (See Chapter 9, “Accessories.”)

#### 4-15. When to Use EARTH

The 5500A Calibrator front panel NORMAL LO terminal is isolated from the chassis (earth) ground. When it is desired to make a connection between the NORMAL LO terminal and earth ground, press the **EARTH** button, lighting the button annunciator. The default condition is off (annunciator not on).

To avoid ground loops and noise you must have only one ground connection in the system. Usually you make all signal ground connections at the UUT and verify the **EARTH** annunciator is off. For the 330  $\mu$ A range and synthesized resistance and capacitance, be sure the **EARTH** annunciator is off. Generally, **EARTH** is on only for ac and dc volts where the UUT is battery operated and completely isolated from earth ground. There must, however, be a safety ground for the 5500A. See “Connecting to Line Power” in Chapter 2. When enabled by the sourced output, a softkey **L $\bar{O}$  $\bar{E}$**  appears, which allows you to tie or open an internal connection between the NORMAL LO terminal and AUX LO terminal. When tied and **EARTH** is on, then both LO terminals are tied to chassis ground.

#### 4-16. Four-Wire versus Two-Wire Connections

Four-wire and two-wire connections refer to methods of connecting the 5500A to the UUT to cancel out test lead resistance to assure the highest precision of the calibration output. Figures 4-1 through 4-3 illustrate the connection configurations for resistance; Figures 4-4 through 4-6 illustrate connection configurations for capacitance. The external sensing capability of the four- and two-wire compensated connections provides increased precision for resistance values below 110 k $\Omega$  and capacitance values 110 nf and above. Part of the setting up the calibrator output for resistance and capacitance includes selections for four-wire compensation (COMP 4-wire), two-wire compensation (COMP 2-wire) and two-wire no compensation (COMP off). (See “Setting Resistance Output” and “Setting Capacitance Output” later in this chapter.) Note that compensated connections for capacitance are to compensate for lead and internal resistances, not for lead and internal capacitances.

**Four-Wire Connection** The four-wire connection is typical for calibrating laboratory measurement equipment. Increased precision is provided for resistance values below 110 k $\Omega$  and capacitance values 110 nF and above. For other values, the lead resistances do not degrade the calibration and the Calibrator changes the compensation to off (COMP off).

**Two-Wire Compensation** The two-wire connection is typical for calibrating precision handheld Digital Multimeters (DMMs) with a two-wire input. Increased precision is provided for resistance values below 110 k $\Omega$  and capacitance values 110 nf and above. For other values, the Calibrator changes the compensation to off (COMP off).

**Compensation Off** Compensation off is a typical connection for calibrating handheld analog meters or DMMs with a two-wire input. This connection is used for all values of resistance and capacitance and is usually selected when the analog meter or DMM level of accuracy does not require the additional precision. This is the default condition whenever an ohms or capacitance output is made, following an output that was not ohms or capacitance.

**4-17. Cable Connection Instructions**

Table 4-2 indicates a figure reference for each type of connection between a UUT and the 5500A Calibrator, referencing Figures 4-1 through 4-10.

When calibrating Resistance Temperature Detectors (RTDs) using the three-terminal connection shown in Figure 4-9, be sure the test leads have identical resistances to cancel any errors due to lead resistance. This can be accomplished, for example, by using three identical test lead lengths and identical connector styles.

When calibrating thermocouples, it is especially important to use the correct hookup wire and miniconnector between the Calibrator front panel TC jack and the UUT. You must use thermocouple wire and miniconnectors that match the type of thermocouple. For example, if simulating a temperature output for a K thermocouple, use K-type thermocouple wire and K-type miniconnectors for the hookup.

To connect the calibrator to a UUT, proceed as follows:

1. If the calibrator is turned on, press **RESET** to remove the output from the calibrator terminals.
2. Make the connections to the UUT by selecting the appropriate figure from Table 4-2.
3. For capacitance outputs, null out stray capacitance by connecting the test leads to the UUT, routing them (but not connecting) to the 5500A Calibrator on a non-conductive surface. Null out the reading on the UUT using “rel,” “offset,” or “null,” whichever method applies, and then connect the test leads to the 5500A Calibrator.

**Table 4-2. UUT Connections**

5500A Output	Figure Reference
Resistance	4-1 Resistance - four-wire compensated 4-2 Resistance - two-wire compensated 4-3 Resistance - compensation off
Capacitance	4-4 Capacitance - four-wire compensated 4-5 Capacitance - two-wire compensated 4-6 Capacitance - compensation off
DC Voltage	4-7 DC Voltage/AC Voltage
AC Voltage	4-7 DC Voltage/AC Voltage
DC Current	4-8 DC Current/AC Current
AC Current	4-8 DC Current/AC Current
Temperature	4-9 Temperature (Resistance Temperature Detector)(RTD) 4-10 Temperature (Thermocouple)

Note: See the discussion under “Four-Wire versus Two-Wire Connections” above.

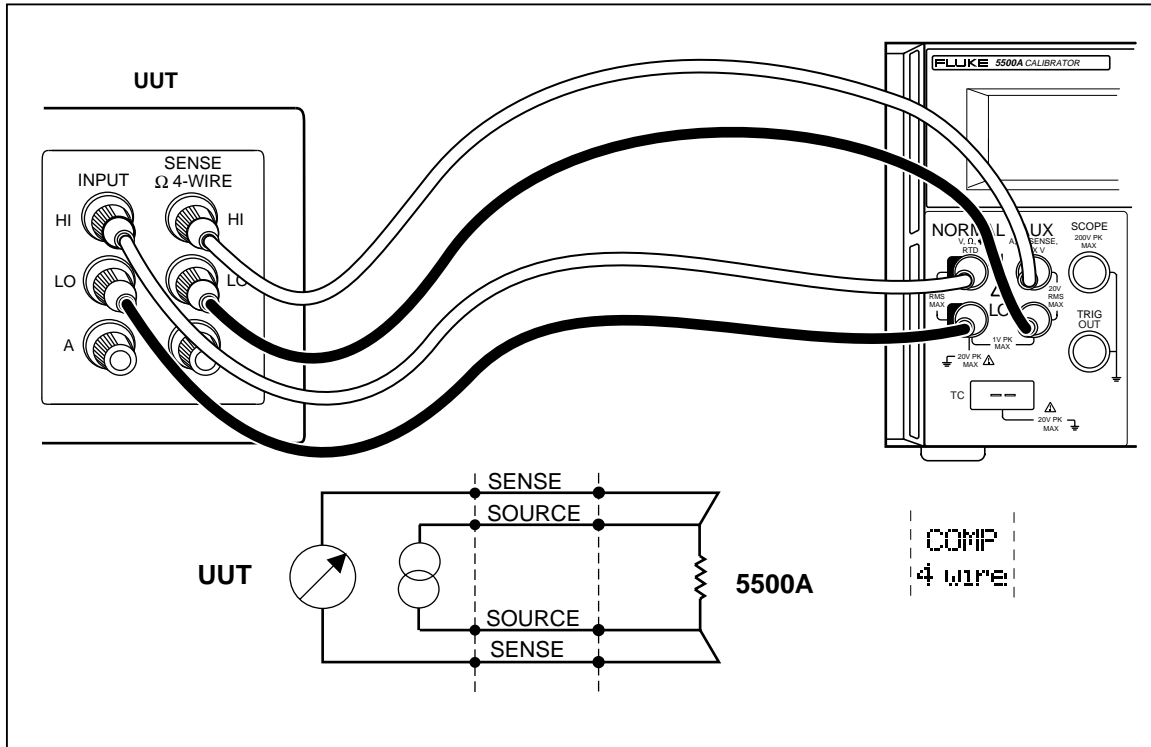

Figure 4-1. UUT Connection: Resistance (Four-Wire Compensation)

f4-01.eps

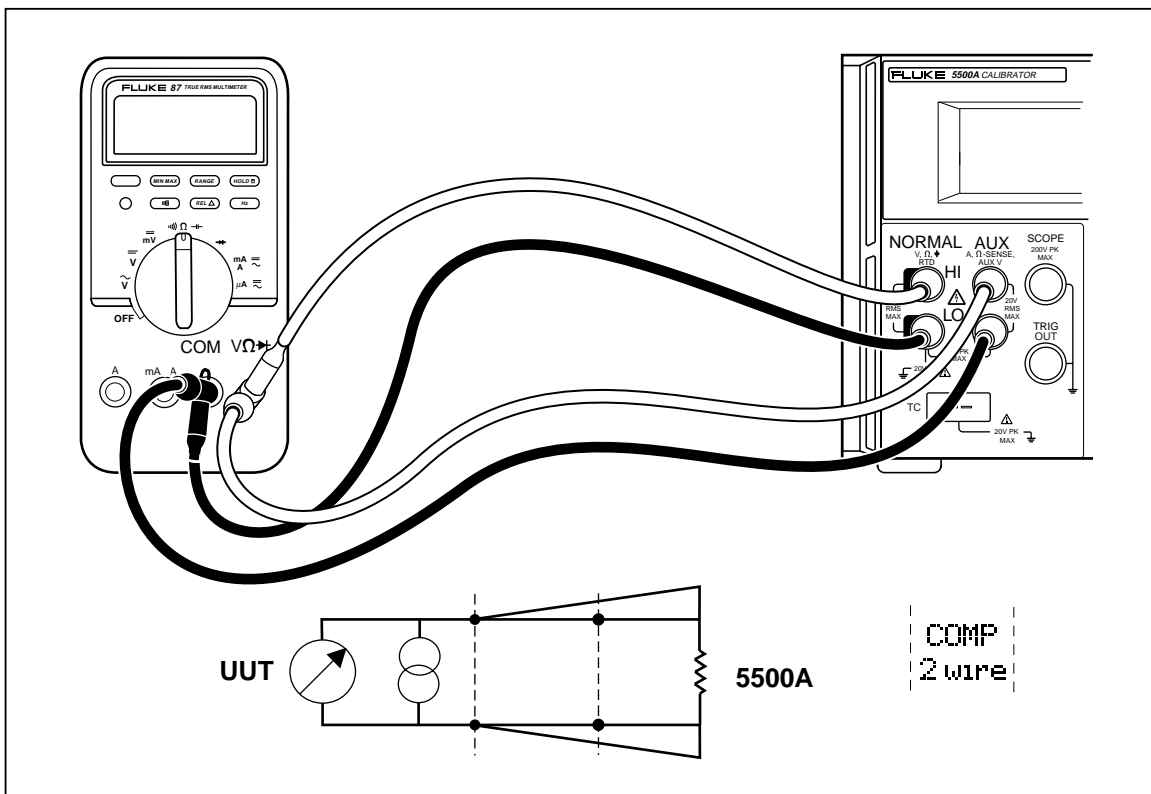

Figure 4-2. UUT Connection: Resistance (Two-Wire Compensation)

f4-02.eps



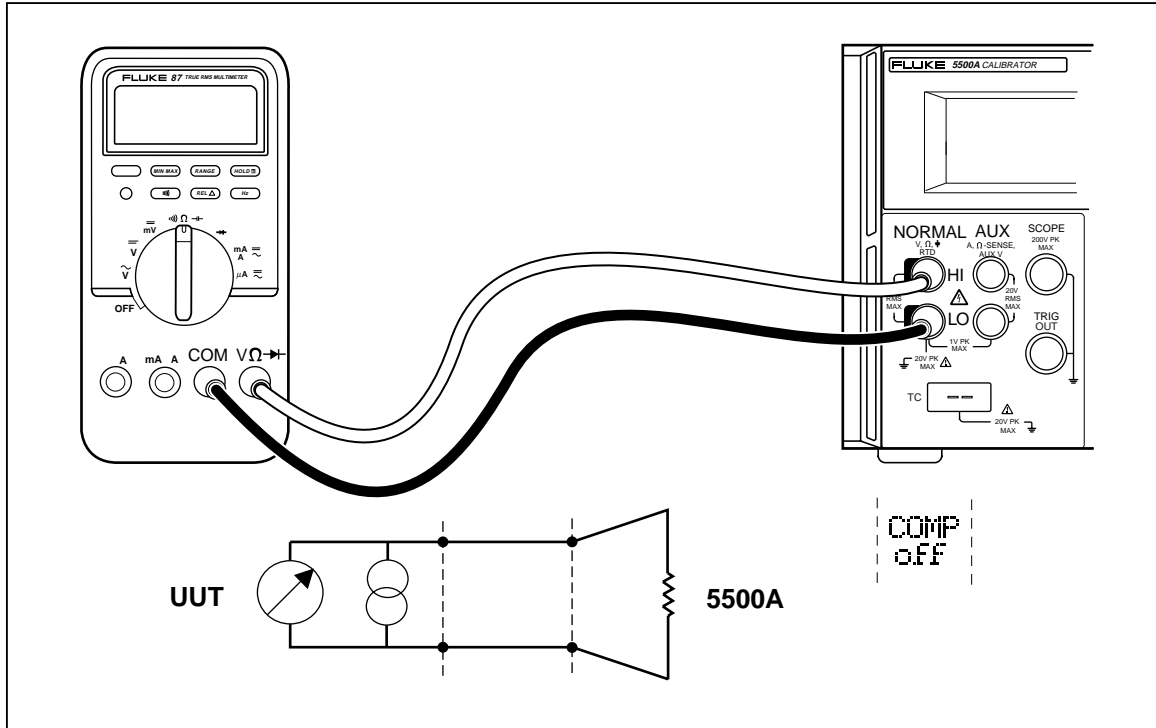

Figure 4-3. UUT Connection: Resistance (Compensation Off)

f4-03.eps

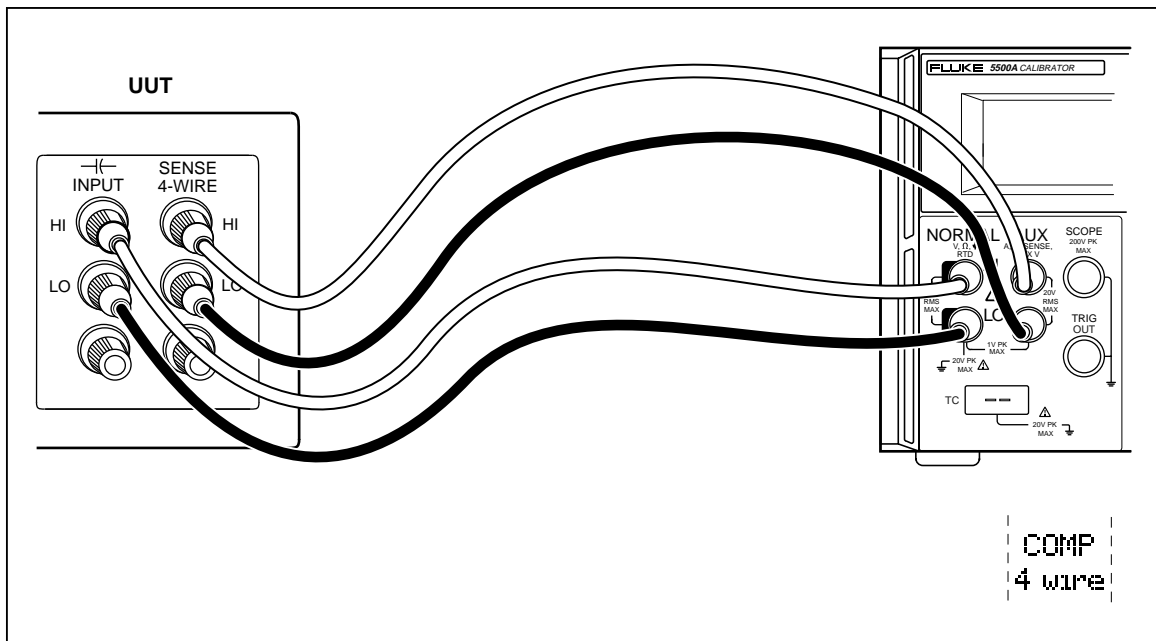

Figure 4-4. UUT Connection: Capacitance (Four-Wire Compensation)

F4-04.eps

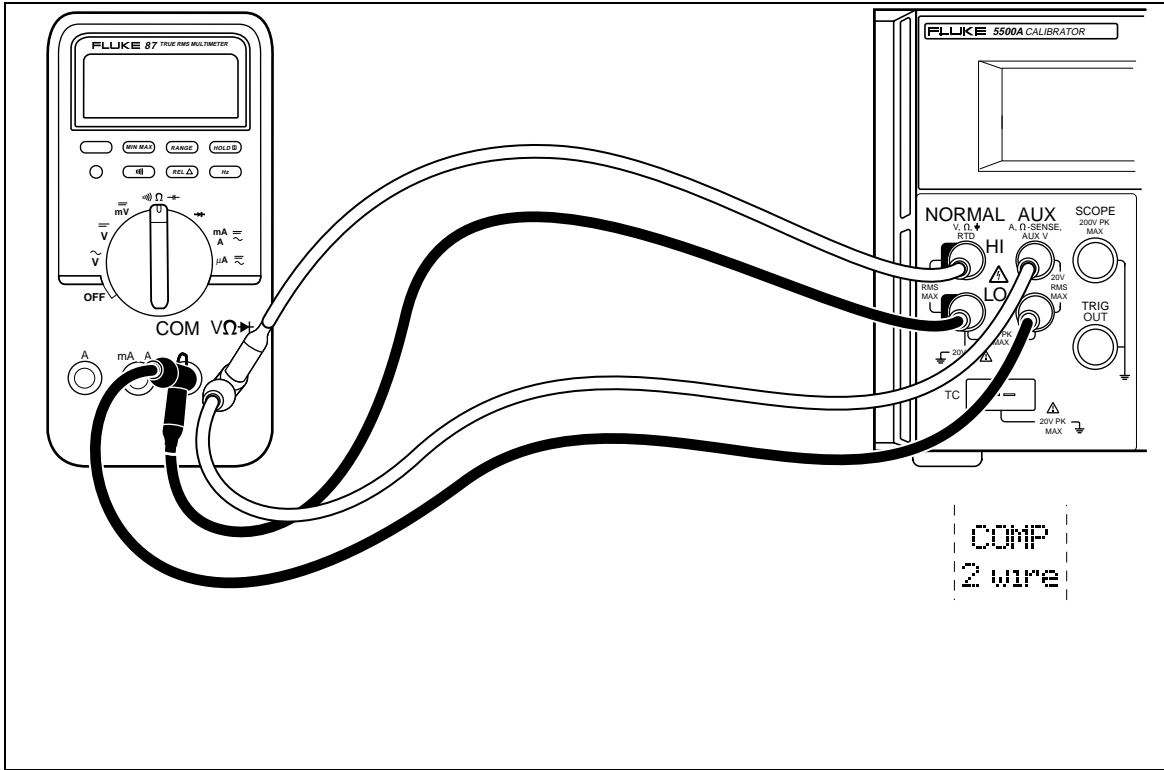

Figure 4-5. UUT Connection: Capacitance (Two-Wire Compensation)

f4-05.eps

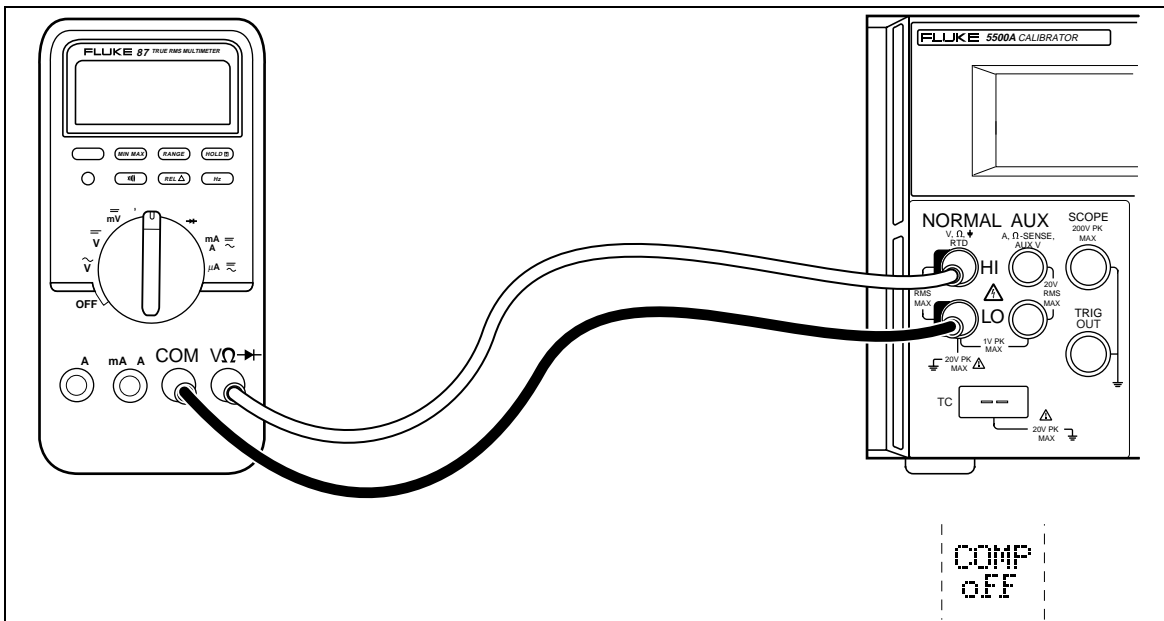

Figure 4-6. UUT Connection: Capacitance (Compensation Off)

f4-06.eps

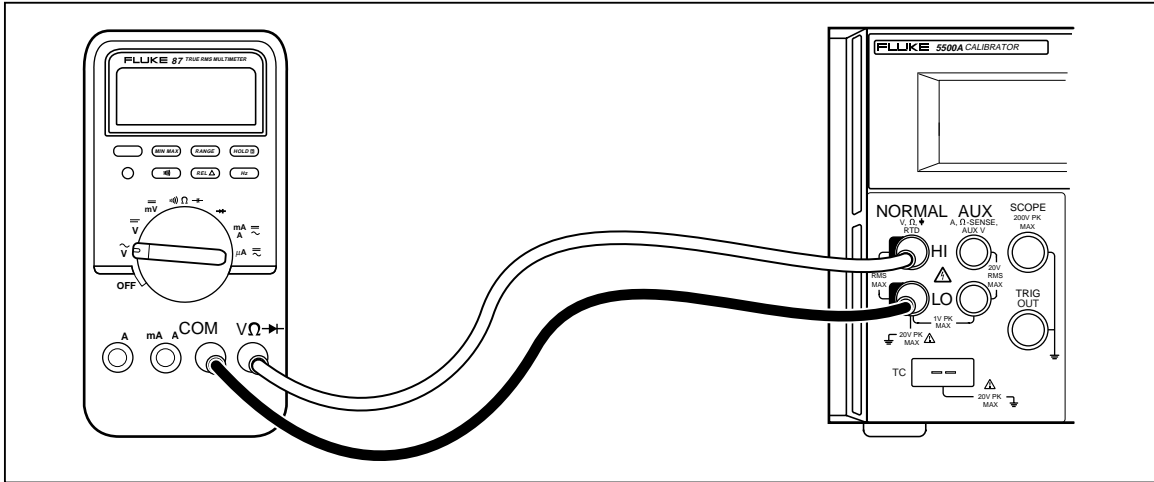

Figure 4-7. UUT Connection: DC Voltage/AC Voltage

f4-07.eps

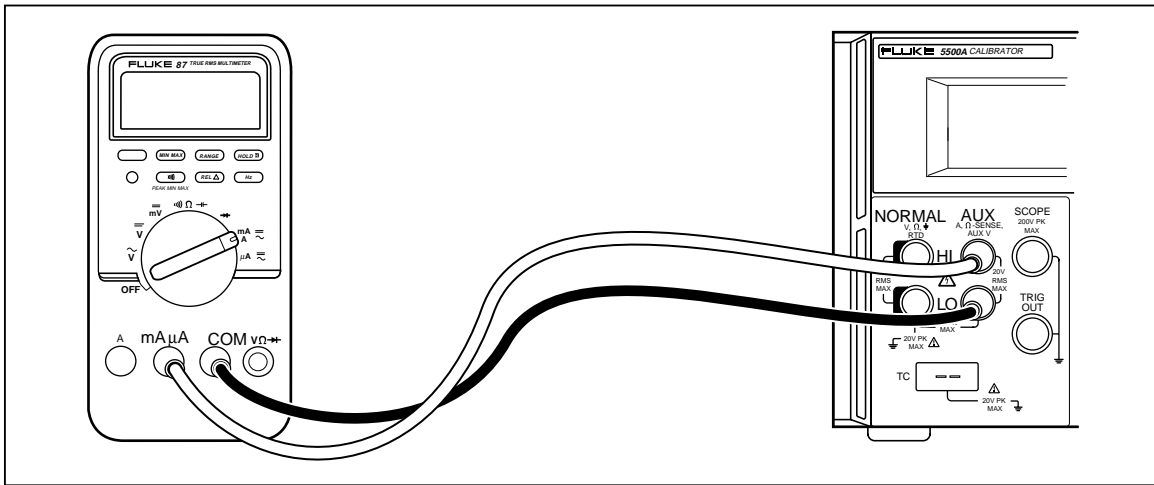

Figure 4-8. UUT Connection: DC Current/AC Current

f4-08.eps

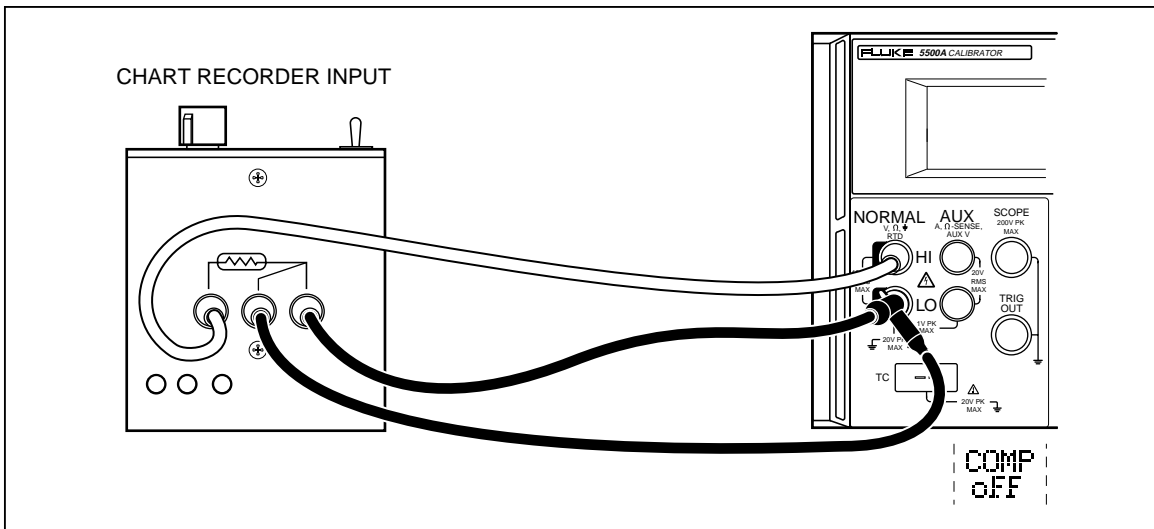

Figure 4-9. UUT Connection: Temperature (RTD)

f4-09.eps

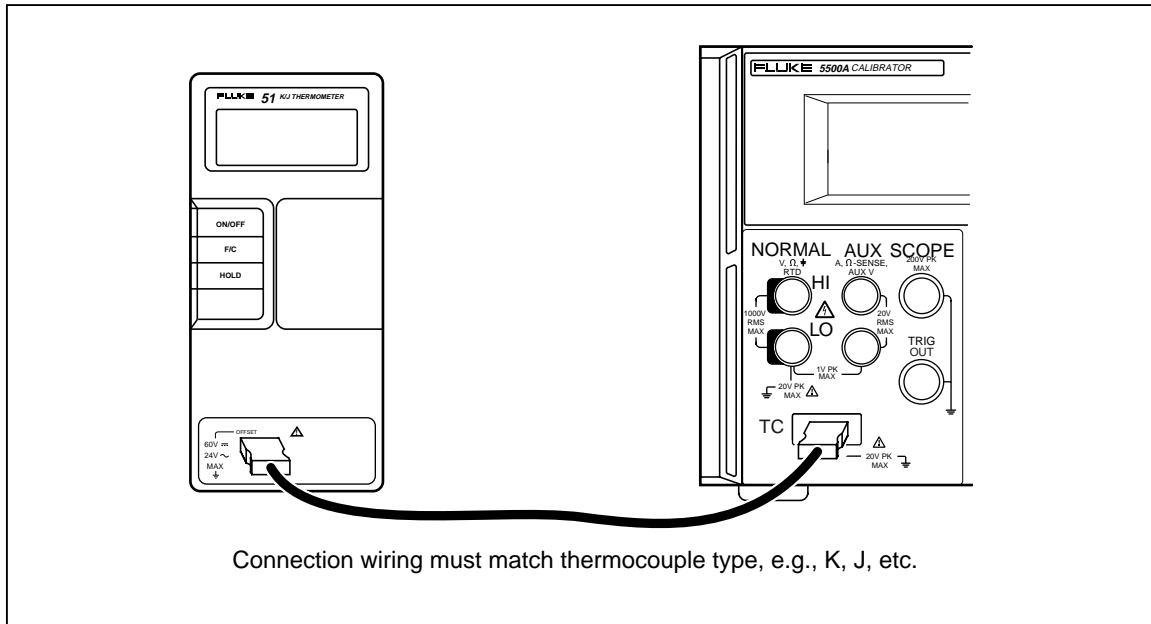

Figure 4-10. UUT Connection: Temperature (Thermocouple)

f4-10.eps

## 4-18. Rms Versus Peak-to-Peak Waveforms

The 5500A Calibrator ranges for ac functions are specified in rms (root-mean-square; the effective value of the waveform). For example, 1.0 - 32.999 mV, 33 - 329.999 mV, 0.33 - 3.29999 V and so forth. The sinewave outputs are in rms, while the trianglewave, squarewave, and truncated sinewave outputs are in peak-to-peak. The relationship between peak-to-peak and rms for the non-sinewave types are as follows:

- **Squarewave** peak-to-peak x 0.5000000 = rms
- **Trianglewave** peak-to-peak x 0.2886751 = rms
- **Truncated Sinewave** peak-to-peak x 0.2165063 = rms

While the ac function ranges are directly compatible for sinewaves, the rms content of the other waveforms is less apparent. This characteristic leads to subtle calibrator range changes. For example, if you enter a sinewave voltage of 6 V (rms assumed), the selected range is 3.3 to 32.9999 V. If you then use the softkeys to change from a sinewave to a trianglewave, for example, the display changes from 6 V rms to 6 V peak-to-peak. This translates to 6 V peak-to-peak x 0.2886751 = 1.73205 V rms, and the range switches to 0.33 to 3.29999 V. The Output Display shows the range change because the sinewave voltage is displayed as 6.0000, the resolution for the 3.3 to 32.9999 V range, while the trianglewave is displayed as 6.00000, the resolution for the 0.33 to 3.29999 V range.

You need to know the active range to enter the correct values for voltage offset because the maximum offsets are range specific. For example, the maximum peak signal for the 3.3 to 32.9999 V range is 55 V while the maximum peak signal for the 0.33 to 3.29999 V range is 8 V. This means in the example above, the 6 V rms sinewave could have offsets applied up to the maximum peak signal of 55 V because the active range is 3.3 to 32.9999 V, while the 6 V peak-to-peak trianglewave could have offsets applied up to the maximum peak signal of 8 V because the active range is 0.93 to 9.29999 V. See “Specifications” in Chapter 1 and “Entering a DC Offset” later in this chapter for more information about dc offset voltages.

## 4-19. Auto Range Versus Locked Range

A softkey is provided to toggle between the ranging method auto or locked. This feature is available only for single-output dc volts and dc current outputs.

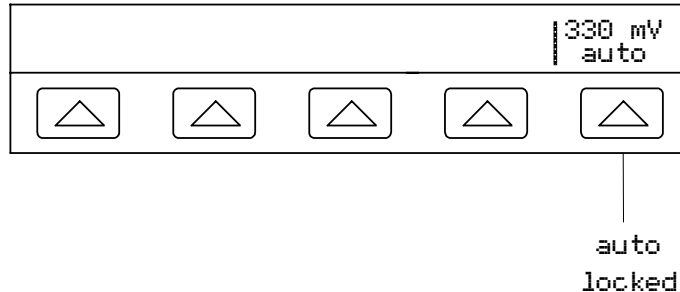

When auto is selected (the default setting), the calibrator automatically selects the range that provides the best output resolution. When locked is selected, the calibrator locks the selected range and will not change ranges when you are editing the output, or entering new outputs. Values lower or higher than the locked range are not allowed. The locked selection is usually made when you do not want range changes that may cause a small perturbation in the output, e.g., when checking the linearity of a given multimeter range.

## 4-20. Setting the Output

Setting the calibrator output is similar to entering values into a calculator: press the keys that represent the value you desire and then press a units key to identify which of the volts, amps, hertz, etc. you want the value to represent. The control display indicates the value and units you select as you type them into the calibrator. Once you are satisfied with the value and units, press **ENTER**. If the output display indicates STBY, press **OPR** to output the selection. The display of a small “u” (unsettled) in the Output Display indicates the calibrator is allowing for its internal circuitry to settle.

For example, to set the output to 10 V dc, press:

**1** → **0** → **<sup>dBm</sup>V** → **ENTER** → **OPR**

To set the output to 20 V ac at 60 Hz, press:

**2** → **0** → **<sup>dBm</sup>V** → **6** → **0** → **<sup>sec</sup>Hz** → **ENTER** → **OPR**

To change the output to dc, press:

**0** → **<sup>sec</sup>Hz** → **ENTER** or **+/-** → **ENTER**

Step-by-step procedures are provided for each output function as follows:

- DC voltage
- AC voltage
- DC current
- AC current
- DC power
- AC power
- Dual DC voltage

- Dual AC voltage
- Capacitance
- Temperature - RTD
- Temperature - Thermocouple
- Resistance
- Boost operation (using an auxiliary amplifier)

#### 4-21. Setting DC Voltage Output

Complete the following procedure to set a dc voltage output at the 5500A front panel NORMAL terminals. If you make an entry error, press **CE** to clear the display, then reenter the value.

#### Caution

**Verify the applied voltage to the UUT does not exceed the rating of the UUT insulation.**

1. Press **RESET** to clear any output from the 5500A.
2. Connect the UUT as described earlier in this chapter under “Connecting the Calibrator to a UUT.”
3. Set the UUT to measure dc voltage on the desired range.
4. Press the numeric keys and decimal point key to enter the desired voltage output (maximum seven numeric keys). For example, 123.4567.

#### Note

*At voltage outputs of 100 volts and above (nominal), you may notice a slight high-pitched sound. This is normal.*

5. Press **+/-** to select the polarity of the voltage (default is +).
6. Press a multiplier key, if necessary. For example, press **μm**.
7. Press **<sup>dBm</sup>V**.
8. The Control Display now shows the amplitude of your entry. For example, 123.4567 mV (below).

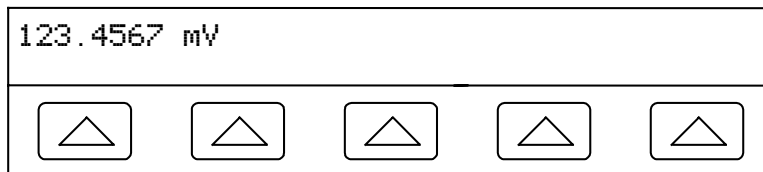

9. Press **ENTER**. The calibrator clears your entry from the Control Display and copies it into the Output Display (below is typical).

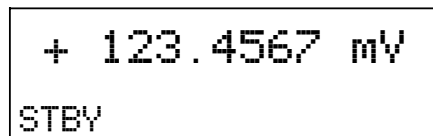

10. Press **OPR** to activate the calibrator output.

A softkey label for range appears on the Control Display in the dc voltage function.

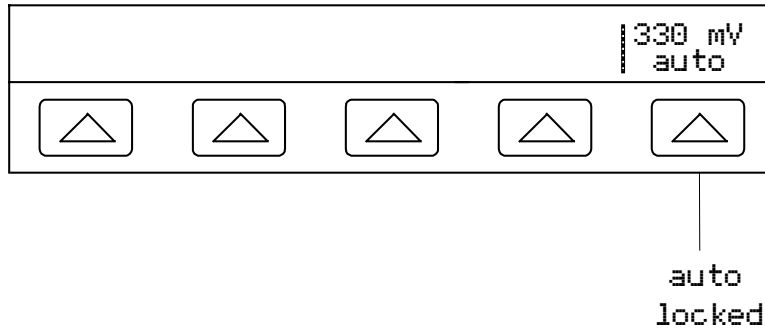

- **Range** (Operating Range) Selects autorange (auto) or lock (locked) for the present range. When auto (the default setting) is selected, the calibrator automatically selects the range that provides the best output resolution. When locked is selected, the calibrator will not change ranges when you are editing the output. The locked selection is usually made when you do not want range changes that may cause a small perturbation in the output, e.g., when checking the linearity of a given multimeter range.

#### 4-22. Setting AC Voltage Output

You may select an ac voltage output in volts or as a power output in dBm, where dBm is  $10 \log(P_{\text{out}}/.001) = \text{dBm}$  ( $P_{\text{out}}$  is expressed in watts). The output range is 1 mV to 1000 V (-57.78 to +62.21 dBm). When selecting dBm outputs, the 5500A calculates dBm assuming a load impedance of 600  $\Omega$ . Therefore, the dBm output may be used directly only when calibrating instruments with a 600  $\Omega$  input impedance. Based on this, the formula is:

$$20 \log(V_{\text{output}}/0.774597) = \text{dBm}.$$

For example, for a voltage output of 2.44949, the equivalent dBm power output is:

$$20 \log(2.44949/0.774597) = 20 \log(3.162278) = 10 \text{ dBm}$$

Complete the following procedure to set an ac voltage output at the 5500A front panel NORMAL terminals. If you make an entry error, press **CE** to clear the display, then reenter the value.

#### Caution

**Verify the applied voltage to the UUT does not exceed the rating of the UUT insulation.**

1. Press **RESET** to clear any output from the 5500A.
2. Connect the UUT as described earlier in this chapter under “Connecting the Calibrator to a UUT.”
3. Set the UUT to measure ac voltage on the desired range.
4. **Output in volts** Press the numeric keys and decimal point key to enter the desired voltage output (maximum six numeric keys). For example, 2.44949.

**Output in dBm** Press the numeric keys and decimal point key to enter the desired power output (maximum six numeric keys). For example, 10.0000. For a power output less than 1 mW (negative dBm values), press **+/-** to append the numeric entry with the negative (-) symbol.

Note

At voltage outputs of 100 volts and above (nominal), you may notice a slight high-pitched sound. This is normal.

5. Press a multiplier key, if necessary. For example, press  $\mu$  m.
6. **Output in volts** Press  $\text{dBmV}$ .
- Output in dBm** Press  $\text{SHIFT dBmV}$ .
7. The Control Display now shows the amplitude of your entry. For example, 2.44949 V (below).

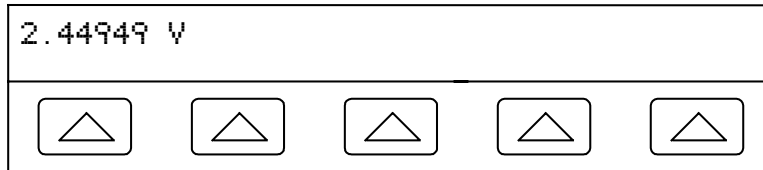

8. Press the numeric keys and decimal point key to enter the desired frequency output (maximum five numeric keys). Press a multiplier key, if necessary. For example, press the kilo multiplier key  $\text{K}$ . Then press the  $\text{Hz}$  key. For example, 1.1234 kHz (below).

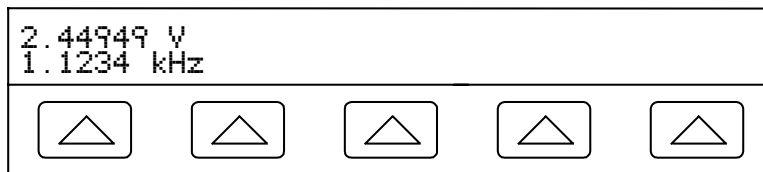

9. Press  $\text{ENTER}$ . The calibrator clears your entry from the Control Display and copies it into the Output Display (below is typical).

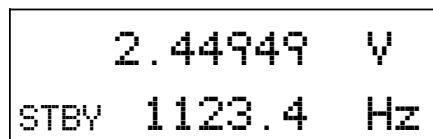

10. Press  $\text{OPR}$  to activate the calibrator output.

Several softkey labels appear on the Control Display in the ac voltage function, depending on which waveform is selected: DUTY, OFFSET and WAVE.

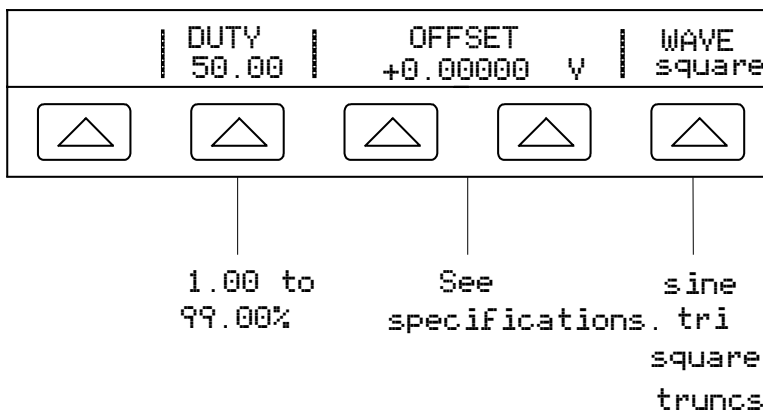



- **DUTY** (Duty Cycle) When the squarewave is selected, DUTY appears, allowing you to modify the duty cycle of the squarewave. The range is 1.00 to 99.00%. The default is 50.00%. The duty cycle must be 50.00% if you want to enter an OFFSET (see below).
- **OFFSET** (Voltage Offset) Appears when the desired output is less than 33V (sinewaves), 65 V (squarewaves) or 93 V (trianglewaves and truncated sinewaves). This softkey allows you to add a positive or negative dc offset voltage to the ac output signal. See “Entering a DC Offset” later in this chapter for more information. When a voltage output is expressed in dBm, voltage offset is not available. You can enter an offset for a squarewave output only when the duty cycle is 50.00% (see DUTY above).
- **WAVE** (Waveform) Allows you to select one of four different types of waveforms: sinewave, trianglewave, squarewave, and truncated sinewave. (See “Waveform Types” later in this chapter for more information). Whenever a non-sinusoidal waveform is selected, the Output Display shows P<sub>p</sub> (peak-to-peak). Waveform is not available for a sinewave output in dBm instead of volts.

**4-23. Setting DC Current Output**

Complete the following procedure to set a dc current output at the 5500A front panel AUX terminals (or 5725A Amplifier BOOST terminals if a 5725A is connected). If you make an entry error, press **CE** to clear the display, then reenter the value.

1. Press **RESET** to clear any output from the 5500A.
2. Connect the UUT as described earlier in this chapter under “Connecting the Calibrator to a UUT.”
3. Set the UUT to measure dc current on the desired range.
4. Press the numeric keys and decimal point key to enter the desired current output (maximum six numeric keys). For example, 234.567.
5. Press **+/-** to select the polarity of the current (default is +).
6. Press a multiplier key, if necessary. For example, press **<sup>μ</sup>m**.
7. Press **<sup>w</sup>A**
8. The Control Display now shows the amplitude of your entry. For example, 234.567 mA (below).

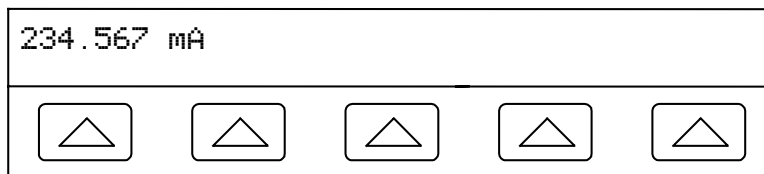

9. Press **ENTER**. The calibrator clears your entry from the Control Display and copies it into the Output Display (below is typical).

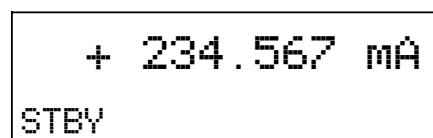

10. Press **OPR** to activate the calibrator output.

Several softkey labels appear on the Control Display in the dc current function: OUTPUT if an auxiliary amplifier is connected to the calibrator, and a Range softkey.

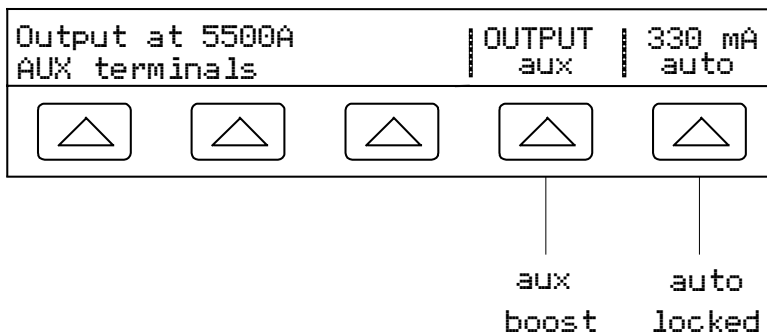

- **OUTPUT** (Output Location) Selects the current output terminals from the 5500A Calibrator (aux) and 5725A Amplifier (boost). If an external 5725A Amplifier is not connected, the OUTPUT softkey label will not appear in the display.
- **Range** (Operating Range) Selects autorange (auto) or lock (locked) for the present range. When auto (the default setting) is selected, the calibrator automatically selects the range that provides the best output resolution. When locked is selected, the calibrator will not change ranges when you are editing the output. The locked selection is usually made when you do not want range changes that may cause a small perturbation in the output, e.g., when checking the linearity of a given multimeter range.

#### 4-24. Setting AC Current Output

Complete the following procedure to set an ac current output at the 5500A front panel AUX terminals (or 5725A Amplifier BOOST terminals if a 5725A is connected). If you make an entry error, press **CE** to clear the display, then reenter the value.

1. Press **RESET** to clear any output from the 5500A.
2. Connect the UUT as described earlier in this chapter under “Connecting the Calibrator to a UUT.”
3. Set the UUT to measure ac current on the desired range.
4. Press the numeric keys and decimal point key to enter the desired current output (maximum six numeric keys). For example, 123.456.
5. Press a multiplier key, if necessary. For example, press  **$\mu$  m**.
6. Press  **$\mu$  A**.
7. The Control Display now shows the amplitude of your entry. For example, 123.456 mA (below).

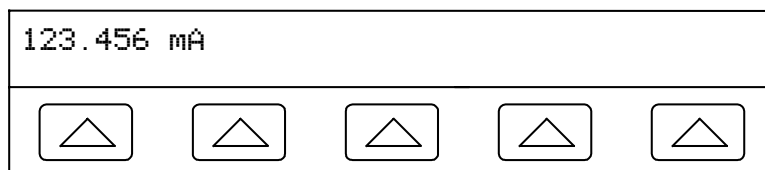

- Press the numeric keys and decimal point key to enter the desired frequency output (maximum five numeric keys). Press a multiplier key, if necessary. For example, press the kilo multiplier key  $\text{K}$ . Then press the  $\text{Hz}$  key. For example, 1.1234 kHz (below).

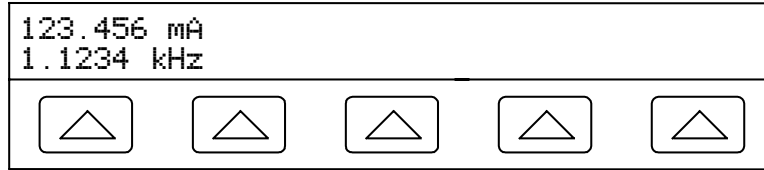

- Press  $\text{ENTER}$ . The calibrator clears your entry from the Control Display and copies it into the Output Display (below is typical).

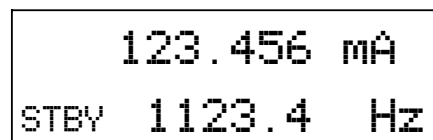

- Press  $\text{OPR}$  to activate the calibrator output.

Several softkey labels appear on the Control Display in the ac current function, depending on the 5500A configuration: OUTPUT and WAVE.

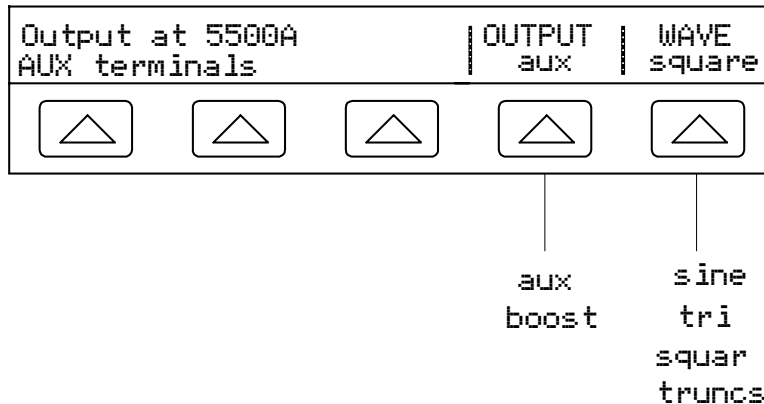

- OUTPUT** (Output Location) Selects the current output terminals between the 5500A Calibrator (aux) and 5725A Amplifier (boost). If a 5725A Amplifier is not connected, the OUTPUT softkey label will not appear in the display.
- WAVE** (Waveform) Allows you to select one of four different types of waveforms: sinewave, trianglewave, squarewave, and truncated sinewave. (See "Waveform Types" later in this chapter for more information). Whenever a non-sinusoidal waveform is selected, the Output Display will convert the RMS reading to peak-to-peak ( $P_p$ ).

## 4-25. Setting DC Power Output

### Note

Tie the terminals NORMAL LO and AUX LO together at the UUT or at the 5500A, via the “LO”s softkey selection “tied.”

The calibrator produces a dc power output by sourcing a dc voltage on the NORMAL outputs and a dc current on the AUX outputs. Complete the following procedure to set a dc power output. If you make an entry error, press **CE** one or more times to clear the display, then reenter the value.

### Caution

**Verify the applied voltage to the UUT does not exceed the rating of the UUT insulation.**

1. Press **RESET** to clear any output from the 5500A.
2. Connect the UUT as described earlier in this chapter under “Connecting the Calibrator to a UUT” by adapting the voltage and current connections.
3. Set the UUT to measure dc power on the desired range.
4. Press the numeric keys and decimal point key to enter the desired voltage output (maximum seven numeric keys). For example, 123.4567.

### Note

At voltage outputs of 100 volts and above (nominal), you may notice a slight high-pitched sound. This is normal.

5. Press **+/-** to select the polarity of the voltage (default is +).
6. Press a multiplier key, if necessary. For example, press  **$\mu$  m**.
7. Press  **$\text{dBm}$  V**.
8. The Control Display now shows the amplitude of your entry. For example, 123.4567 mV (below).

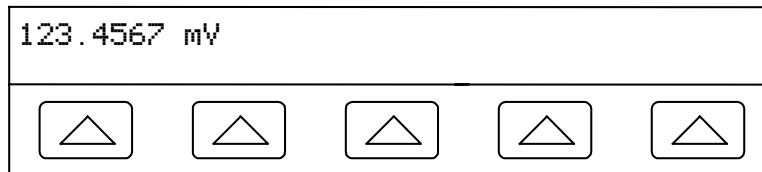

9. Press the numeric keys and decimal point key to enter the desired current output (maximum six numeric keys). For example, 234.567.
10. Press **+/-** to select the polarity of the current (default is +).
11. Press a multiplier key, if necessary. For example, press  **$\mu$  m**.
12. Press  **$\text{W}$  A**.
13. The Control Display now shows the amplitude of your entries. For example, 123.4567 mV and 234.567 mA (below).

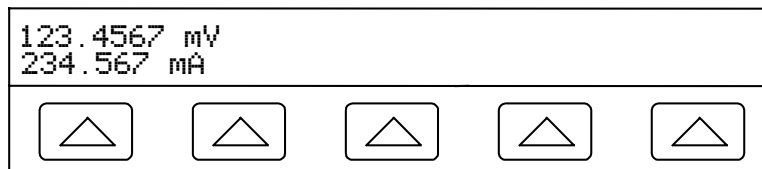

14. Press **ENTER**. The calibrator clears your entry from the Control Display and copies it into the Output Display (below is typical).

```
+123.4567 mV
STBY +234.567 mA
```

15. Press **OPR** to activate the calibrator output. When changing power output levels, you must reenter both voltage and current (in either order).

(Hint: Enter voltage *or* current and then a watts entry value using **SHIFT** **W A**. The remaining volts or current value is calculated and displayed.)

Two softkey labels appear on the Control Display: I OUT and “LO”s.

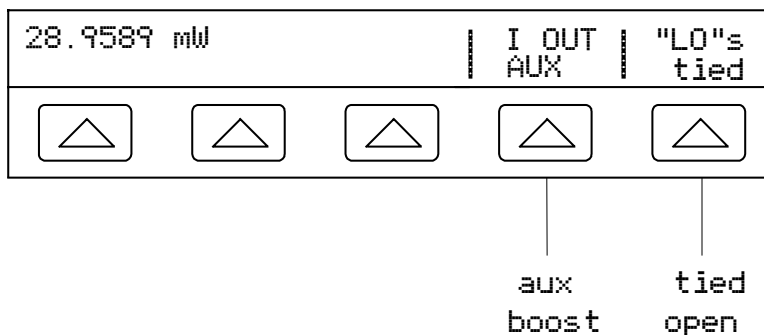

- **I OUT** (Current Output) Selects the current output between the 5500A Amplifier (aux) and 5725A Amplifier (boost). If a 5725A Amplifier is not connected, AUX will be in all capital letters and the softkey will have no function.
- **“LO”s** (Low Potential Output Terminals) The front panel NORMAL LO and AUX LO terminals must be tied together either at the UUT or at the 5500A. When the front panel NORMAL LO and AUX LO terminals are tied at the UUT, select “open” with the “LO”s softkey. If the NORMAL LO and AUX LO terminals are not tied at the UUT, select “tied” with the “LO”s softkey. The default is tied.

#### 4-26. Setting AC Power Output

*Note*

*Tie the terminals NORMAL LO and AUX LO together at the UUT, or at the 5500A via the “LO”s softkey selection “tied.” For optimum phase performance, tie the LO terminals at the UUT. At current levels  $\geq 2.2$  A, tie the terminals at the UUT using heavy gauge wire  $< 10$  m $\Omega$  resistance.*

The calibrator produces an ac power output by sourcing an ac voltage on the NORMAL outputs and an ac current on the AUX outputs.

See “Setting AC Voltage Output” above for information on selecting an ac voltage output in dBm; this procedure assumes an ac voltage output in volts.

Complete the following procedure to set an ac power output. If you make an entry error, press **CE** one or more times to clear the display, then reenter the value.

### Caution

**Verify the applied voltage to the UUT does not exceed the rating of the UUT insulation.**

1. Press **RESET** to clear any output from the 5500A.
2. Connect the UUT as described earlier in this chapter under “Connecting the Calibrator to a UUT.” (Adapt the voltage and current connections to suit your application.)
3. Set the UUT to measure ac power on the desired range.
4. Press the numeric keys and decimal point key to enter the desired voltage output (maximum six numeric keys). For example, 123.456.

### Note

*At voltage outputs of 100 volts and above (nominal), you may notice a slight high-pitched sound. This is normal.*

5. Press a multiplier key, if necessary. For example, press  **$\mu$  m**.
6. Press  **$\text{dBm V}$** .
7. The Control Display now shows the amplitude of your voltage entry. For example, 123.456 mV (below).

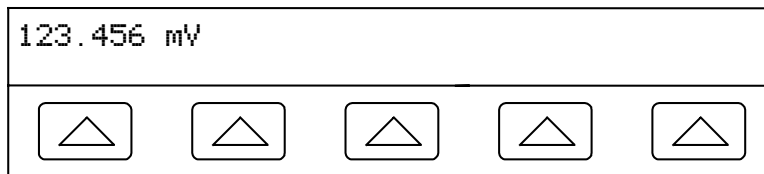

8. Press the numeric keys and decimal point key to enter the desired current output (maximum six numeric keys). For example, 234.567.
9. Press a multiplier key, if necessary. For example, press  **$\mu$  m**.
10. Press  **$\text{w A}$** .
11. The Control Display now shows the amplitude of your voltage and current entries. For example, 123.456 mV and 234.567 mA (below).

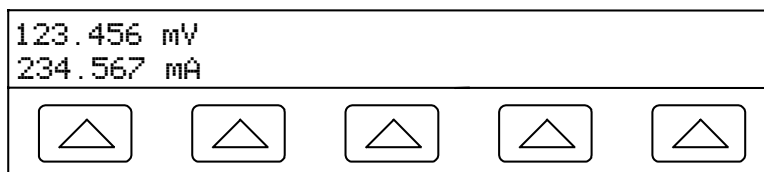

12. Press the numeric keys and decimal point key to enter the desired frequency output (maximum five numeric keys). Press a multiplier key, if necessary. For example, press the kilo multiplier key  **$\text{n K}$** . Then press the  **$\text{Hz}$**  key. For example, 1.1234 kHz.

13. The Control Display now shows your entries. For example, 123.456 mV and 234.567 mA at 1.1234 kHz (below).

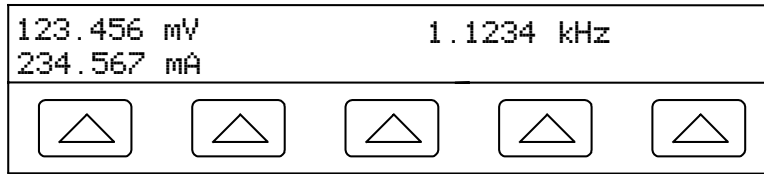

14. Press **ENTER**. The calibrator clears your entry from the Control Display and copies it into the Output Display (below is typical).

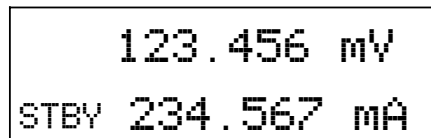

15. Press **OPR** to activate the calibrator output. When changing power output levels, you must reenter both voltage and current (in either order).

(Hint: Enter voltage *or* current and then a watts entry value using **SHIFT** **W A**. The remaining volts or current value is calculated and displayed.)

Two softkey labels appear on the Control Display: I OUT and WAVE MENUS. The Control Display also shows the real power output for sinewaves. Power out is computed as  $\text{Power} = \text{Cosine } \Phi (\text{Volts} \times \text{Current})$  where  $\Phi$  is the phase difference between the volts and current waveforms. Cosine  $\Phi$  is also known as the Power Factor (PF).

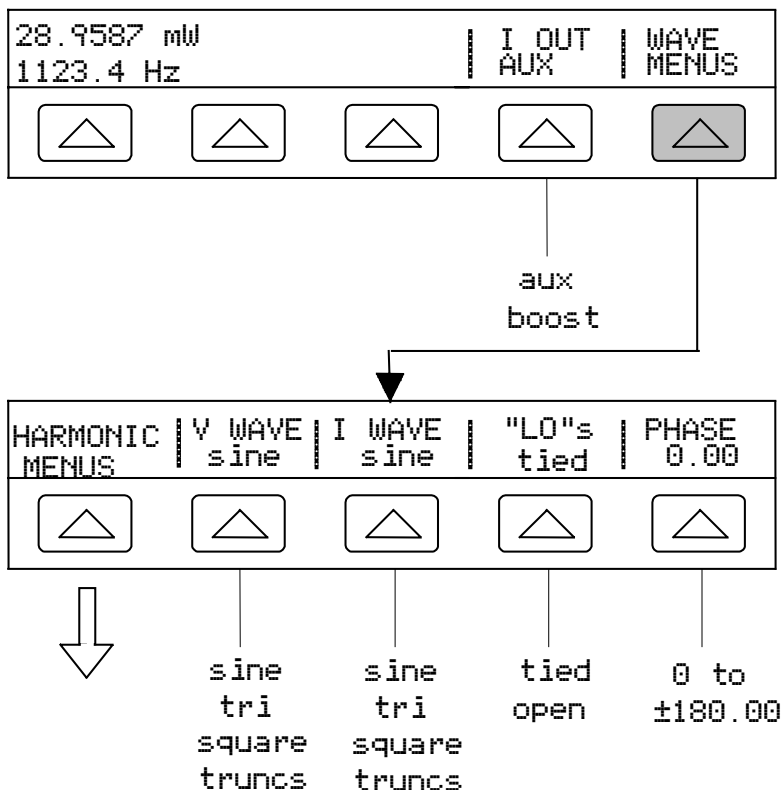

- **I OUT** (Current Output) Selects the current output between the 5500A Amplifier (aux) and 5725A Amplifier (boost). If a 5725A Amplifier is not connected, AUX will be in all capital letters and the softkey will have no function.
- **WAVE MENU** (Waveform Menu) Opens submenus for selecting the type of harmonic, waveform, front panel LO terminal condition, and phase.
  - **HARMONIC MENU** (Harmonic Frequency Menu) Opens submenus for selecting harmonic outputs. See “Setting Harmonics” later in this chapter.
  - **V WAVE** (Voltage Waveform) Selects the waveform for the voltage output at the NORMAL terminals. See “Waveform Types” later in this chapter.
  - **I WAVE** (Current Waveform) Selects the waveform for the current output at the front panel AUX terminals. See “Waveform Types” later in this chapter.
  - **“LO”s** (Low Potential Output Terminals) The front panel NORMAL LO and AUX LO terminals must be tied together either at the UUT or at the 5500A. When tied at the UUT, select “open.” The default is tied.
  - **PHASE** (Phase Difference) Selects the phase difference between the NORMAL and AUX outputs. See “Adjusting the Phase” later in this chapter.

#### 4-27. Setting a Dual DC Voltage Output

*Note*

*Tie the terminals NORMAL LO and AUX LO together at the UUT or at the 5500A, via the “LO”s softkey selection “tied.”*

The calibrator produces a dual dc voltage output by sourcing one dc voltage on the NORMAL outputs and a second on the AUX terminals. Complete the following procedure to set a dual dc voltage output. If you make an entry error, press **CE** one or more times to clear the display, then reenter the value.

#### Caution

**Verify the applied voltage to the UUT does not exceed the rating of the UUT insulation.**

1. Press **RESET** to clear any output from the 5500A.
2. Connect the UUT as described earlier in this chapter under “Connecting the Calibrator to a UUT.”
3. Set the UUT to measure dual dc voltage on the desired range.
4. Press the numeric keys and decimal point key to enter the desired voltage output at the NORMAL terminals (maximum seven numeric keys). For example, 123.4567.
5. Press **+/-** to select the polarity of the voltage (default is +).
6. Press a multiplier key, if necessary. For example, press **m**.
7. Press **<sup>dBm</sup>V**.
8. The Control Display now shows the amplitude of your entry for the NORMAL terminals. For example, 123.4567 mV (below).

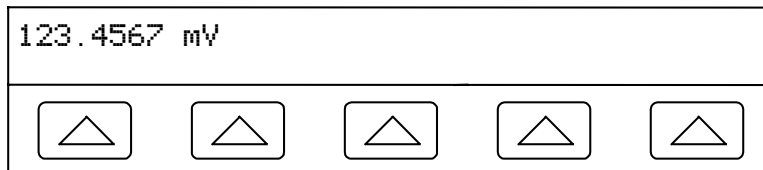



*Note*

*Voltage on the AUX output is limited to 3.3 V maximum.*

9. Press the numeric keys and decimal point key to enter the desired voltage output at the AUX terminals (maximum six numeric keys). For example, 234.567.
10. Press **+/-** to select the polarity of the voltage (default is +).
11. Press a multiplier key, if necessary. For example, press **μm**.
12. Press **dBmV**.
13. The Control Display now shows the amplitude of your entries for the NORMAL terminals (upper reading) and AUX terminals (lower reading) (see below).

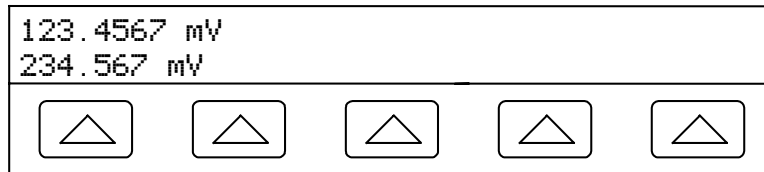

14. Press **ENTER**. The calibrator clears your entry from the Control Display and copies it into the Output Display (below is typical).

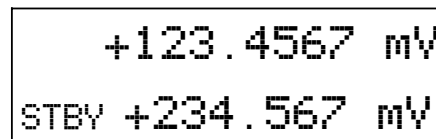

15. Press **OPR** to activate the calibrator output.  
A softkey labeled "LO"s appears on the Control Display.

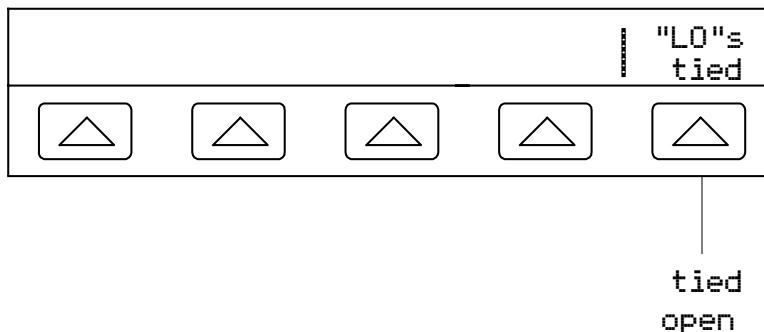

- **“LO”s (Low Potential Output Terminals)** The front panel NORMAL LO and AUX LO terminals must be tied together either at the UUT or at the 5500A. When the front panel NORMAL LO and AUX LO terminals are tied at the UUT, select “open” with the “LO”s softkey. If the NORMAL LO and AUX LO terminals are not tied at the UUT, select “tied” with the “LO”s softkey. The default is tied.

#### 4-28. Setting a Dual AC Voltage Output

*Note*

*Tie the terminals NORMAL LO and AUX LO together at the UUT or at the 5500A, via the “LO”s softkey selection “tied.”*

The calibrator produces a dual ac voltage output by sourcing one ac voltage on the NORMAL outputs and a second on the AUX terminals. See “Setting AC Voltage Output” above for information on selecting an ac voltage output in dBm.

Complete the following procedure to set a dual ac voltage output. If you make an entry error, press **CE** one or more times to clear the display, then reenter the value.

#### Caution

**Verify the applied voltage to the UUT does not exceed the rating of the UUT insulation.**

1. Press **RESET** to clear any output from the 5500A.
2. Connect the UUT as described earlier in this chapter under “Connecting the Calibrator to a UUT.”
3. Set the UUT to measure dual ac voltage on the desired range.
4. Press the numeric keys and decimal point key to enter the desired voltage output at the NORMAL terminals (maximum six numeric keys). For example, 123.456.
5. Press a multiplier key, if necessary. For example, press  **$\mu$  m**.
6. Press  **$\text{dBmV}$** .
7. The Control Display now shows the amplitude of your voltage entry. For example, 123.456 mV (below).

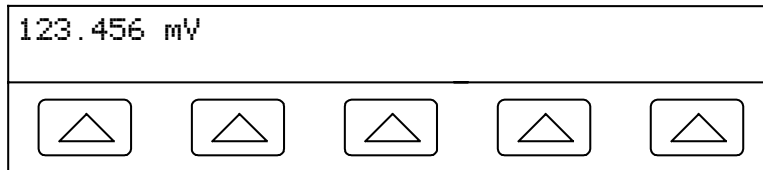

*Note*

*The AUX output is limited to 3.3 V rms for sinewaves, 6.6 V peak-to-peak for squarewaves, 9.3 V peak-to-peak for triangle and truncated sinewaves.*

8. Press the numeric keys and decimal point key to enter the desired voltage output at the AUX terminals (maximum six numeric keys). For example, 234.567.
9. Press a multiplier key, if necessary. For example, press  **$\mu$  m**.
10. Press  **$\text{dBmV}$** .
11. The Control Display now shows the amplitude of your entries for the NORMAL terminals (upper reading) and AUX terminals (lower reading) (below is typical).

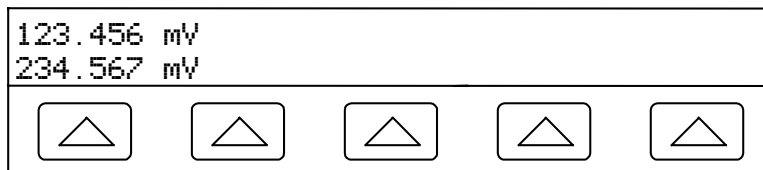

12. Press the numeric keys and decimal point key to enter the desired frequency output (maximum five numeric keys). Press a multiplier key, if necessary. For example, press the kilo multiplier key **[K]**. Then press the **[Hz]** key. For example, 1.1234 kHz.
13. The Control Display now shows your voltage and frequency entries. For example, 123.456 mV and 234.567 mV at 1.1234 kHz (below).

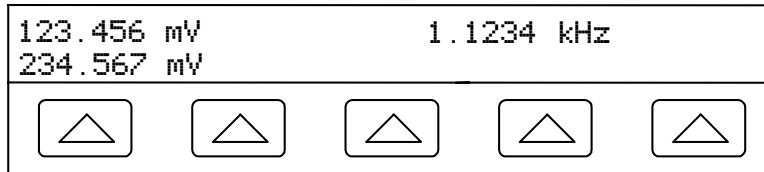

14. Press **[ENTER]**. The calibrator clears your entry from the Control Display and copies it into the Output Display (below is typical).

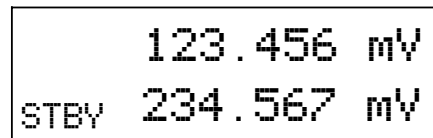

15. Press **[OPR]** to activate the calibrator output.

Two softkey labels appear on the Control Display: V@NOR/V@AUX and WAVE MENUS.

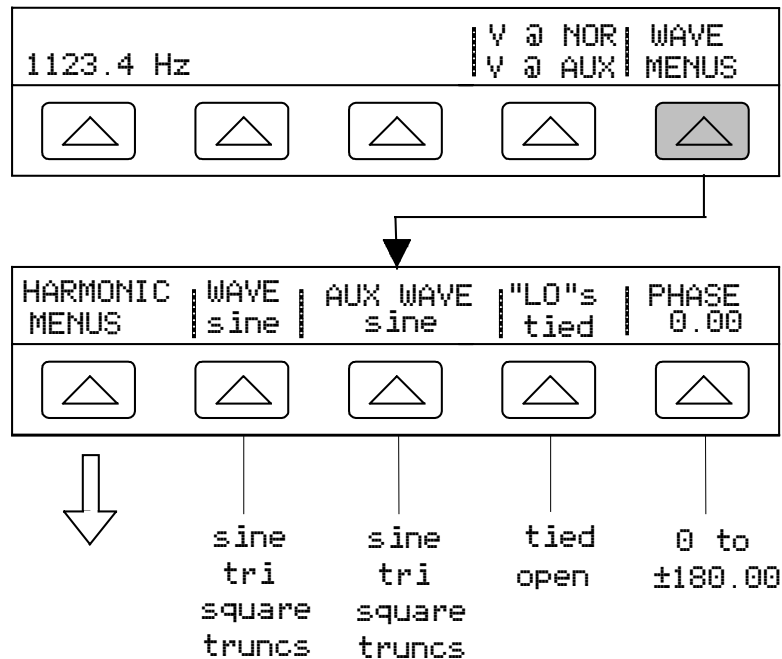

- **V @ NOR** (Voltage at NORMAL Terminals) **V @ AUX** (Voltage at AUX Terminals) This is an information-only softkey position and does not have an associated function. It shows the output function is dual ac voltage.

- **WAVE MENUS** (Waveform Menus) Opens submenus for selecting the type of harmonic, waveform, front panel LO terminal condition, and phase.
  - **HARMONIC MENUS** (Harmonic Frequency Menus) Opens submenus for selecting harmonic outputs. See “Setting Harmonics” later in this chapter for more information.
  - **WAVE** (Normal Waveform) Selects the waveform for the voltage at the front panel NORMAL terminals. See “Waveform Types” later in this chapter for more information.
  - **AUX WAVE** (Auxiliary Waveform) Selects the waveform for the voltage at the front panel AUX terminals. See “Waveform Types” later in this chapter for more information.
  - **“LO”s** (Low Potential Output Terminals) The front panel NORMAL LO and AUX LO terminals must be tied together either at the UUT or at the 5500A. When the front panel NORMAL LO and AUX LO terminals are tied at the UUT, select “open” with the “LO”s softkey. If the NORMAL LO and AUX LO terminals are not tied at the UUT, select “tied” with the “LO”s softkey. The default is tied.
  - **PHASE** (Phase Difference) Selects the phase difference between the NORMAL and AUX outputs. See “Adjusting the Phase” later in this chapter for more information.

#### 4-29. **Setting Resistance Output**

Complete the following procedure to set a synthesized resistance output at the 5500A front panel NORMAL terminals. If you make an entry error, press **CE** to clear the display, then reenter the value.

1. Press **RESET** to clear any output from the 5500A.
2. Connect the UUT as described earlier in this chapter under “Connecting the Calibrator to a UUT.”

*Note*

*Since this is a synthesized output, be sure the terminal connections from the 5500A to the UUT are LO to LO and HI to HI.*

3. Set the UUT to measure resistance on the desired range.
4. Press the numeric keys and decimal point key to enter the desired resistance output (maximum six numeric keys). For example, 12.3456.
5. Press a multiplier key, if necessary. For example, press  **$10^3$  K**.
6. Press  **$\Omega$** .
7. The Control Display now shows the amplitude of your resistance entry. For example, 12.3456 k $\Omega$  (below).

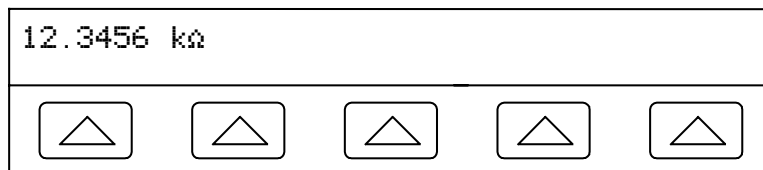

- Press **ENTER**. The calibrator clears your entry from the Control Display and copies it into the Output Display (below is typical).



- Press **OPR** to activate the calibrator output.

The softkeys allow selection of three lead-compensation settings and ohms zero.

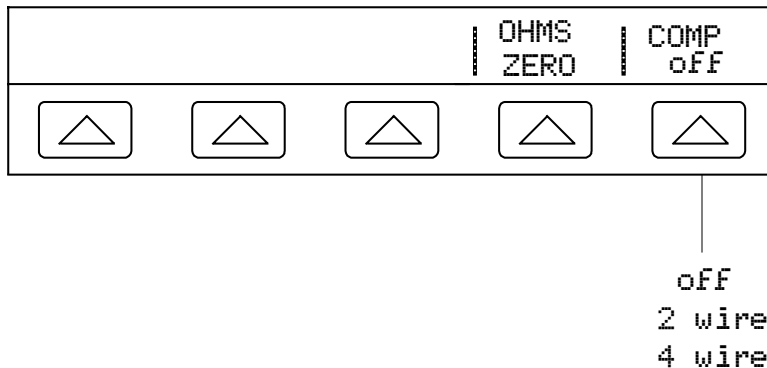

- **OHMS ZERO** Press to recalibrate internal circuitry for the ohms function (allow several minutes).
- **COMP** (Compensation) Applies 4-wire compensation, 2-wire compensation or turns compensation off. Compensation is available for resistances up to (but not including) 110 kΩ. See “Four-wire versus Two-wire Connections” earlier in this chapter for more information.

### 4-30. Setting Capacitance Output

Complete the following procedure to set a synthesized capacitance output at the front panel NORMAL terminals. If you make an entry error, press **CE** to clear the display, then reenter the value.

- Press **RESET** to clear any output from the 5500A.
- Connect the UUT as described earlier in this chapter under “Connecting the Calibrator to a UUT.” Also refer to “Cable Connection Instructions” for a procedure to null out stray capacitances due to the test cable connections.

*Note*

*Since this is a synthesized output, be sure the terminal connections from the 5500A to the UUT are LO to LO and HI to HI.*

- Set the UUT to measure capacitance on the desired range.
- Press the numeric keys and decimal point key to enter the desired capacitance output (maximum five numeric keys). For example, 123.45.
- Press a multiplier key (preceded with the **SHIFT** key) for the desired output. For example, press **SHIFT** then **μ m** for μf. The other multiplier keys include **° M** for pf and **° K** for nf.
- Press **F ±**.

7. The Control Display now shows the amplitude of your capacitance entry. For example, 123.45  $\mu\text{F}$  (below).

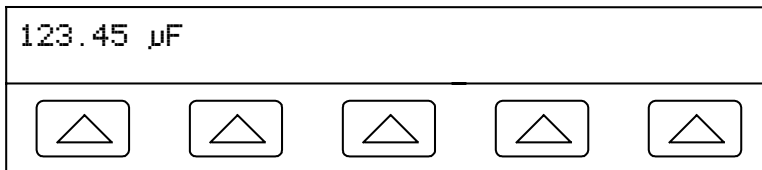

8. Press **ENTER**. The calibrator clears your entry from the Control Display and copies it into the Output Display (below is typical).

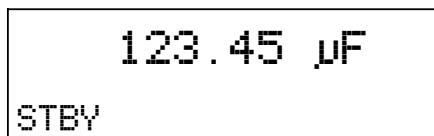

9. Press **OPR** to activate the calibrator output.

The softkey in the Control Display labeled COMP allows you to select one of three lead-compensation settings.

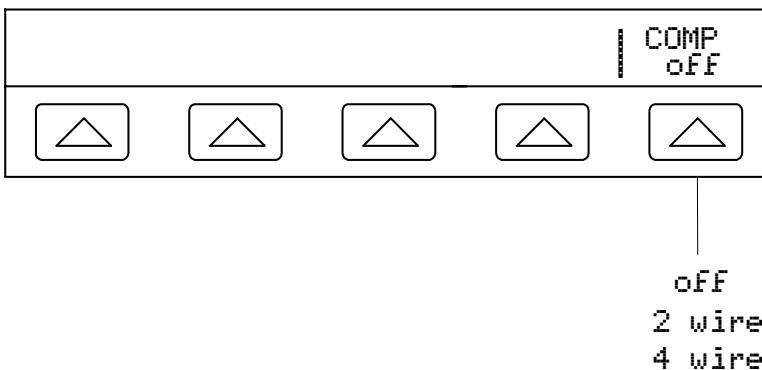

- **COMP** (Compensation) Applies 4-wire compensation, 2-wire compensation or turns compensation off. Compensation refers to methods of connecting the 5500A to the UUT to cancel out test lead resistance (NOT capacitance). Compensation is available for capacitances of 110 nf and above. This softkey will not function below 110 nf. See “Four-wire versus Two-wire Connections” earlier in this chapter for more information.

### 4-31. Setting Temperature Simulation (Thermocouple)

*Note*

*Make sure the thermocouple wire and plug are not affected by extraneous temperature sources. For example, do not place your fingers on the thermocouple plug or wire when simulating a temperature.*

Thermocouples generate a small dc voltage at specific temperatures. The simulated output, therefore, is a small dc voltage based on the selected temperature and type of thermocouple being simulated. To toggle the temperature reference between the 1968 International Provisional Temperature Standard (ipts-68) and the 1990 International Temperature Standard (its-90), see “Using the Instrument Setup Menu.”

Complete the following procedure to set a simulated thermocouple temperature output at the 5500A front panel TC connector. If you make an entry error, press **CE** to clear the display, then reenter the value.

1. Press **RESET** to clear any output from the 5500A.
2. Connect the UUT as described earlier in this chapter under “Connecting the Calibrator to a UUT.”

*Note*

*You must use thermocouple wire and miniconnectors that match the type of thermocouple. For example, if simulating a temperature output for a K thermocouple, use K-type thermocouple wire and K-type miniconnectors.*

3. Set the UUT to measure temperature on the desired range.
4. Press the numeric keys and decimal point key to enter the desired temperature output (maximum 6 numeric keys). For example, 123.456.
5. For an output in °C, press the **°C** key. For an output in °F, press **SHIFT** and then the **°C** key.
6. The Control Display now shows the amplitude of your temperature output. For example, 123.456 °C (below).

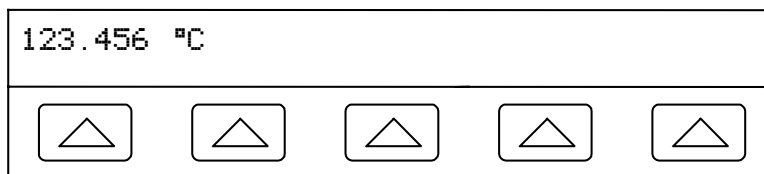

7. Press **ENTER**. The calibrator clears your entry from the Control Display and copies it into the Output Display (below is typical).

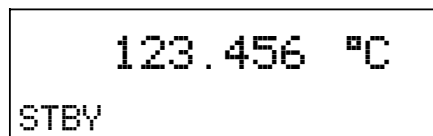

8. Press **OPR** to activate the calibrator output. Four softkey labels appear on the Control Display.

Note

The entered temperature will be cleared to 0 °C (32 °F) if you change between tc and rtd, or change the type of thermocouple (except for a B-type thermocouple, which clears to 600 °C). If this should occur, select OUTPUT tc, the desired thermocouple TYPE, and then reenter the temperature.

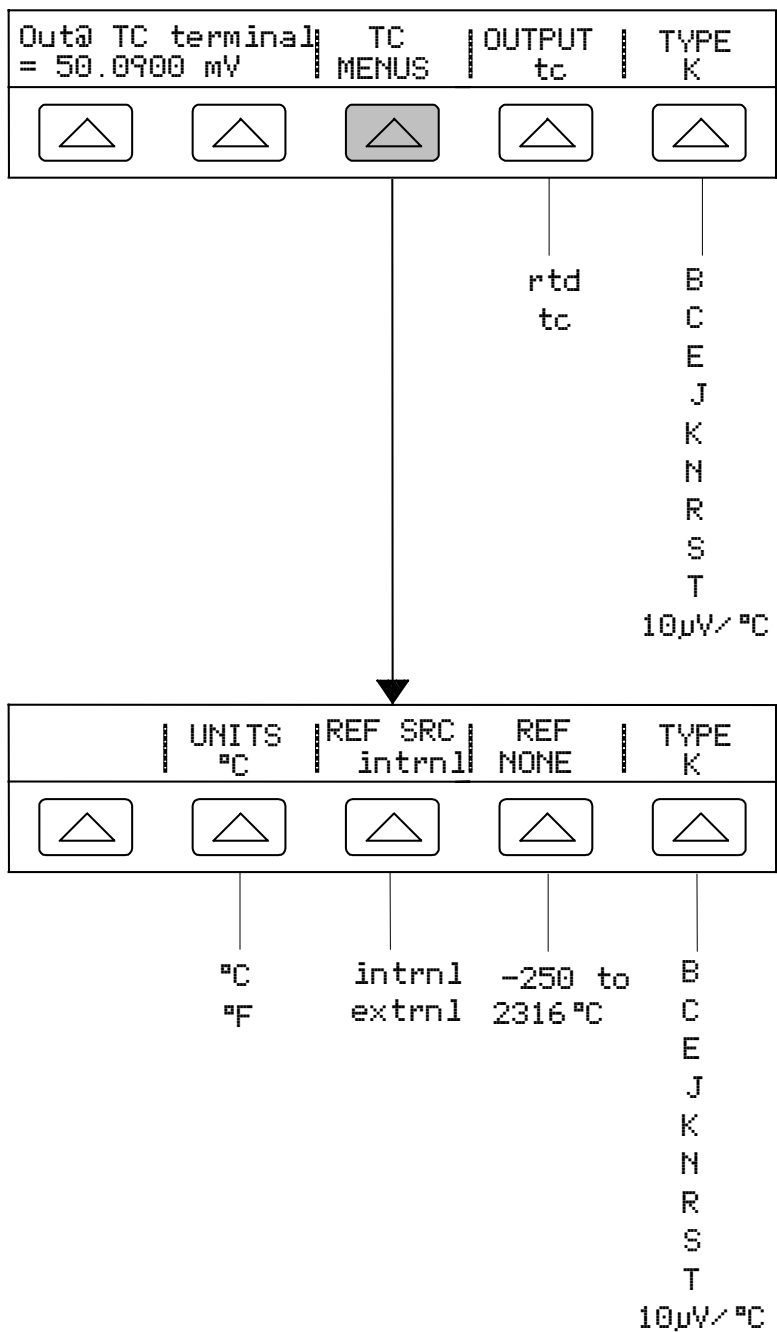

- **Out@TC terminal** (Output at the front panel TC terminals) Displays the actual dc voltage at the front panel TC terminals. This is a display only, not a softkey function.
- **TC MENUS** (Thermocouple Menu) Shows submenus for thermocouple outputs.



- **UNITS** (Temperature Units) Selects °C or °F as the temperature unit.
- **REF SRC** (Reference Source) Selects intrnl (Internal) or extrnl (External) temperature reference source. Select intrnl when the selected thermocouple has alloy wires and you are using the isothermal block internal to the 5500A Calibrator. Select extrnl when using an external isothermal block, and when the selected thermocouple has copper wires. Press the REF softkey to enter the value of the external temperature reference. The best accuracy is obtained when you use extrnl and the external isothermal block is maintained at 0°C.
- **REF** (Temperature Reference) Displays the value of the temperature reference. When the Reference Source is Internal, the display shows the internal reference, or NONE if the 5500A is in Standby. When the Reference Source is External, the display shows the value you entered for external reference.
- **TYPE** (Thermocouple Type) Selects the thermocouple type emulated by the 5500A Calibrator. The default is K. (The 10 µV/°C setting is used as an accurate output voltage source for customer-supplied linearizations.)
- **OUTPUT** (Temperature Output Device) Selects the temperature device: thermocouple (tc) or resistance temperature detector (rtd). Select tc.
- **TYPE** (Thermocouple Type) Selects the thermocouple type emulated by the 5500A Calibrator. The default is K. (The 10 µV/°C setting is used as an accurate output voltage source for customer-supplied linearizations.)

Note: The “u” indicator that occasionally appears in the Output Display indicates an internal adjustment to the measured isothermal block temperature and is normal. If it appears for more than 10 seconds (nominal), or if it appears to flash continuously, check to see that you are not externally heating the thermocouple miniconnector or wires.

#### **4-32. Setting Temperature Simulation (RTD)**

RTDs have a characteristic resistance at specific temperatures. The simulated output, then, is a resistance value based on the selected temperature and type of RTD being simulated. To toggle the degree reference between the 1968 International Provisional Temperature Standard (ipts-68) and the 1990 International Temperature Standard (its-90), see “Using the Instrument Setup Menu” earlier in this chapter.

Complete the following procedure to set a simulated RTD temperature output at the 5500A front panel NORMAL terminals. If you make an entry error, press **CE** to clear the display, then reenter the value.

1. Press **RESET** to clear any output from the 5500A.
2. Connect the UUT as described earlier in this chapter under “Connecting the Calibrator to a UUT.”

*Note*

*When calibrating Resistance Temperature Detectors (RTDs) using the three-terminal connection shown in Figure 4-9, be sure the test leads have identical resistances to cancel any errors due to lead resistance. This can be accomplished, for example, by using three identical test lead lengths and identical connector styles.*

3. Set the UUT to measure temperature on the desired range.
4. Press the numeric keys and decimal point key to enter the desired temperature output (maximum 6 numeric keys). For example, 123.456.
5. For an output in °C, press the **°C** key. For °F, press **SHIFT** and then the **°C** key.

6. The Control Display now shows the amplitude of your temperature output. For example, 123.456°C (below).

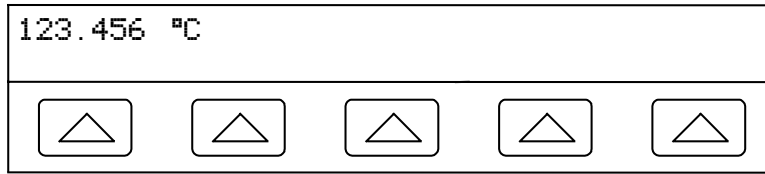

7. Press **ENTER**. The calibrator clears your entry from the Control Display and copies it into the Output Display (below is typical).

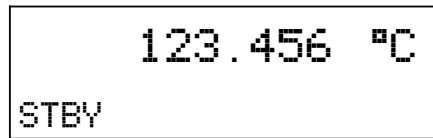

8. Press **OPR** to activate the calibrator output.

Four softkey labels appear on the Control Display. Press the OUTPUT softkey to toggle the rtd selection, displaying the rtd setup menu and four softkey positions.

*Note*

*The temperature you entered above will be cleared to 0°C (32°F) if you change between tc (thermocouple) and rtd (resistance temperature detector), or change the type of rtd. If this occurs, select OUTPUT rtd, the desired rtd TYPE, and then reenter the temperature following steps 4 to 8.*

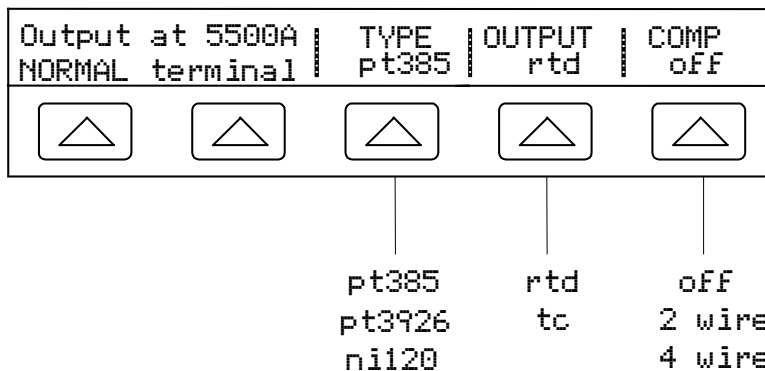

- **Output at 5500A NORMAL terminal.** Displays the location of the output terminals (always NORMAL) for rtd connections.
- **TYPE (RTD Type)** Selects the rtd curve pt385 (curve,  $\alpha = 0.00385$  ohms/ohm/°C), pt3926 (curve,  $\alpha = 0.003926$  ohms/ohm/°C), or ni120 (empirical curve).
- **OUTPUT (Temperature Output Device)** Selects the temperature device: thermocouple (tc) or resistance temperature detector (rtd). Select rtd.
- **COMP (Compensation)** Applies 4-wire compensation, 2-wire compensation or turns compensation off. Compensation refers to methods of connecting the 5500A to the UUT to cancel out test lead resistance. See "Four-wire versus Two-wire Connections" earlier in this chapter for more information. For the 3-lead connection (Figure 4-9) select COMP off.

**4-33. Measuring Thermocouple Temperatures**

Complete the following procedure to measure the output of a thermocouple connected to the TC input. If you make an entry error, press **CE** to clear the display, then reenter.

1. Press **RESET** to clear any output from the 5500A.
2. Connect the thermocouple to the front panel TC connector.

*Note*

*Use thermocouple wire and miniconnectors that match the type of thermocouple. For example, K-type wire and K-type miniconnectors.*

3. Press **MEAS<sub>TC</sub>** to display the TC menus (below).

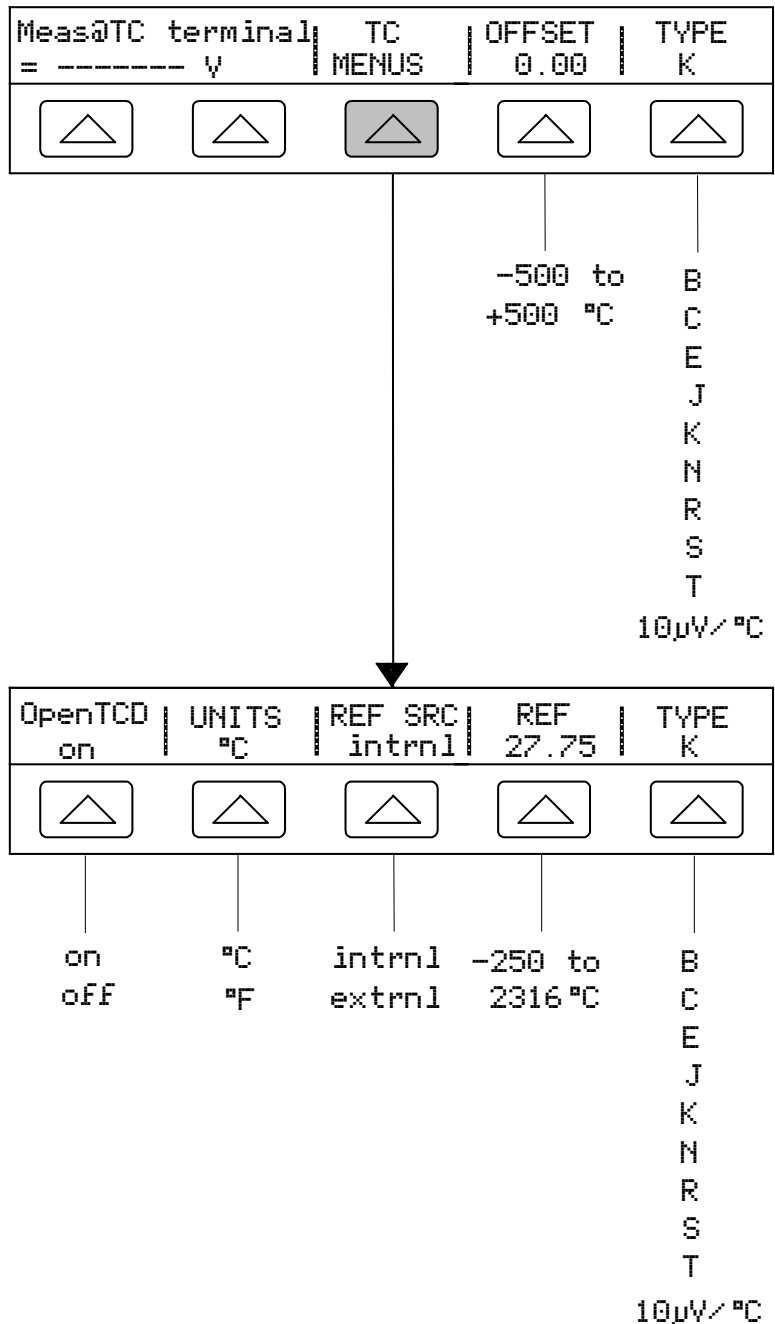

- The measured temperature appears in the Output Display (below is typical). (The lower-case m blinks on when a measurement is being taken.)

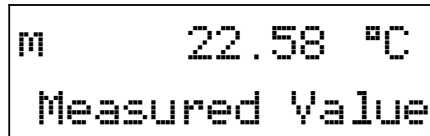

```
m 22.58 °C
Measured Value
```

- **Meas@TC terminal** (Measurement at the front panel TC terminals) Displays the actual dc voltage at the front panel TC terminals. This is a display only, not a softkey function.
- **TC MENUS** (Thermocouple Menus) Opens the submenus supporting thermocouple outputs.
  - **Open TCD** (Open Thermocouple Detect) Selects on or off for the Open TCD feature. When Open TCD is on, a small electrical pulse checks for thermocouple continuity that, in most cases, will have no effect on the measurement. If you are measuring the thermocouple with the 5500A Calibrator in parallel with another temperature measuring device, select off for Open TCD. When an open thermocouple is detected, “Open TC” is displayed in the TC menu, providing positive identification of the fault.
  - **UNITS** (Temperature Units) Selects °C or °F as the temperature unit.
  - **REF SRC** (Reference Source) Selects intrnl (Internal) or extrnl (External) temperature reference source. The reference source indicates the ambient temperature contribution to the thermocouple output, which is taken into account when simulating an accurate temperature output. Select intrnl when the selected thermocouple has alloy wires and you are using the isothermal block internal to the 5500A Calibrator. Select extrnl when using an external isothermal block, and when the selected thermocouple has copper wires. Press the REF softkey to enter the value of the external temperature reference.
  - **REF** (Temperature Reference) Displays the value of the temperature reference. When the Reference Source is Internal, the display shows the internal reference. When the Reference Source is External, the display shows the value you entered for external reference.
  - **TYPE** (Thermocouple Type) Selects the thermocouple type used for measurement.. The default is K. (The 10µV/°C setting is used for customer-supplied linearizations.)
- **OFFSET** (Measurement Display Offset) Selects an offset value to be added or subtracted from the actual measurement. This is useful for differential measurements (temperatures above and below a desired temperature).
- **TYPE** (Thermocouple Type) Selects the thermocouple type used for measurement.. The default is K. (The 10µV/°C setting is used for customer-supplied linearizations.)

## 4-34. Waveform Types

AC voltage, ac current, dual ac voltage, and ac power functions provide a softkey to select between four different waveform types: sinewave (sine), trianglewave (tri), squarewave (square), and truncated sinewave (truncs). When the calibrator output is sinewave ac power or dual ac voltage, the Control Display shows additional softkeys for harmonics and fundamental frequencies.

**4-35. Sinewave**

When the wave selection is sine, a sinewave current or voltage signal is present on the calibrator outputs (Figure 4-11). The variables for the sinewave are amplitude, frequency, and dc offset voltage.

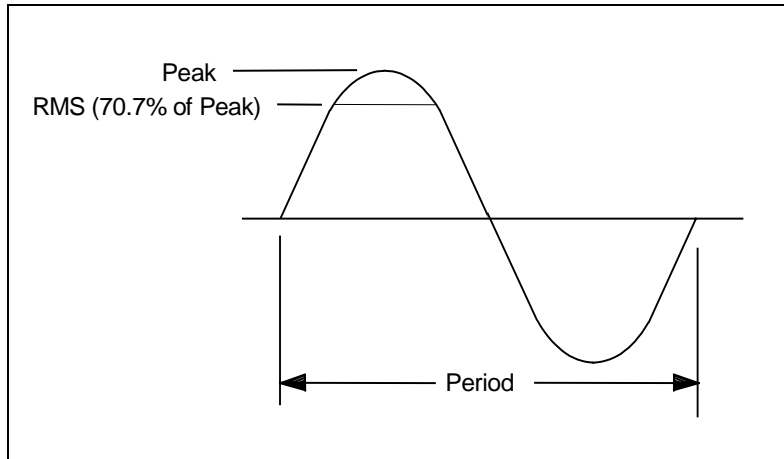

**Figure 4-11. Sinewave**

**4-36. Trianglewave**

When the wave selection is tri, the trianglewave is present on the calibrator outputs (Figure 4-12). The variables for the trianglewave are amplitude, frequency, and dc offset voltage. Whenever a trianglewave is selected, the Output Display indicates amplitudes in peak-to-peak units.

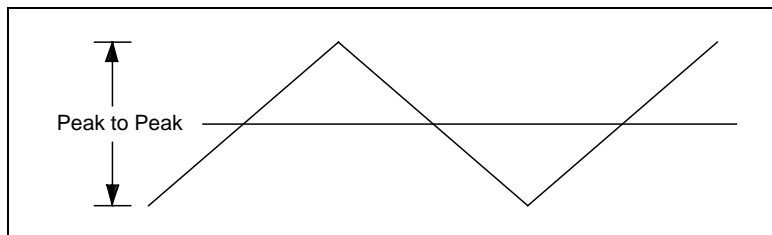

**Figure 4-12. Trianglewave**

**4-37. Squarewave**

When the wave selection is square, a squarewave current or voltage signal is present on the calibrator outputs (Figure 4-13). The variables for the squarewave are duty cycle, amplitude, frequency, and dc offset voltage. Whenever a squarewave is selected, the Output Display indicates amplitude in peak-to-peak units. If the calibrator is set for a single voltage or current output, the duty cycle of the signal can be set through the keypad. To enter a new duty cycle, press the DUTY CYCLE softkey and up to five numeric keys followed by **ENTER**. The negative-going edge of the squarewave will move based on the duty cycle setting.

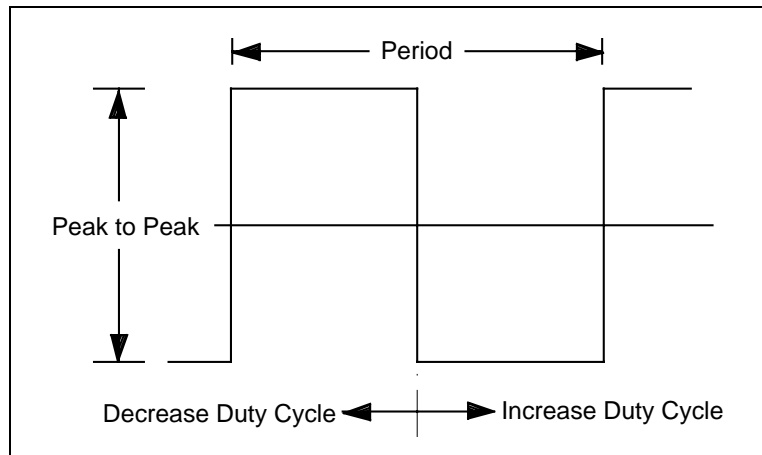

Figure 4-13. Squarewave and Duty Cycle

#### 4-38. Truncated Sinewave

When the wave selection is trunks, a truncated sinewave current or voltage signal is present on the calibrator outputs (Figure 4-14). The variables for the truncated sinewave are amplitude and frequency. Whenever a truncated sinewave is selected, the Output Display indicates amplitudes in peak-to-peak units.

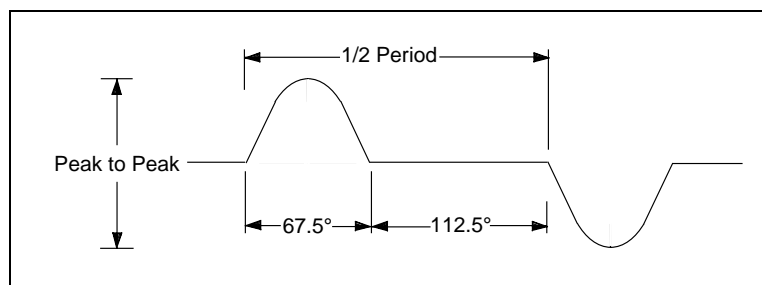

Figure 4-14. Truncated Sinewave

#### 4-39. Setting Harmonics

When the calibrator is outputting dual ac voltages or ac power (sinewaves only), the calibrator sources two signals with adjustable harmonic difference, with a maximum harmonic frequency output of 10 kHz. For example, a 120 V, 60 Hz signal can be set on the front panel NORMAL terminals, and a 1 V, 300 Hz (5th harmonic) output on the AUX terminals. The fundamental can be configured on either the NORMAL or the AUX terminals, with the harmonic output on the opposite terminals. Note that the maximum AUX output is 3.3 V, while the maximum NORMAL output is 1000 V. Unless both the fundamental and harmonic frequencies are allowed for the given amplitude, the output is not allowed.

Complete the following procedure to enter a harmonic output. This procedure assumes you have already sourced a dual ac voltage or ac power output.

1. Press the softkey WAVE MENUS, opening the waveform menu.
2. Press the softkey HARMONIC MENUS, opening the harmonic submenu (below is typical).

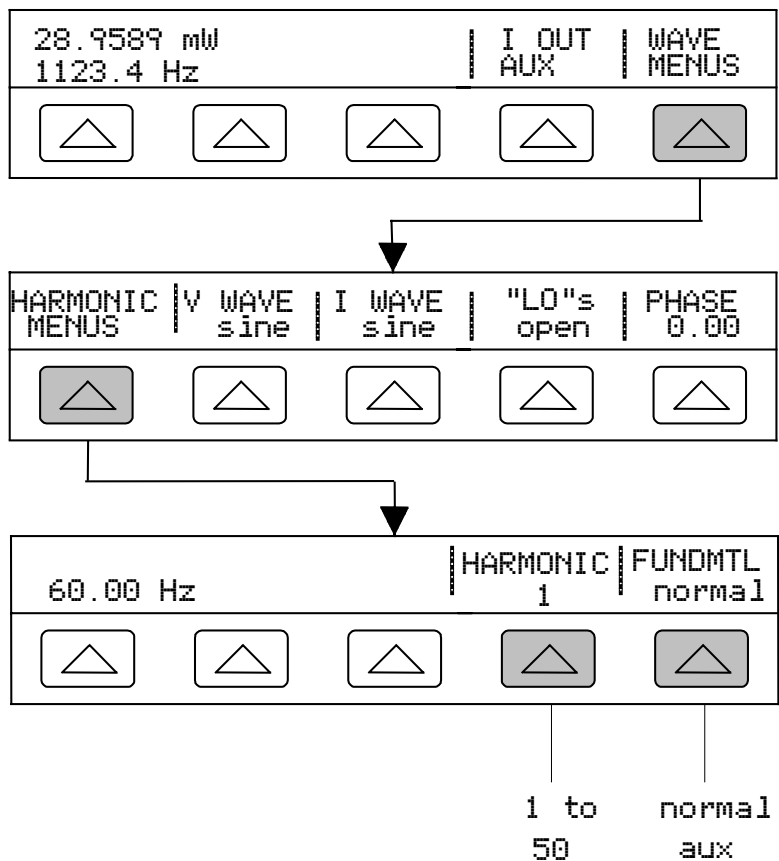

3. Press the softkey FUNDMTL to select the 5500A Calibrator front panel terminals for the fundamental output, either NORMAL or AUX. If sourcing an output on the 5725A Amplifier, the choices are NORMAL or BOOST, where boost is the 5725A Amplifier terminals. The harmonic appears on the 5500A AUX terminals.
4. Press the softkey HARMNIC to enter the desired harmonic (1 to 50), with a maximum frequency output of 10 kHz.. For example, entering the 7th harmonic (below). When the control display shows the desired value, press **ENTER** .

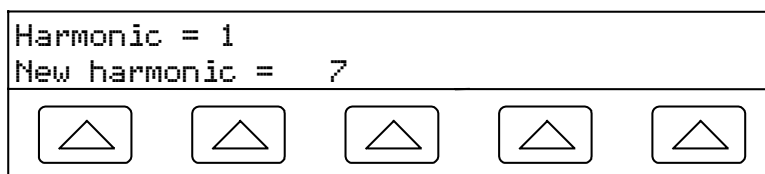

5. Press **PREV MENU** one or more times to return to previous menus.

### 4-40. Adjusting the Phase

When in the dual ac voltage and ac power output modes, you can set the calibrator to source two signals with adjustable phase difference. All phase adjustments shift the AUX waveform in relation to the NORMAL waveform. Phase shift adjustments are entered into the calibrator either as degrees (0 to  $\pm 180.00$ ) or as a power factor (PF). A leading or positive phase shift will cause the AUX waveform to lead the NORMAL waveform; a lagging or negative phase shift will cause the AUX waveform to lag the NORMAL waveform.

The softkey PHASE is available after pressing the WAVE MENUS softkey that appears when outputting dual ac voltages or ac power (shown below for ac power output).

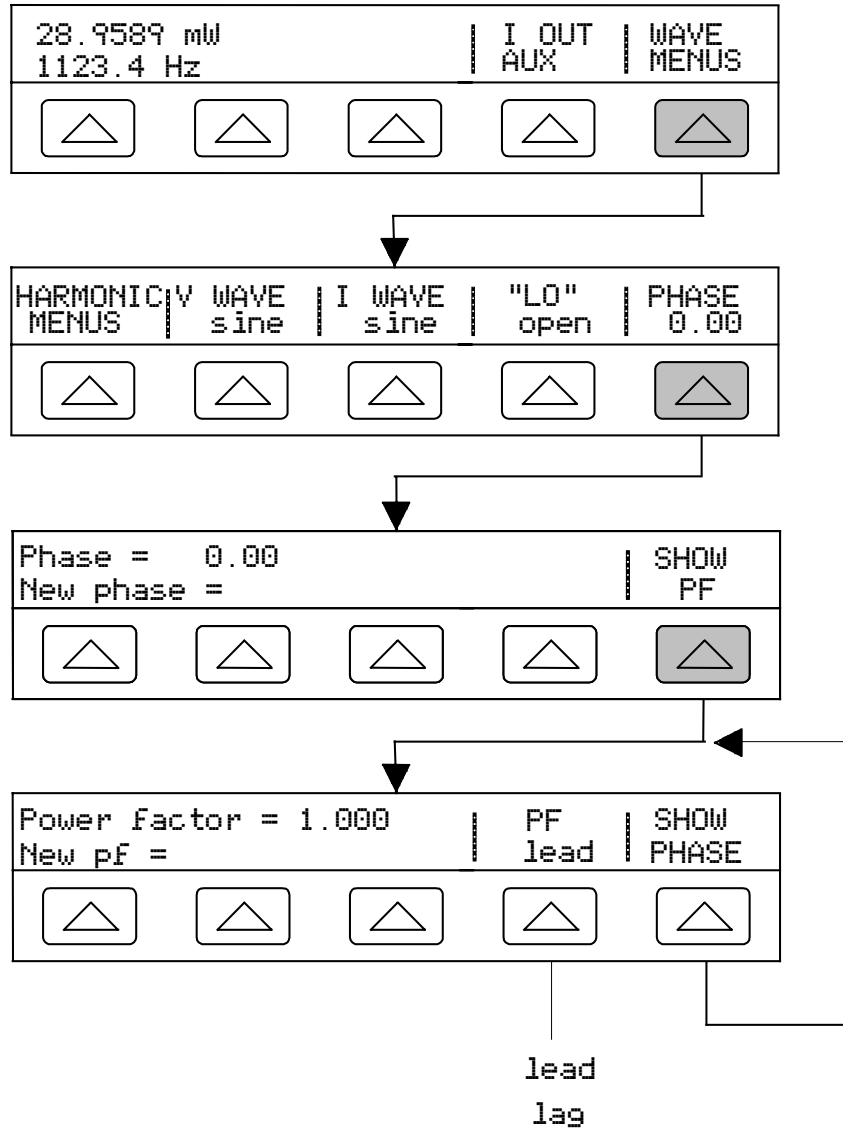

When one output is a harmonic of the other, the phase shift is based on the phase angle or power factor (cosine) of the harmonic signal. For example, when the AUX output is generating a 60-Hz signal, and the NORMAL output is generating a 120-Hz (2nd Harmonic) signal, a phase shift of 60° (pf of .5) would move the AUX signal 60° of 120-Hz (30° of 60 Hz).

#### 4-41. Entering a Phase Angle

Complete the following procedure to enter a phase shift in degrees. This procedure assumes you have already sourced a dual ac voltage or ac power output.

1. Press the softkey WAVE MENUS, opening the waveform menu.
2. Press the softkey PHASE, opening the phase entry menu.



3. Press the numeric keys and decimal point key to enter the desired phase angle (maximum five numeric keys). For example, 123.45.
4. Press **+/-** to select leading (+) or lagging (-) phase shift (default is +).
5. The Control Display now shows the value of your entry. For example, a leading phase angle of 123.45 degrees (below). (SHOW PF appears only for sinewaves.)

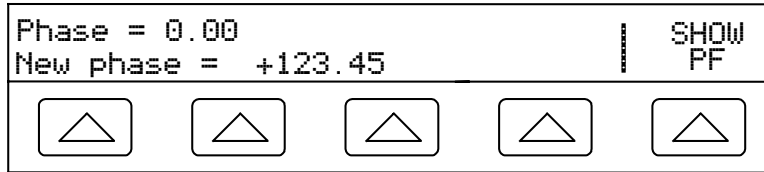

6. Press **ENTER**. The calibrator clears your entry from the “New phase =” line and copies it to the “Phase =” line of the Control Display.
7. Press **PREV MENU** one or more times to return to previous menus.

#### 4-42. Entering a Power Factor

Complete the following procedure to enter a phase shift as a power factor (PF). PF = Cosine  $\Phi$ , where  $\Phi$  is the phase shift. This procedure assumes you have already sourced a dual ac voltage or ac power output using sinewaves as the waveform.

1. Press the softkey WAVE MENUS, opening the waveform menu.
2. Press the softkey PHASE, opening the phase entry menu.
3. Press the softkey SHOW PF, opening the power factor entry menu.
4. Press the decimal point key and numeric keys to enter the desired power factor (maximum three numeric keys). For example, .678.
5. Press the softkey PF to toggle between a leading (lead) or lagging (lag) power factor (default is lead).
6. The Control Display now shows the value of your entry. For example, a leading power factor of .678 (below).

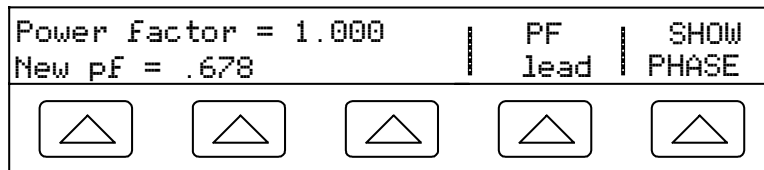

7. Press **ENTER**. The calibrator clears your entry from the “New pf =” line and copies it to the “Power Factor =” line of the Control Display.
8. Press **PREV MENU** one or more times to return to previous menus.

## 4-43. Entering a DC Offset

When the calibrator single output is an ac voltage of sinewaves, trianglewaves, squarewaves or truncated sinewaves, you can apply a  $\pm$ dc offset. When applying an offset to squarewave outputs, the duty cycle must be 50.00% (default). The offset selection is entered using the softkey OFFSET, which appears when the ac voltage output is less than 33 V (sinewaves), 66 V peak-to-peak (squarewaves) or 93 V peak-to-peak (trianglewaves and truncated sinewaves). The softkey OFFSET will not appear and offsets may not be entered when the output is a voltage sinewave measured in dBm.

The maximum offset value allowed depends on the maximum offset and maximum peak signal for each range. For example, a squarewave output of 10 V peak-to-peak is within the range 6.6 to 65.9999 V peak-to-peak, a range that allows a maximum peak signal of 55 V. For this example, the squarewave peak value is 5 V, thus allowing a maximum  $\pm$ offset of 50 V for a maximum peak signal of 55 V.

Check the specifications in Chapter 1 for offset limits. If you are using an offset voltage and you cause the output to move into a range where offset is not allowed (for example, above 33 V for a sinewave output), the calibrator will go into the standby mode and the offset function will be disabled.

Complete the following procedure to enter a dc voltage offset. If you make an entry error, press **CE** to clear the display, then reenter the value. This procedure assumes you have already sourced a single ac voltage output not exceeding 33 V (sinewaves), 65 V peak-to-peak (squarewaves) or 93 V peak-to-peak (trianglewaves and truncated sinewaves), thus displaying the softkey OFFSET (below).

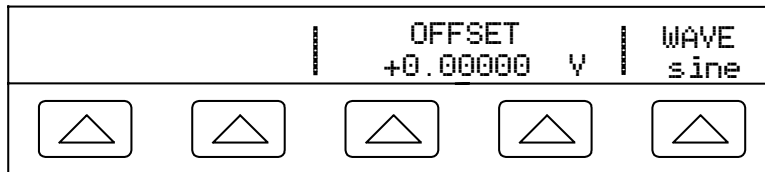

1. Press the softkey WAVE to select the desired waveform: sinewaves (sine), trianglewaves (tri), squarewaves (square) or truncated sinewave (truncs).
2. Press the softkey OFFSET, opening the offset entry display. Enter the desired offset using the numeric keys and decimal point key. For example, 0.123 V (below).

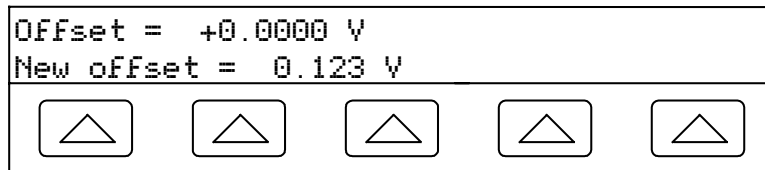

3. Press the **ENTER** key to enter the offset and then **PREV MENU**.

## 4-44. Using the 5725A Amplifier

The 5725A Amplifier increases the current and voltage bandwidth, and drive capability of the 5500A Calibrator. The 5725A Amplifier has separate voltage boost and current boost amplifiers, however, only one boost function can be used at any one time. When operated in dual output modes such as ac power, the 5725A Amplifier can supply one output, while the 5500A Calibrator supplies the other output.

In the voltage boost mode, the 5725A output appears on the 5500A Calibrator NORMAL terminals. In the current boost mode, the 5725A output appears on the 5725A CURRENT OUTPUT terminals. You can also redirect 5500A current to the 5725A output terminals; 0 - 2.2 A dc, and 300  $\mu$ A - 2.2 A ac. The Output Display on the 5500A always shows the actual output of the amplifier, not the excitation output of the 5500A.

### Rules of Operation

- Whenever the 5500A Calibrator front panel **BOOST** key annunciator is on, either the 5725A voltage boost amplifier or current boost amplifier is in use. The 5725A Amplifier front panel indicators identify which amplifier is operating.
- If the 5725A Current Amplifier indicator is on, while the 5500A **BOOST** annunciator is off, 5500A current is being directed to the 5725A terminals. During this condition, both the 5725A voltage boost and current boost amplifiers are disabled.
- When sourcing current, the output softkey choice AUX (5500A) or BOOST (5725A) takes precedence over the Source Preference softkey and the front panel **BOOST** key. Exception: When the selected current cannot be sourced by the 5500A (e.g., 10 A, 15 kHz), the output automatically switches to BOOST and displays error 540 in the Control Display (Current OUTPUT moved to 5725A).
- The Source Preference softkey in the SETUP menu chooses the 5500A Calibrator or 5725A Amplifier when either can source the selected output. The **BOOST** key is a temporary Source Preference selection. Toggling **BOOST** on sets the Source Preference to the 5725A. Toggling **BOOST** off sets the Source Preference to the 5500A. Pressing **RESET** reestablishes the default Source Preference stored in the non-volatile memory.
- Any current or voltage combination that is outside the capabilities of the 5500A Calibrator but within the capabilities of the 5725A Amplifier, will automatically activate the 5725A Amplifier output.

### Examples

- Selecting a 5725A Amplifier boost current between 1.5 - 2.19999 A:
  - Enter the desired current.
  - Select boost with the OUTPUT softkey.
  - Verify source preference is 5725.
  - Verify the **BOOST** annunciator is on.
  - The boost current appears on the 5725A CURRENT OUTPUT terminals.
- Selecting a 5725A Amplifier boost current  $\geq$  2.2 A:
  - Enter the desired current.
  - Select boost with the OUTPUT softkey.
  - (Source preference unimportant)
  - Verify the **BOOST** annunciator is on (and cannot be toggled off)
  - The boost current appears on the 5725A CURRENT OUTPUT terminals.

- Selecting a 5725A Amplifier boost voltage between 100 - 1000 V (within the 5500A Calibrator frequency capabilities):
  - Enter the desired voltage.
  - Verify source preference is 5725.
  - Verify the **BOOST** annunciator is on.
  - The boost voltage appears on the 5500A front panel NORMAL terminals.
- Selecting a 5725A Amplifier boost current (1.5 - 2.19999 A) and a 5500A Calibrator voltage (100 - 1000 V):
  - Enter the desired current and voltage.
  - Select boost with the I OUT softkey.
  - Verify source preference is 5725.
  - Verify the **BOOST** annunciator is on.
  - The boost current appears on the 5725A CURRENT OUTPUT terminals.
  - The voltage appears on the 5500A front panel NORMAL terminals.
- Selecting a 5725A Amplifier boost voltage (100 - 1000 V) and any 5500A current:
  - Enter the desired current and voltage.
  - Select aux with the I OUT softkey.
  - Verify source preference is 5725.
  - Verify the **BOOST** annunciator is on.
  - The boost voltage appears on the 5500A front panel NORMAL terminals.
  - The current appears on the 5500A front panel AUX terminals.
- Selecting a 5500A Calibrator current and directing it to the 5725A Amplifier with any 5500A voltage:
  - Enter the desired current and voltage.
  - Select boost with the I OUT softkey.
  - Verify source preference is 5500.
  - Verify the **BOOST** annunciator is off.
  - The 5500A current appears on the 5725A CURRENT OUTPUT terminals.
  - The 5500A voltage appears on the 5500A front panel NORMAL terminals.

#### 4-45. 5725A Amplifier Output



**Boosted voltage operation produces high voltage at higher current levels than normally available from the calibrator. During boosted voltage operation, the potential risk of injury or fatal accident is greater than during normal operation.**

#### *Note*

*Refer to the 5725A Instruction Manual for setup and installation instructions.*

Proceed as follows to set a boosted output from the 5725A Amplifier:

1. Press **RESET** to clear any output from the 5500A.
2. Install the 5725A, as described in the 5725A Instruction Manual.
3. Connect the UUT as described earlier in this chapter under “Connecting the Calibrator to a UUT.” Note that for boosted current, you connect to the 5725A front panel terminals; for boosted voltage, you connect to the 5500A front panel NORMAL terminals.

4. Set the UUT to measure the output on the desired range.
5. Set the calibrator source preference to 5725: press the front panel **SETUP** key; softkey INSTMT SETUP; softkey OUTPUT SETUP; softkey SOURCE PREFERNCE to select 5725.
6. Press the **PREV MENU** key one or more times to return to a previous menu. When asked, press softkey STORE CHANGES or DISCARD CHANGES, as desired.
7. Enter the desired output value as described under “Setting the Output.”

*Note*

*You can have the 5725A source a dc current below 1.5 A to take advantage of the amplifier’s higher compliance voltage. To do so, press the RANGE softkey to lock onto the 11 A range when the 5500A is set for over 2.2 A, or set the lower current and press **BOOST** **OPR** to turn on the amplifier.*

8. Activate and deactivate the 5725A Amplifier by pressing the **BOOST** key. (See “Selecting an External Amplifier” earlier in this chapter.) When boost is selected, the boost key annunciator is on. If BOOST is not your default source preference, when you press the **RESET** key, the boost will be deactivated.

### 4-46. Editing and Error Output Settings



All 5500A Calibrator outputs can be edited using the front panel Edit Field knob and associated **◀**, **▶**, and **EDIT FIELD** keys. In addition, multiply **MULT X** and divide **DIV** keys edit the output by decades. The difference between the original output (reference) and edited output is displayed as an “error” between the two settings. This allows you to edit a value to achieve a correct reading at the UUT and thereby calculate an error in ±% or ppm (parts per million) if it is less than ±1000 ppm. Table 4-3 lists the actions that cause the calibrator to exit the error mode and return to the original reference output, or to output a new reference, as selected.

**Table 4-3. Keys That Exit Error Mode**

Keys	Action
<b>ENTER</b>	Returns to the previous reference value.
<b>+/-</b> + <b>ENTER</b>	Establishes a new reference.
A new keypad entry + <b>ENTER</b>	Establishes a new reference.
<b>NEW REF</b>	Establishes the present output as a new reference.
<b>MULT X</b>	Sets the calibrator to ten times the reference value and establishes a new reference.
<b>DIV</b>	Sets the calibrator to one-tenth the reference value and establishes a new reference.
<b>RESET</b>	Returns to the power-up state.

### 4-47. Editing the Output Setting

When you initially source an output from the Calibrator, you enter a specific value. For example, 10.00000 volts dc. To edit the output value to suit your application, turn the front panel Edit Field knob clockwise to increase the value or counter-clockwise to decrease the value. (The Edit Field controls will not operate if you are in any setup function. Press the **PREV MENU** key one or more times to exit a setup function.)

To select a higher order digit, use an Edit Field cursor key  or . The output digit in edit is always underlined (see below).

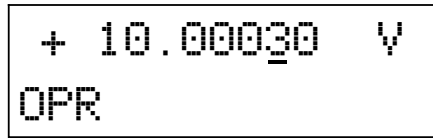

The momentary display of the letter u in the Output Display when editing during OPR (Operate) indicates “unsettled,” that is, the Calibrator output is settling with a new value.

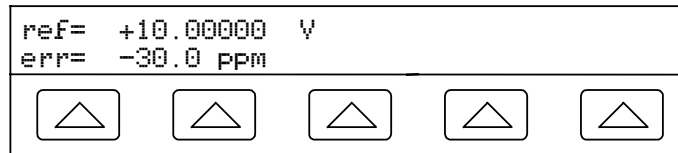

#### 4-48. *Displaying the Output Error*

When you edit the output value, the Control Display shows the difference between the reference value (the value you originally entered) and the edit value (the value shown in the Output Display), displaying error difference in parts per million (ppm). This allows you to edit the output such that the UUT displays the expected value and thus give an indication of the UUT accuracy.



For example, an edited difference of .00030 volts for an output of 10.00000 V represents  $.00030/10.00000 = .000030$ , or 30 parts per million. The sign is negative (-30.0 ppm) because the output necessary to display 10.00000 at the UUT shows the UUT is reading below the output value. When the reference is negative, the error sign is relative to the magnitude. For example, if the reference is -10.00000 V and the output display is -10.00030, the error is -30 ppm.

#### 4-49. *Using Multiply and Divide*

The 5500A output value (or reference value if you have edited the output) can be multiplied by a factor of 10 by pressing the  key. Similarly, the output value (or reference value if you have edited the output) can be divided a factor of 10 by pressing the  key. The output will be placed in STBY (Standby) if the multiplied value exceeds 33V. Press the  key if you wish to continue. This feature is useful for UUTs with ranges organized in decades.

#### 4-50. *Setting Output Limits*

An output limit feature is available to help prevent accidental damage to a UUT from overcurrent or overvoltage conditions. This feature allows you to preset the maximum positive and negative allowable voltage or current output. Entry limits you set prevent any output greater than the limit from being activated by entry through the front panel keys or the output adjustment controls. Positive limits for voltage and current set the limits for ac voltage and current. Your limit selections are saved in the nonvolatile memory. Voltage limits are expressed as rms values, and any voltage offsets are ignored.

**4-51. Setting Voltage and Current Limits**

To set voltage and current entry limits, proceed as follows:

1. Press **RESET** to clear any output from the 5500A.
2. Press **SETUP**. Press the softkey INSTMT SETUP to open the setup submenus.
3. Press the softkey OUTPUT SETUP to open the output setup submenus.
4. Press the softkey SET LIMITS to open the set limits menu (below).

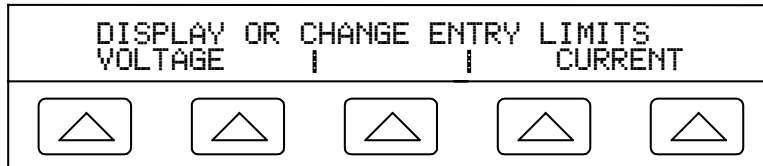

5. **To Limit Voltage** (applies to both dc and ac voltages) Press a softkey under VOLTAGE to open the voltage limits menu (below).

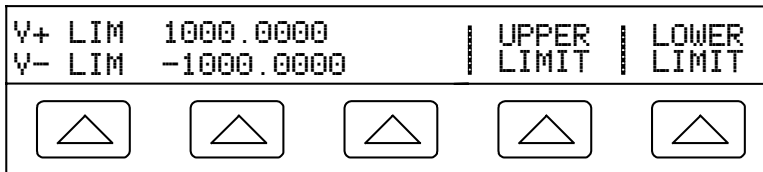

- a. Press the “Upper Limit” or the “Lower Limit” softkey, as desired, and enter the new limit.
  - b. Press **ENTER** then **PREV MENU** one or more times to return to a previous menu.
6. **To Limit Current** (applies to both dc and ac currents) Press a softkey under CURRENT to open the current limits menu (below).

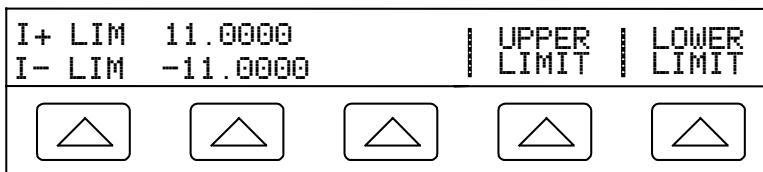

- a. Press the “Upper Limit” or the “Lower Limit” softkey, as desired, and enter the new limit.
- b. Press **ENTER** then **PREV MENU** one or more times to return to a previous menu.

## 4-52. Sample Applications

Samples of a few selected applications are provided here:

- Calibrating a Fluke 80 Series 3-1/2 digit handheld multimeter
- Calibrating a Fluke Model 41 Power Harmonics Analyzer for Power and Harmonics
- Calibrating a Fluke Model 51 Digital Thermometer

### 4-53. Calibrating an 80 Series Handheld Multimeter

This example goes through the steps necessary to calibrate a Fluke 80 Series handheld multimeter.

#### *Note*

*These procedures are included here as an example. The 80 Series Service Manual contains the authoritative testing and calibration procedures for 80 Series meters.*

Two procedures are provided. The first tests each function and range for compliance to specifications. The second is the calibration procedure for the 80 Series meters. The 80 Series Service Manual gives instructions for disassembly and access to the pca (printed circuit assembly). You will need to access the pca for the calibration procedure.

Before connecting the calibrator to the 80 Series DMM, you need to determine what type of cables to use and whether to use  or not. This decision-making process is covered next.

### 4-54. Cables

Fluke 5440A-7002 Low-Thermal Cables are recommended for many calibrations connections, but they are not specifically required for 80 Series calibration. Thermal emf errors that the Low-Thermal cables are designed to reduce are not significant when calibrating a 3-1/2 digit meter. The cables from the 5500A/LEADS set (PN 109949) are appropriate for the Fluke 80 Series. The cables support the following measurements:

- AC and dc voltages
- All resistances
- AC and dc currents up to 20 A

### 4-55. EARTH Connection

Because the 80 Series DMMs are battery operated, their inputs have no connection to earth ground. Therefore, enabling the calibrator's EARTH connection is appropriate.



**4-56. Testing the Meter**

You can use the error mode feature of the calibrator to test the meter. To verify that all ranges of all functions are within specifications, proceed as follows:

1. Turn on the calibrator and allow it to warm up.
2. Verify that the EARTH indicator is on; if not, press **EARTH** as necessary.

**⚠ ⚠ Warning**

**Ensure that the calibrator is in standby mode before making any connection between the calibrator and tester. Dangerous voltages may be present on the leads and connectors.**

3. Verify that the calibrator is in standby and connect the DMM as shown in Figure 4-15.

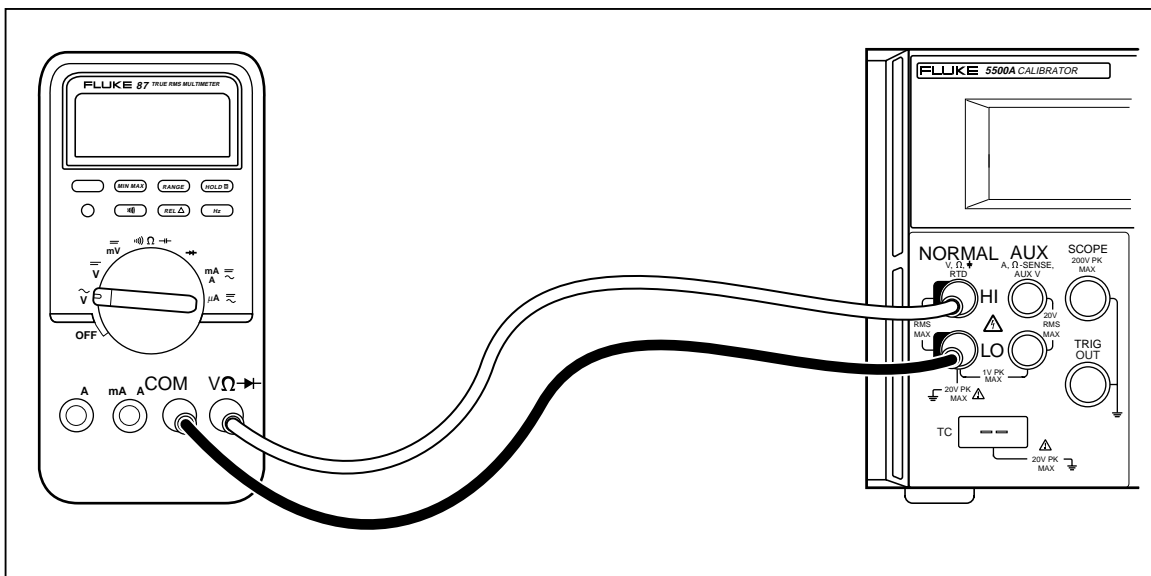

f4-15.eps

**Figure 4-15. Cable Connections for Testing an 80 Series General Functions**

4. Test the dc voltage function as follows:
  - a. Turn on the DMM and set its function switch to **V**.
  - b. Set the warmed up calibrator to 3.5 V dc. Press **OPR**.
  - c. Use the output adjustment controls to adjust the calibrator output for a reading of +3.5000 on the DMM display.
  - d. Verify that the error shown on the control display is less than the specification for the DMM in its Users Manual.
  - e. Check the DMM error at 35.0 V, -35.0 V, 350.0 V. Hint: use the **MULT X**. Verify the errors are within specification. When **MULT X** causes the output to go over 33 V, the calibrator goes into standby. When this happens, press **OPR** to operate.
  - f. Check the DMM error at 1000 V to verify it is within specification.
  - g. Set the output of the calibrator to 350 mV and press **OPR**. Verify the errors are within specifications.

5. Test the ac voltage function:

- a. Press **RESET** on the calibrator and set the DMM function switch to  $\tilde{V}$ .
- b. Set the output of the calibrator to 350 mV at 60 Hz. and press **OPR**. Verify the errors are within specifications.
- c. Check the error against specifications at the following voltages and frequencies:

Voltage	Frequency
350 mV	60 Hz, 5 kHz, & 20 kHz
3.500 V	60 Hz, 5 kHz, & 20 kHz
35.00 V	60 Hz, 5 kHz, & 20 kHz
329.0 V	60 Hz, 5 kHz, & 20 kHz
100.0 V	20 kHz
200.0 V	20 kHz
300.0 V	20 kHz
1000 V	60 Hz & 5 kHz

6. Test the Frequency function:

- a. Press **RESET** on the calibrator, set the DMM function switch to  $\tilde{V}$ , and press **Hz** on the DMM.
- b. Set the calibrator to 150 mV at 19.0 kHz and press **OPR**. Verify the error is within specification.
- c. Set the calibrator to 150 mV at 190 kHz. Hint: press **EDIT FIELD** twice to move the cursor to the frequency reading in the output display and press **MULT X**. Verify the error is within specification.

7. Test Frequency Sensitivity and Trigger Levels:

- a. Press **RESET** on the calibrator, set the DMM function switch to  $\tilde{V}$  and press **Hz** on the DMM to choose the frequency mode.
- b. Set the calibrator to 300 mV at 1 kHz and press **OPR**. Verify the frequency error is within specification.
- c. Change the calibrator output to 1.7 V. Verify the frequency error is within specification.
- d. Change the calibrator output to 1.0 V. Verify that the DMM displays 000.0 frequency.
- e. Change the DMM range to 40 V by pressing **RANGE**. Change the calibrator output to 6.0 V. Verify the frequency error is within specification.
- f. Change the calibrator output to 2.0 V. Verify that the DMM displays 000.0 frequency.

8. Test the Ohms function as follows:
  - a. Press **RESET** on the calibrator and set the DMM function switch to  $\Omega \rightarrow \rightarrow$ .
  - b. Set the calibrator to 190.0  $\Omega$  with 2-wire compensation (see Figure 4-2). Press **OPR**. Verify the error is within specifications.
  - c. Repeat the previous step for 19.00 k $\Omega$ , 1.900 M $\Omega$ , and 19.00 M $\Omega$ . Verify the errors are within specifications.
  - d. Press **RANGE** on the DMM to enter the 40-nanosiemen range, used for conductance tests of high resistances.
  - e. Set the calibrator output to 100 M $\Omega$ . Verify the error is within specification.
9. Test the capacitance function as follows (use the REL feature of the 80 Series to subtract cable capacitance):
  - a. Press **RESET** on the calibrator and set the DMM function switch to  $\Omega \rightarrow \rightarrow$  and press the blue button.
  - b. Set the calibrator output to 1.0  $\mu\text{F}$  with compensation off. Press **OPR**. Verify the error is within specification.
  - c. Repeat the previous step using 0.470  $\mu\text{F}$ , 0.047 $\mu\text{F}$ , and 4.70 nF. Verify the errors are within specifications.
10. Test the Diode Test function as follows:
  - a. Press **RESET** on the calibrator and set the DMM function switch to  $\rightarrow \rightarrow$ .
  - b. Set the calibrator to 3.0V dc and press **OPR**. Verify the error is within specification.
11. Test the ac and dc current function:
  - a. Press **RESET** on the calibrator and set the DMM function switch to mA  $\rightarrow \rightarrow$ .
  - b. Verify that the calibrator is in standby and connect the DMM as shown in Figure 4-16.

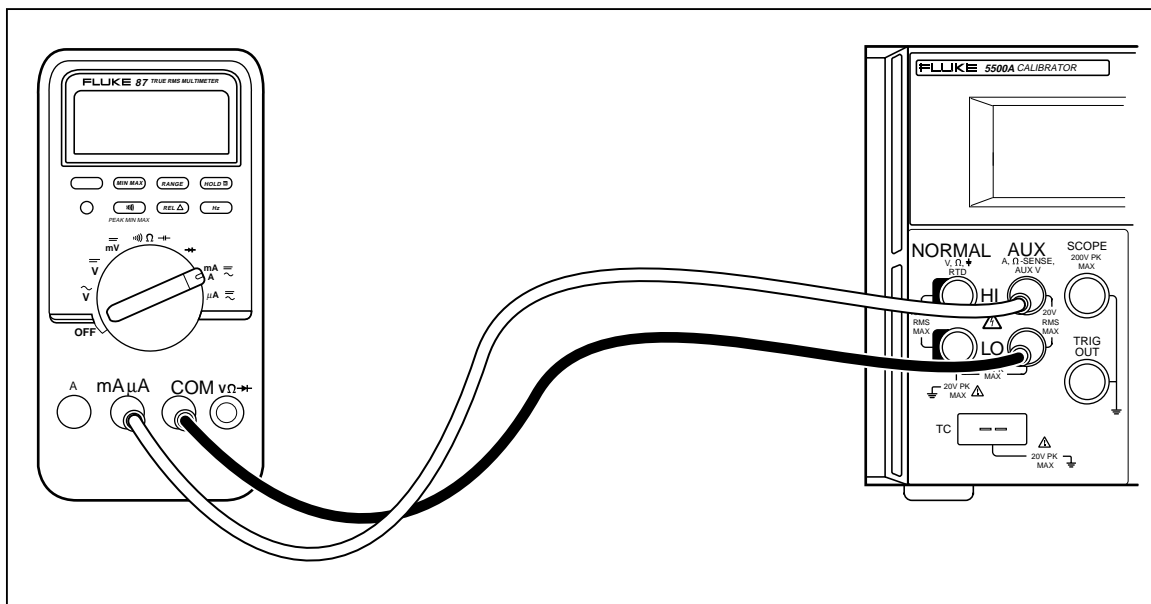

Figure 4-16. Cable Connections for Testing an 80 Series Current Function

f4-16.eps

- c. Set the calibrator to 35.0 mA and press **OPR**.
- d. Use the output adjustment controls to adjust the calibrator output for a reading of +35.00 mA on the DMM. Verify that the error shown on the control display is within specification.
- e. Repeat using 350.0 mA. Verify the error is within specification.
- f. Press the blue button on the DMM to switch to ac current measurement.
- g. Set the calibrator output to 35.0 mA at 60 Hz. Verify the error is within specification.
- h. Repeat the previous step with the following calibrator settings:

AC Current	Frequency
35.0 mA	1.0 kHz
350.0 mA	60 Hz
350.0 mA	1.0 kHz

- i. Press **STBY** on the calibrator and switch the DMM function switch to  $\mu\text{A}$   $\overline{\sim}$ .
- j. Set the calibrator output to 350  $\mu\text{A}$  at 0 Hz. and press **OPR**. Verify the error is within specification.
- k. Repeat the previous step using 3500  $\mu\text{A}$  at 0 Hz.
- l. Press **STBY** on the calibrator and press the blue button on the DMM to switch to ac measurements.
- m. Set the calibrator output to 350.0  $\mu\text{A}$  at 60 Hz and press **OPR**. Verify the error is within specification.
- n. Repeat the previous step with the following calibrator settings:

AC Current	Frequency
350.0 $\mu\text{A}$	1.0 kHz
3500.0 $\mu\text{A}$	60 Hz
3500.0 $\mu\text{A}$	1.0 kHz

12. Test the High current function.
  - a. Press **RESET** on the calibrator.
  - b. Verify that the calibrator is in standby and connect the DMM as shown in Figure 4-17.

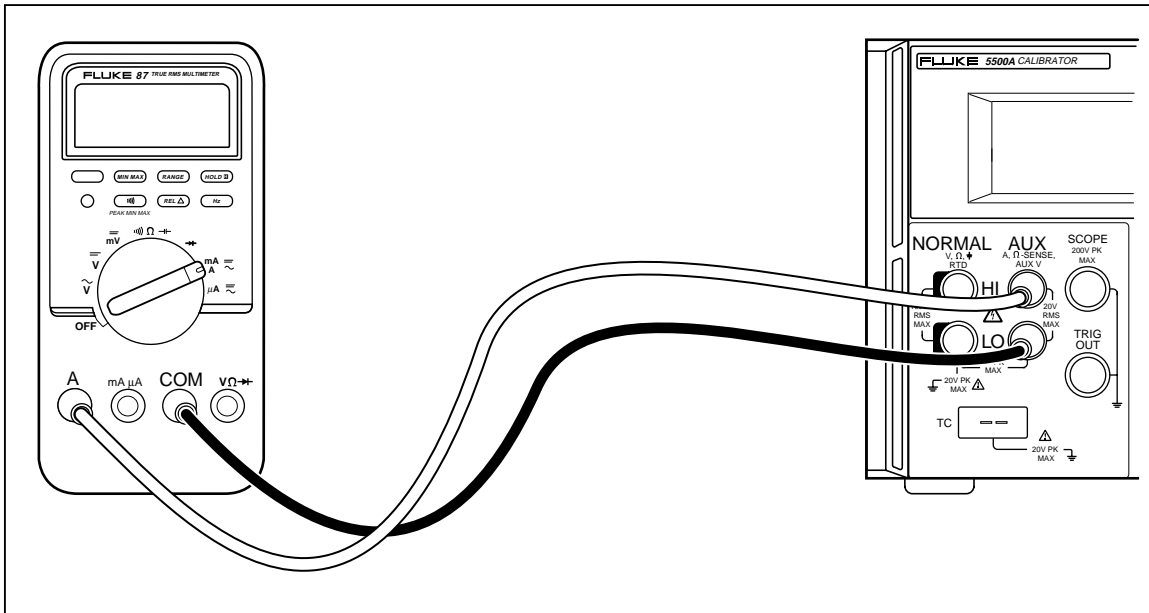

Figure 4-17. Cable Connections for Testing an 80 Series High Amps Function

f4-17.eps

- c. Set the calibrator output to 3.5 A at 0 Hz and press **OPR**. Verify the error is within specification.
- d. Repeat the previous step using 10.0 A at 0 Hz. Verify the error is within specification.
- e. Press **STBY** on the calibrator and press the blue button on the DMM to switch to ac measurements.
- f. Set the calibrator output to 3.5 A at 60 Hz and press **OPR**. Verify the error is within specification.
- g. Repeat the previous step using the following calibrator settings:

AC Current	Frequency
3.5 A	1.0 kHz
10.0 A	60 Hz
10.0 A	1.0 kHz

#### 4-57. Calibrating the Meter

Continue with calibration if any range was out of tolerance in the previous procedure.

##### Note

The adjustment for calibrating the meter requires disassembling the meter. Refer to the diagrams and access procedures in the 80 Series Service Manual.

1. Verify that the calibrator is set to 0 V dc in standby. Press **RESET** if it is not.
2. Turn on the 80 Series DMM, and set its function switch to  $\overline{\text{V}}$ .
3. Connect a set of test leads to the DMM as shown in Figure 4-15.
4. Set the calibrator to 3.5 V dc and press **OPR**.
5. The DMM should now display  $3.500 \pm 0.001$ . If necessary, adjust R21 to obtain the proper display.
6. Set the DMM function switch to  $\tilde{\text{V}}$  and set the calibrator output to 3.500 V at 100 Hz.
7. The DMM should display  $3.500 \pm 0.002$ . If necessary, adjust R34 to obtain the proper display.
8. Change the calibrator output to 10 kHz.
9. The DMM should display  $3.500 \pm 0.004$ . If necessary, adjust C2 to obtain the proper display.
10. Change the calibrator output to 35.00 V at 10 kHz.
11. The DMM should display  $35.00 \pm 0.04$ . If necessary, adjust C3 to obtain the proper display.

#### 4-58. Testing a Model 41 Power Harmonics Analyzer

The Model 41 Power Harmonics Analyzer, hereafter referred to as the Tester, requires two voltages at varying phase relationships to test the functionality of the Power and Harmonics features. The procedure for testing these two functions of the Tester are included here to demonstrate the operation of the dual voltage function of the Fluke 5500A.

##### *Note*

*These procedures are included here as an example. The Model 41 Service Manual contains the complete authoritative testing and calibration procedures.*

#### 4-59. Testing Watts, VA, VAR Performance

Perform the following procedure to test the Watts, VA, and VAR functions of the Tester. Refer to Table 4-4.

### **Warning**

**Ensure that the calibrator is in standby mode before making any connection between the calibrator and Tester. Dangerous voltages may be present on the leads and connectors.**

Table 4-4. Watts Performance, Text Screen

Calibrator Outputs			Performance Limits							
Normal V ac @ 60 Hz	Phase in DEG.	AUX mV ac @ 60 Hz	W/KW		VA/KVA		VAR/KVAR Model 41 Only		Phase Harmonics Screen	
			MIN	MAX	MIN	MAX	MIN	MAX	MIN	MAX
5.0 V	0.0	30.0 mV	145	156	145	156	0	4	-2	2
8.0 V	0.0	30.0 mV	234	246	234	246	0	4	-2	2
100.0 V	157.0	150.0 mV	-14.3k	-13.3k	14. 5k	15. 6k	5.4k	6.3 k	155	159
100.0 V	157.0	360.0 mV	-37k	-29k	32k	40k	10k	18k	155	159
10.0 V	46.0	1.40 V	9.2	10.2	13. 5	14. 5	9.6	10. 6	44	48
100.0 V	46.0	1.40 V	92	102	135	145	96	106	44	48

1. Connect the calibrator to the Model 41 as shown in Figure 4-18.

*Note*

*Voltage is connected to the Model 41 amps channel to simulate current clamp operation (1 mV = 1 A).*

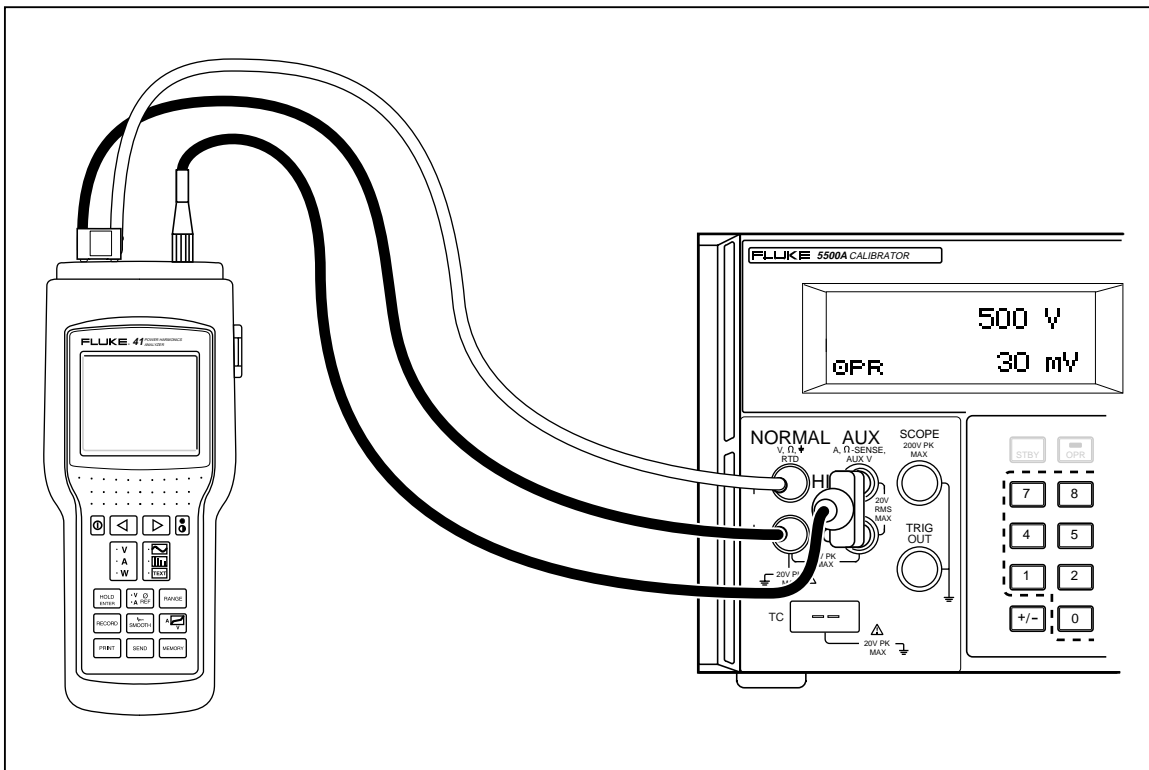







Figure 4-18. Cable Connections for Testing a 40 Series Watts Function

f4-18.eps

2. Verify that the EARTH indicator is on; if not, press **EARTH** as necessary.
3. Set the calibrator output to 5.0V at 60 Hz on the NORMAL output and 30 mV at 60 Hz on the AUX output.

4. Press the WAVE MENUS softkey on the calibrator. Ensure the Phase angle is 0.00 degrees. Press **OPR**.
5. Select W from VAW on the Tester.
6. Press  until the Tester is in the Text Screen mode. Verify that the W/KW, VA/KVA, and VAR/KVAR readings are within the minimum and maximum limits specified in Table 4-4.
7. Press  until the Tester is in the Harmonics screen mode. Verify that the fundamental frequency phase angle readings are between the minimum and maximum readings listed in Table 4-4.
8. Repeat the previous three steps using the calibrator outputs and performance limits listed in Table 4-4.
9. Press **STBY** to remove the voltage from the Tester.

**4-60. Testing Harmonics Volts Performance**

1. Press  until the harmonics screen is displayed on the Tester.
2. Press  until  $\Psi$  is displayed above the upper right corner of the harmonics display.
3. Press  until  $\Psi$  is displayed in the top status line of the Tester.
4. Press  until  $\Psi$ -20s is displayed in the top status line of the Tester.
5. Connect the calibrator NORMAL output to the V and COM connectors on the Tester.
6. Connect the calibrator AUX output to the Current Probe connector on the Tester.
7. Set the calibrator output to 7.0V at 60 Hz on the NORMAL output and 700 mV at 60-Hz on the AUX output. Press the WAVE MENUS softkey and ensure the phase angle is -10.0 degrees. Press the HARMONIC MENU softkey and ensure the HARMONIC selection is set to “1” and the FUNDMTL selection is set to “aux.” Press **OPR**.
8. Move the Tester cursor to the corresponding harmonic number.
9. Verify that the harmonic amplitude and phase angle readings displayed by the Tester are within the minimum and maximum limits listed in Table 4-5. (Note: The Tester will read a positive phase when the 5500A output is a negative phase because, on the 5500A, the polarity of the phase is always relative to the NORMAL channel output.)
10. Repeat the previous three steps using the settings and limits in Table 4-5.





**Table 4-5. Harmonics Performance for Volts, Harmonics Screen**

5500A Normal Output			Fluke Tester	Performance Limits			
Amplitude (V)	Harmonic No.	Phase (deg.)	Harmonic cursor No.	Amplitude		Phase	
				MIN	MAX	MIN	MAX
7.00	1	-10	1	6.7	7.3	8	12
7.00	3	-20	3	6.7	7.3	14	26
7.00	9	-30	9	6.7	7.3	21	39
7.00	13	-40	13	6.7	7.3	29	51
7.00	21	-50	21	6.5	7.5	35	65
7.00	31	-60	31	6.2	7.8	40	80

11. Press **STBY** to remove the voltage from the Tester.



**4-61. Testing Harmonics Amps Performance**

1. Press  until  $\hat{A}$  is displayed above the upper right corner of the harmonics display.
2. Press  until  $V_{REF}$  is displayed in the top status line of the Tester.
3. Press  until  $\sqrt{v}-20s$  is displayed in the top status line of the Tester.
4. Connect the calibrator NORMAL output to the V and COM connectors on the Tester.
5. Connect the calibrator AUX output to the Current Probe connector on the Tester.
6. Set the calibrator output to 7.0 V at 60 Hz on the NORMAL output and 20 mV at 60 Hz on the AUX output. Press the WAVE MENU softkey and ensure the phase angle is 10.00 degrees. Press the HARMONIC MENU softkey and ensure the HARMONIC selection is set to “1” and the FUNDMTL selection is set to “normal.” Press .
7. Verify that the harmonic amplitude and phase angle readings displayed by the Tester are within the minimum and maximum limits listed in Table 4-6.

**Table 4-6. Harmonics Performance for Amps, Harmonics screen**

5500A AUX Output			Fluke Tester	Performance Limits			
Amplitude (mV)	Harmonic No.	Phase (deg.)	Harmonic cursor No.	Amplitude		Phase	
				MIN	MAX	MIN	MAX
20.0	1	10	1	19.1	20.9	8	12
20.0	3	20	3	19.1	20.9	14	26
20.0	9	30	9	19.1	20.9	21	39
20.0	13	40	13	19.1	20.9	29	51
20.0	21	50	21	18.7	21.3	35	65
20.0	31	60	31	18.1	21.9	40	80

**4-62. Calibrating a Fluke 51 Thermometer**

The Fluke 51 Thermometer measures temperature using a type J or K thermocouple. The calibrator simulates both thermocouples, simplifying testing and calibration. The following demonstrates how the calibrator is used to calibrate this thermometer.

*Note*

*These procedures are included here as an example. The Model 51 Service Manual contains the authoritative testing and calibration procedures.*

#### 4-63. Testing the Thermometer

The following test should be conducted only after the thermometer has had time to stabilize to an ambient temperature of  $23^{\circ}\text{C} \pm 5^{\circ}\text{C}$  ( $73^{\circ}\text{F} \pm 9^{\circ}\text{F}$ ).

1. Connect the Fluke 51 Thermometer to the calibrator using the appropriate connection cable (Figure 4-19). The connection cable and miniconnector material must match the thermocouple type. For example, if testing a K thermocouple, the cable and miniconnector are for a K thermocouple.

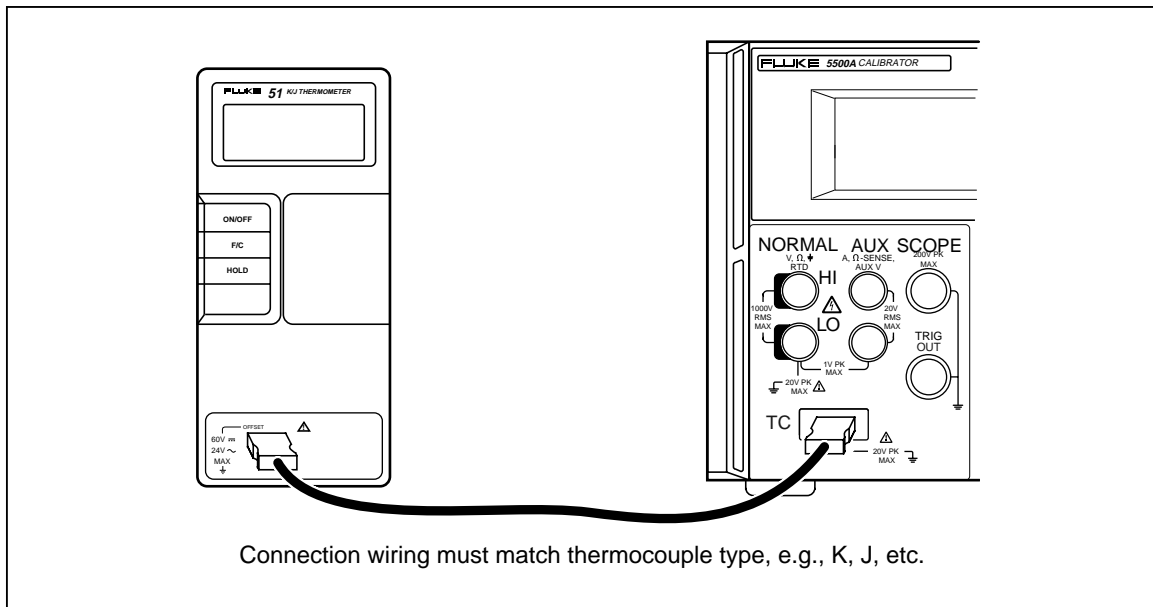

f4-19.eps

Figure 4-19. Cable Connections for Testing a 50 Series Thermometer

2. Verify that the EARTH indicator is on; if not, press **EARTH** as necessary.
3. Set up the calibrator by pressing **0** **°C** **ENTER**. Ensure the softkey labeled OUTPUT indicates **tc**. If not, press the OUTPUT softkey until it does.
4. Select the thermocouple type and reference source by pressing the TC MENUS softkey. Ensure the REF SRC softkey selection indicates “intrnl.” If not, press the REF SRC softkey. Ensure the TYPE softkey indicates either J or K, depending on which one the 51 is set to. Continue to press the TYPE softkey until the selected thermocouple type is displayed.
5. Enter the calibrator settings listed in Table 4-7 and verify performance is within specifications (see Section 1).

Table 4-7. Thermocouple Performance

Thermocouple Type [1]	5500A Setting	Display Readings	
		Degrees C	Degrees F
K	-182.0°C	-182.0 ± (0.9)	-295.6 ± (1.6)
K	-80.0°C	-80.0 ± (0.8)	-112.0 ± (1.4)
K	530.0°C	530.0 ± (1.2)	986.0 ± (2.3)
K	1355.0°C	1355.0 ± (2.1)	2471.0 ± (3.8)
J	-197.0°C	-197.0 ± (1.0)	-322.6 ± (1.7)
J	258.0°C	258.0 ± (1.1)	496.4 ± (1.9)
J	705.0°C	705.0 ± (1.5)	1301.0 ± (2.7)

[1] When changing thermocouple types, be use to change the corresponding hookup wire, e.g., K-type thermocouple wire changes to J-type thermocouple wire.

#### 4-64. Calibrating the Thermometer

The following procedure refers to the Fluke 51 as the Unit Under Test (UUT). Use copper hookup wire for all connections, except for steps 17 to 20.

### Caution

**When you are directed to short a switch grid on the 51, use only the elastomeric switch pad that is supplied, because you could damage the printed circuit assembly (pca) if a hard tool is used.**

1. Turn the UUT off and remove the top case, leaving the pca in the bottom case.
2. Ensure the calibrator is in standby and connect the UUT to the calibrator as shown in Figure 4-19. When making this connection with the UUT case top removed, make sure that the wide blade is oriented the same as the case top would normally allow.
3. Simultaneously short the TP1 grid and turn on the UUT by shorting the ON/OFF switch grid. Hold the elastomeric switch pad on TP1 for at least 3 seconds after turn on. This puts the UUT into the Thermocouple Calibration mode.
4. Select °C mode and T1 on the UUT.

#### Note

*The next few steps require specific voltages to be present on the inputs of the Thermometer. By using the 10µV/°C type thermocouple selection of the calibrator, you can specify the output voltage on the TC jacks.*

5. Press **0**, **°C** and **ENTER**. Ensure the softkey labeled OUTPUT indicates “tc”. If not, press the OUTPUT softkey until it does.
6. Press the TYPE softkey until 10 µV/°C is displayed. This selection allows you to specify the voltage on the TC jack.
7. Press the TC MENU softkey.

8. Press REF SRC softkey until “external” is displayed.
9. Press the REF softkey to enter an external reference value.
10. Press **0** and **ENTER** to set the external reference to 0°C.
11. Press PREV MENU to go back one menu level.
12. Press **OPR**.
13. Allow the UUT reading to settle and then adjust the T1 offset adjustment (R7) for a display reading of 25.2°C ± 0.1°C.
14. Change the calibrator output to 5380.7°C. This places 53.807 mV on the tc jacks.
15. Allow the UUT reading to settle and adjust R21 for a display reading of +1370.0°C ± 0.4°C.
16. Press **STBY** on the calibrator to remove voltage from the UUT. Disconnect the UUT from the 5500A. Power down the UUT by shorting the ON/OFF switch grid.
17. With an elastomeric switch pad in both hands, use the left one to short out the TP2 grid, and use the right one to first turn on the instrument and then quickly short out the VIEW switch grid. Hold this position until the display is held in self-test. This puts the UUT into the Reference Junction Sensor calibration mode, and the VIEW maneuver turns off a filter so that the reading settled immediately.
18. Using a K thermocouple bead (supplied with the 5500A/LEADS test lead kit) and the 5500A Calibrator MEAS TC mode (press **MEAS TC**), measure the reference junction transistor temperature by placing the K-bead into the middle hole of the isothermal block. The bead tip should be placed into the well, against the body of Q1. Hint: Covering the well and positioning the bead with a piece of tissue may help the bead stay in place. Do not hold the bead in place with your hands as this may introduce a measurement error. Wait for the temperature reading to stabilize.
19. Adjust R16 for a temperature reading on the UUT that is the same as displayed on the 5500A Calibrator.
20. Power down the UUT and reassemble.

# Chapter 5

## Remote Operation

	<b>Contents</b>	<b>Page</b>
5-1.	Introduction.....	5-4
5-2.	Setting up the IEEE-488 Port for Remote Control .....	5-4
5-3.	IEEE-488 Port Setup Procedure .....	5-7
5-4.	Testing the IEEE-488 Port.....	5-8
5-5.	Setting up the RS-232 Host Port for Remote Control .....	5-10
5-6.	RS-232 Host Port Setup Procedure .....	5-10
5-7.	Testing the RS-232 Host Port.....	5-12
5-8.	Testing RS-232 Host Port Operation using a Terminal .....	5-12
5-9.	Testing RS-232 Host Port Operation using Visual Basic .....	5-14
5-10.	Setting up the RS-232 UUT Port for Remote Control.....	5-15
5-11.	RS-232 UUT Port Setup Procedure.....	5-15
5-12.	Testing the RS-232 UUT Port via RS-232 Host Port.....	5-17
5-13.	Testing RS-232 UUT Port Operation via a Terminal .....	5-17
5-14.	Testing RS-232 UUT Port Operation using Visual Basic .....	5-18
5-15.	Testing the RS-232 UUT Port via IEEE-488 Port.....	5-19
5-16.	Changing between Remote and Local Operation .....	5-21
5-17.	Local State.....	5-21
5-18.	Local with Lockout State .....	5-21
5-19.	Remote State.....	5-21
5-20.	Remote with Lockout State .....	5-21
5-21.	RS-232 Interface Overview .....	5-22
5-22.	IEEE-488 Interface Overview.....	5-23
5-23.	Using Commands.....	5-25
5-24.	Types of Commands.....	5-25
5-25.	Device-Dependent Commands.....	5-25
5-26.	Common Commands .....	5-26
5-27.	Query Commands.....	5-26
5-28.	Interface Messages (IEEE-488) .....	5-26
5-29.	Compound Commands .....	5-28
5-30.	Coupled Commands .....	5-28
5-31.	Overlapped Commands .....	5-29
5-32.	Sequential Commands.....	5-29
5-33.	Commands that Require the Calibration Switch to be Enabled...	5-29
5-34.	Commands for RS-232 Only.....	5-29
5-35.	Commands for IEEE-488 Only .....	5-30

5-36.	Command Syntax .....	5-31
5-37.	Parameter Syntax Rules .....	5-31
5-38.	Extra Space or Tab Characters.....	5-32
5-39.	Terminators .....	5-33
5-40.	Incoming Character Processing.....	5-33
5-41.	Response Message Syntax .....	5-34
5-42.	Checking 5500A Status .....	5-35
5-43.	Serial Poll Status Byte (STB).....	5-35
5-44.	Service Request (SRQ) Line .....	5-37
5-45.	Service Request Enable Register (SRE) .....	5-37
5-46.	Programming the STB and SRE.....	5-38
5-47.	Event Status Register (ESR).....	5-38
5-48.	Event Status Enable (ESE) Register .....	5-38
5-49.	Bit Assignments for the ESR and ESE .....	5-38
5-50.	Programming the ESR and ESE.....	5-39
5-51.	Instrument Status Register (ISR).....	5-40
5-52.	Instrument Status Change Registers.....	5-40
5-53.	Instrument Status Change Enable Registers .....	5-40
5-54.	Bit Assignments for the ISR, ISCR, and ISCE .....	5-40
5-55.	Programming the ISR, ISCR, and ISCE.....	5-42
5-56.	Output Queue .....	5-42
5-57.	Error Queue .....	5-43
5-58.	Remote Program Examples.....	5-43
5-59.	Guidelines for Programming the Calibrator .....	5-43
5-60.	Writing an SRQ and Error Handler.....	5-44
5-61.	Verifying a Meter on the IEEE-488 Bus .....	5-45
5-62.	Verifying a Meter on the RS-232 UUT Serial Port.....	5-45
5-63.	Using *OPC?, *OPC, and *WAI.....	5-45
5-64.	Taking a Thermocouple Measurement.....	5-46
5-65.	Using the RS-232 UUT Port to Control an instrument .....	5-46
5-66.	Input Buffer Operation .....	5-47

**⚠ ⚠ Warning**

The 5500A Calibrator can produce voltages up to 1000 V rms and must be programmed with caution to prevent hazardous voltages from being produced without sufficient warning to the operator.

Programs should be written carefully and tested extensively to ensure safe operation of the 5500A Calibrator. Fluke suggests that you include error catching routines in your programs. These error catching routines will assist in detecting programming errors that could result in the instrument behaving differently to your intention. By setting the Service Request Enable (SRQ) register, described in paragraph 5-60, the 5500A Calibrator can be programmed to cause an SRQ when an error is detected. The following program example shows a skeleton program including error catching:

```
10 PRINT @4, "*CLS"           ! Clear status
20 PRINT @4, "*SRE 8"         ! Set SRE Error Available
30 ON SRQ GOTO 1000          ! Enable SRQ Function
100                           ! Place body of program here

900 STOP                     ! End of program

1000 REM Start of SRQ Handler  ! Start routine
1010 PRINT @4, "FAULT?"      ! Request fault code
1020 INPUT @4, A%            ! Input fault code
1030 PRINT @4, "EXPLAIN? ";A% ! Request fault text
1040 INPUT @4, A$            ! Input fault text
1050 PRINT "Fault ";A$" detected" ! Print message
1060 PRINT @4, "STBY"        ! Place 5500A in standby
1070 STOP
```

## 5-1. Introduction

This chapter describes methods for operating the 5500A Calibrator by remote control. Remote control can be interactive, with the user controlling each step from a terminal, or under the control of a computer program running the calibrator in an automated system. The 5500A Calibrator rear panel has three ports for remote operations: IEEE-488 parallel port (also known as a General Purpose Interface Bus, or GPIB port), and two RS-232 serial ports, SERIAL 1 FROM HOST and SERIAL 2 TO UUT.

**IEEE-488** The IEEE-488 parallel port is usually used in larger control and calibration systems. An IEEE-488 system is more costly to set up, but has the ability to serve multiple 5500A Calibrators and multiple UUTs. Also, parallel system throughput is faster than serial system throughput. The controller in an IEEE-488 system is typically a MS-DOS compatible personal computer (PC) equipped with one or more IEEE-488 ports. You can write your own computer programs for system operation using the command set, or you can purchase optional Fluke calibration software MET/CAL or 5500A/CAL, and property management software MET/TRACK. Typical IEEE-488 configurations are shown in Figure 5-1. The configuration showing the PC with two IEEE-488 ports is used with MET/CAL, which prefers UUTs on a separate IEEE-488 port. You can also “piggy-back” the connectors on a single IEEE-488 port.

**RS-232** The SERIAL 1 FROM HOST serial port connects the PC and 5500A Calibrator, while the SERIAL 2 TO UUT serial port acts as a pass-through port, passing commands from the PC to UUT via the 5500A Calibrator. You can write your own computer programs using the command set, or operate the PC as a terminal and enter individual commands, or you can purchase optional Fluke MET/CAL or 5500/CAL software for RS-232 system operations. Typical RS-232 remote configurations are shown in Figure 5-2.

After configuring the IEEE-488 or RS-232 port for remote operation, you are ready to begin using the command set. The operation of the command set is described under “Using Commands” in this chapter. A summary of remote commands are listed in Chapter 6, “Remote Commands.”

## 5-2. Setting up the IEEE-488 Port for Remote Control

The 5500A Calibrator is fully programmable for use on the IEEE Standard 488.1 interface bus. The IEEE-488 interface is also designed in compliance with supplemental standard IEEE-488.2, which describes additional IEEE-488 features. Devices connected to the IEEE-488 bus are designated as talkers, listeners, talker/listeners, or controllers. Under remote control of an instrument, the 5500A Calibrator operates as a talker/listener.

A PC equipped with an IEEE-488 interface, controls the the 5500A Calibrator. Compatible software for IEEE-488 operation may be purchased from Fluke, including METCAL and METRACK. Another software package, 5500/CAL, is also available but operates only on the RS-232 serial interface.

When using the IEEE-488 remote control interface, there are two restrictions:

1. **Number of Devices** A maximum of 15 devices can be connected in a single IEEE-488 bus system. For example, one instrument controller, one 5500A Calibrator, and thirteen units under test (UUTs).
2. **Cable Length** The total length of IEEE-488 cables used in one IEEE-488 system is 2 meters times the number of devices in the system, or 20 meters, whichever is less. For example, if 8 devices are connected, the maximum cable length is  $2 \times 8 = 16$  meters. If 15 devices are connected, the maximum cable length is 20 meters.



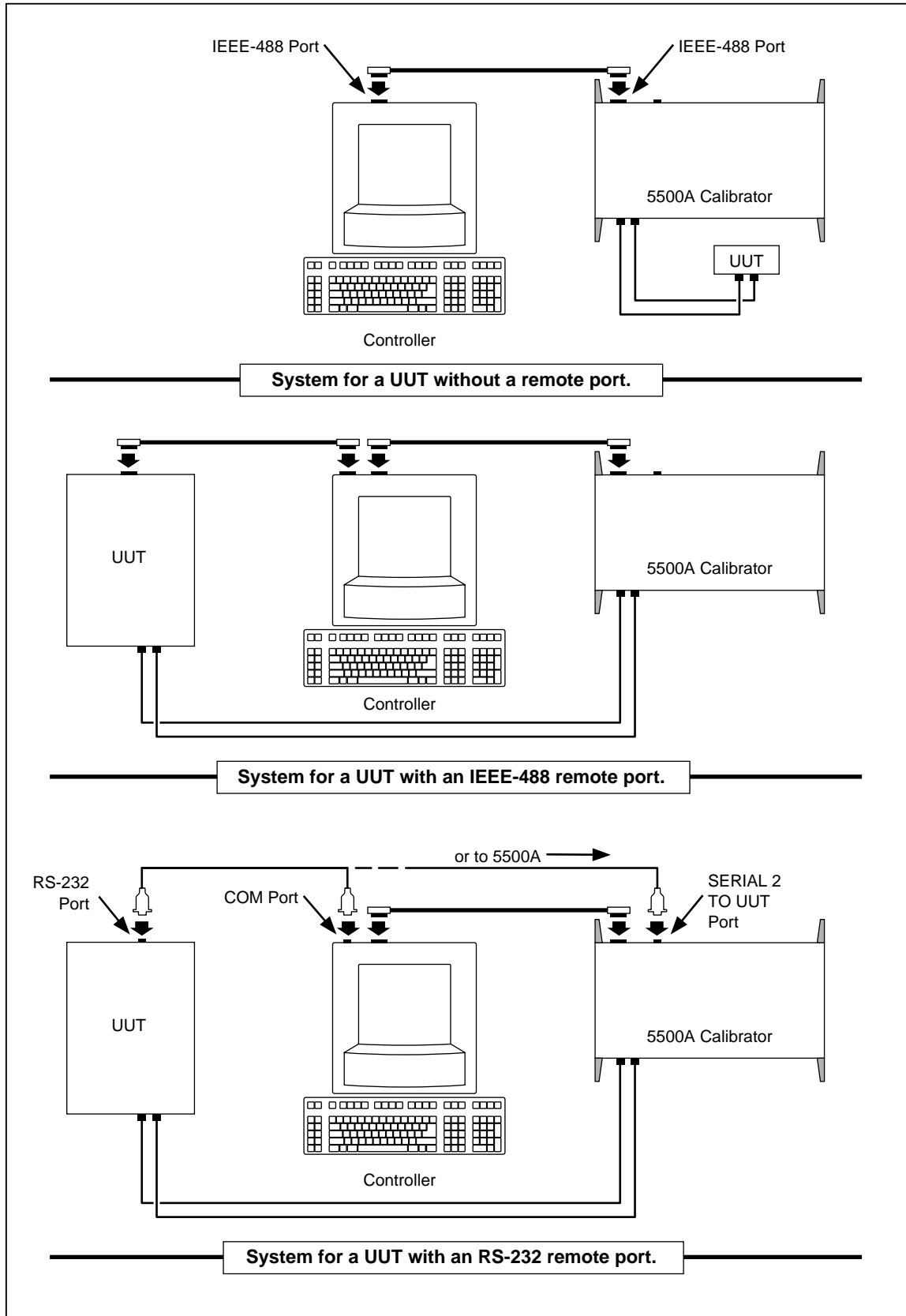

Figure 5-1. Typical IEEE-488 Remote Control Connections

F5-01.eps

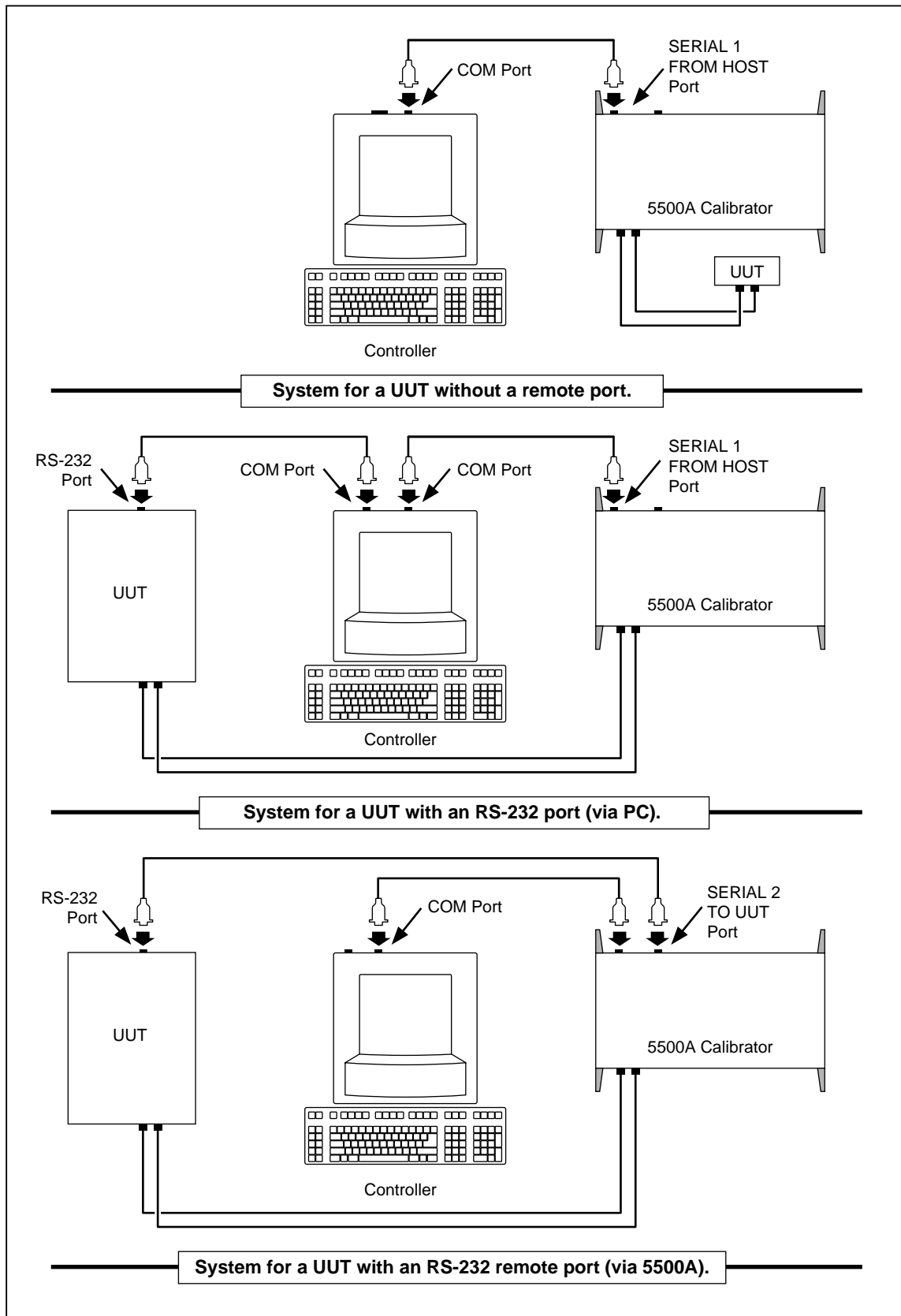

Figure 5-2. Typical RS-232 Remote Control Connections

F5-02.eps

**5-3. IEEE-488 Port Setup Procedure**

Complete the following procedure to set up the 5500A Calibrator for remote operations using the IEEE-488 remote control port. The purpose is to select GPIB as the interface and to select the GPIB address for the interface.

1. Turn the 5500A Calibrator power on. You may operate the calibrator during warmup, but specifications are not guaranteed until warmup is complete.
2. Press the **SETUP** key on the 5500A Calibrator front panel.
3. Negotiate the softkey selections shown below. Verify the HOST port selection is gpib. Select the desired GPIB port address (0 to 30) using the UP/DOWN softkeys. The factory default is 4.

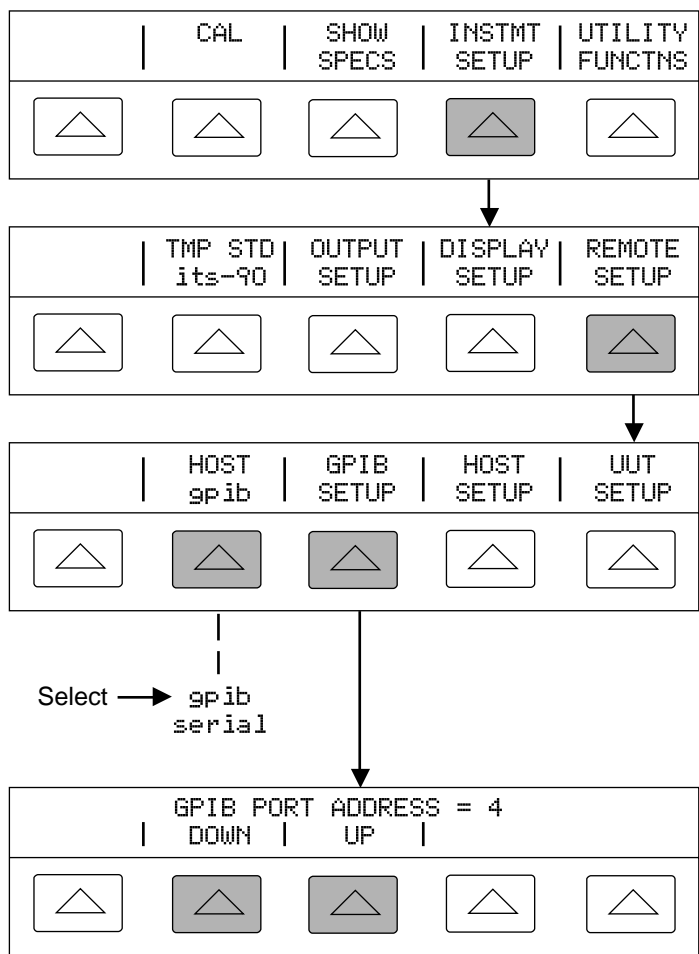

gl40f.eps

4. Press **PREV MENU** (not **ENTER**) several times until the message STORE CHANGES/DISCARD CHANGES appears or, if there were no changes, the reset display. If you select STORE CHANGES, the gpib and host port setting are saved in the instrument non-volatile memory.

#### 5-4. Testing the IEEE-488 Port

The procedure below tests IEEE-488 communications between the PC and the Calibrator using the Win32 Interactive Control utility. This utility is supplied with National Instruments interface cards for the PC, which are the recommended interfaces. (See Chapter 9, "Accessories.") Figure 5-3 shows a typical connection.

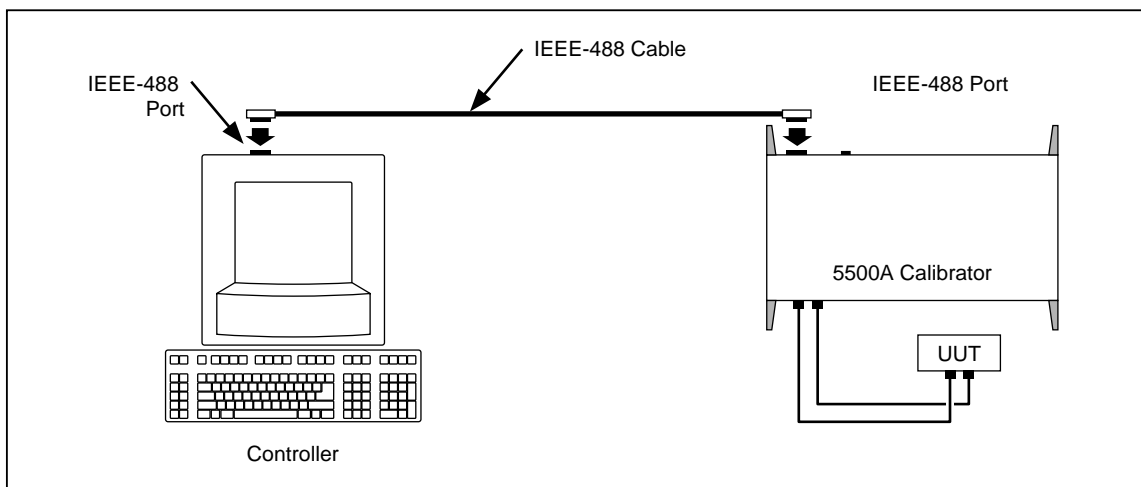
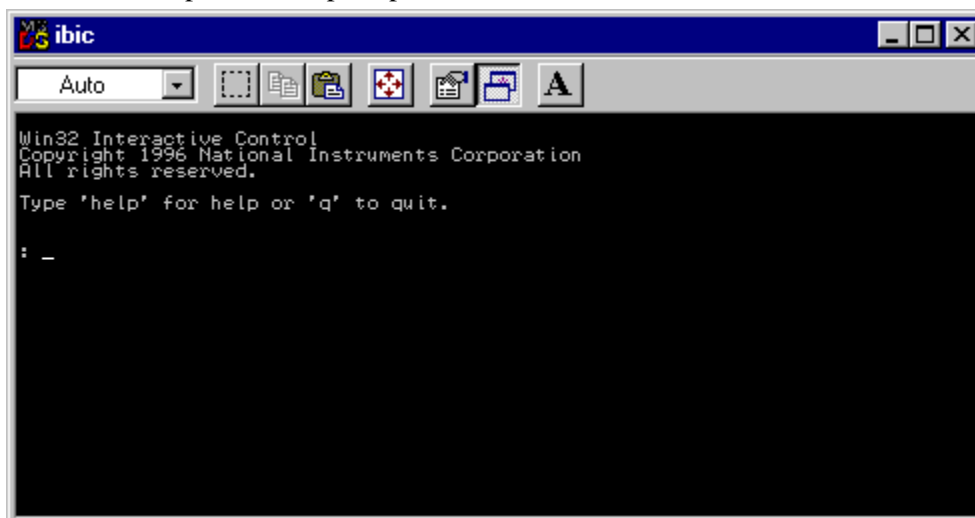

Figure 5-3. Typical IEEE-488 Port Connections

f5-0a.eps

Complete the following procedure to test IEEE-488 operation using Win32 Interactive Control:

1. Complete the "IEEE-488 Port Setup Procedure" earlier in this chapter to set up the 5500A for GPIB operation. Note the GPIB Address Port (default is 4).
2. Connect the PC and 5500A IEEE-488 ports using a standard IEEE-488 cable. (See Chapter 9, "Accessories," for IEEE-488 cables available from Fluke.)
3. From the programs menu, select "NI-488.2M software for...(your operating system)".
4. From the NI488.2M software menu, select "Win32 interactive control". A DOS window opens with a prompt as shown below.



- At the prompt, type the following line to activate the IEEE interface card:

```
<ibdev 0 4 0 10 1 0>
```

The second number in this line is the primary address of the calibrator. If the address has been changed from the factory default, change this line accordingly.

- The prompt reads <ud0:>. From this prompt type <ibwrt "remote"> then press the ENTER (or RETURN) key.
- Verify that the calibrator is now in remote control.
- Select the Local command from the Control menu, then click OK in the Parameter Input Window. Observe the Calibrator Control Display changes back to the reset condition shown below.

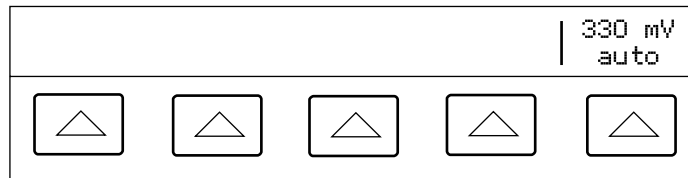

nn323f.eps

- From the ud0: prompt, type <q> and then press the ENTER (or RETURN) key.

## 5-5. Setting up the RS-232 Host Port for Remote Control

The 5500A Calibrator is fully programmable over an RS-232 link with a PC the rear panel SERIAL 1 FROM HOST port (Figure 5-2). You can enter individual commands from a terminal, write your own programs using, for example, a Windows-based language such as Visual Basic, or run optional Windows-based Fluke software such as 5500/CAL or MET/CAL.

The RS-232 cable length for the port should not exceed 15 meters (50 feet), although longer cable lengths are permitted if the load capacitance measured at a connection point (including signal terminator) does not exceed 2500 pF.

## 5-6. RS-232 Host Port Setup Procedure

Complete the following procedure to set up the SERIAL 1 FROM HOST port. The RS-232 parameters you select here must match the parameters set for the PC COM port. The factory defaults (shown below in **bold**) are 9600 baud, 8 data bits, 1 stop bit, and no parity. Other parameters include flow control, EOL (end-of-line) character, and EOF (end-of-file) characters.

1. Turn the 5500A Calibrator power on. You may operate the calibrator during warmup, but specifications are not guaranteed until warmup is complete.
2. Press the **SETUP** key on the 5500A Calibrator front panel.
3. Negotiate the softkey selections shown below to select the serial port for remote operation, then continue to Step 4.

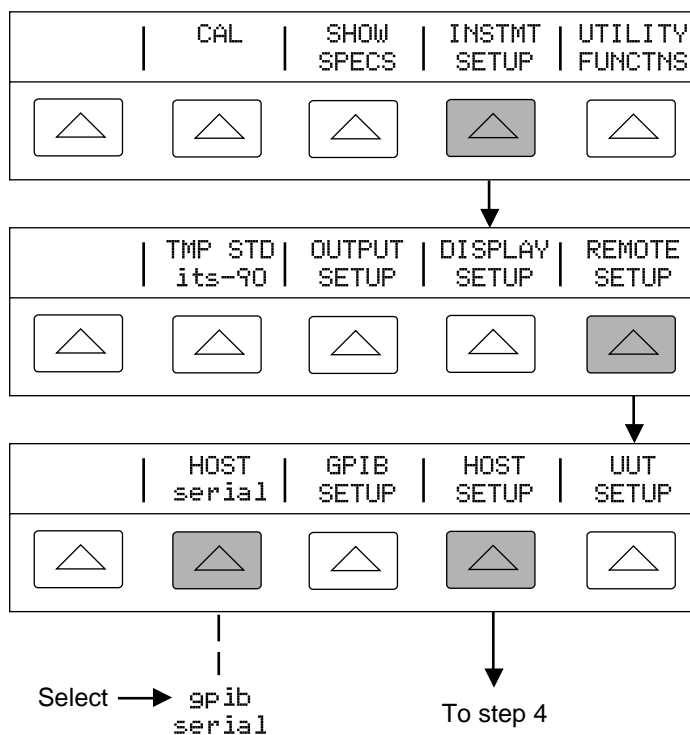

gl43f.eps

4. Negotiate the softkey selections shown below to select the HOST serial port parameters to match the PC COM parameters. (Individual softkey functions are discussed in Chapter 3, “Features.”) If operating the port with a computer program instead of individual commands from a terminal, select Remote I/F **comp**.

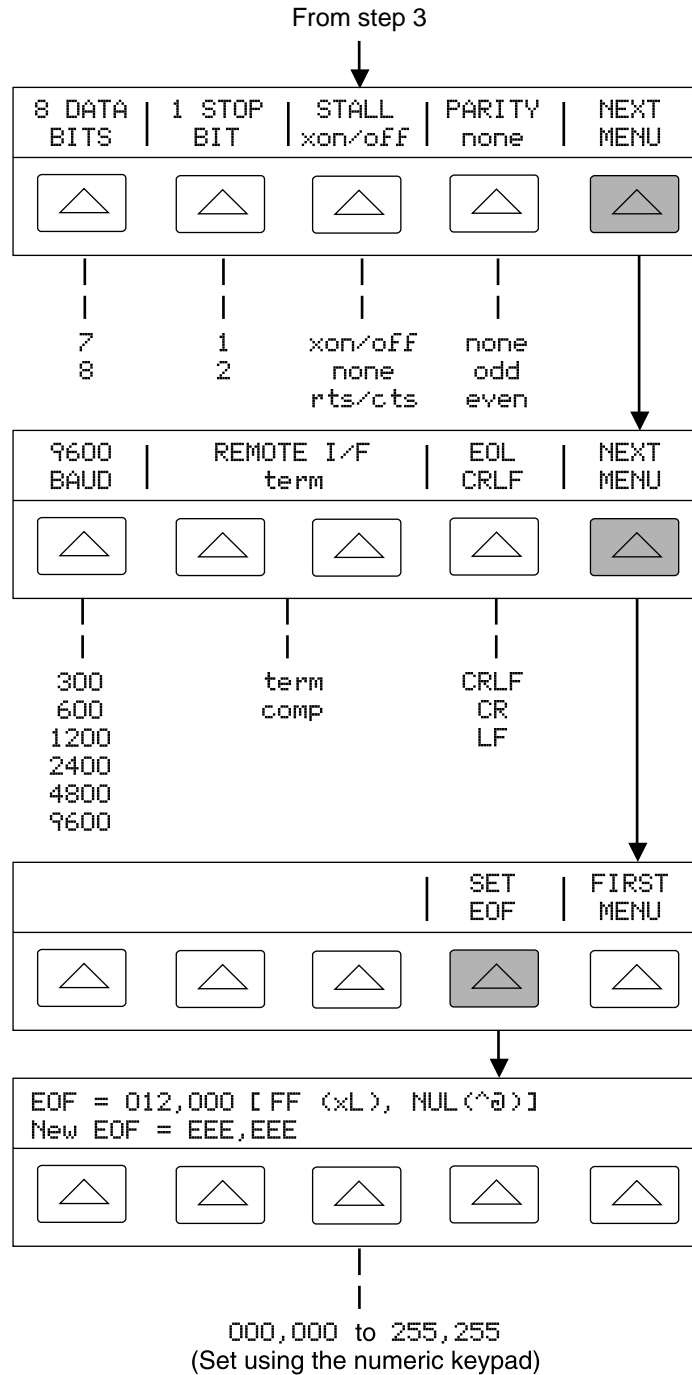

5. Press **PREV MENU** (not **ENTER**) several times until the message **STORE CHANGES/DISCARD CHANGES** appears or, if there were no changes, the reset display. If you select **STORE CHANGES**, the serial and host port setting are saved in the instrument non-volatile memory.

gl44f.eps

### 5-7. Testing the RS-232 Host Port

Choose or adapt one of the following test procedures to test the 5500A Calibrator RS-232 Host port connected to a PC COM port. A typical connection is shown in Figure 5-4. Note the use of a null modem cable for connection. (See Appendix D for information about RS-232 cables and connectors.)

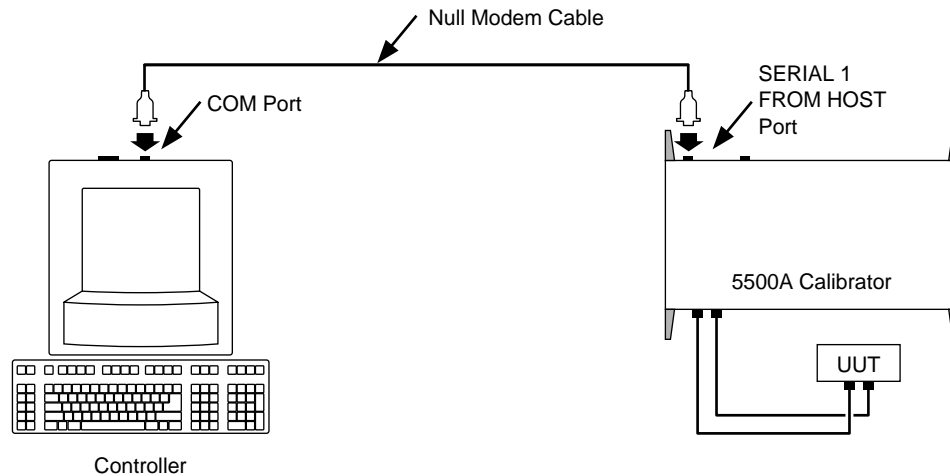

Figure 5-4. Typical PC COM Port Connections

F5-0e.eps

**Terminal** This procedure uses the Terminal accessory supplied with Windows (or equal) to test RS-232 Host port operation. To use this method, you must select term as the Remote I/F in Step 4 in the procedure “RS-232 Host Port Setup Procedure.”

**Visual Basic** This procedure uses Visual Basic (see Appendix E) to test RS-232 Host port and RS-232 UUT port operation.

### 5-8. Testing RS-232 Host Port Operation using a Terminal

Complete the following procedure to test RS-232 Host port operation using the Windows Terminal accessory (or equal).

1. Complete the “RS-232 Host Port Setup Procedure” earlier in this chapter to set up the 5500A for RS-232 Host port operation. Note the RS-232 Host port parameters that you selected in this procedure.
2. Connect the selected COM port on the PC to the 5500A SERIAL 1 FROM HOST port using a standard null-modem RS-232 cable. (See Appendix D for information on RS-232 cables and connectors.)
3. Open Windows to the Program Manager screen on your PC.



4. Open Terminal from the Accessory group of Program Manager (below). If a terminal configuration file already exists, e.g., `host.term`, select the desired file using the Open command from the File menu and go to Step 7. Otherwise, go to Step 5.

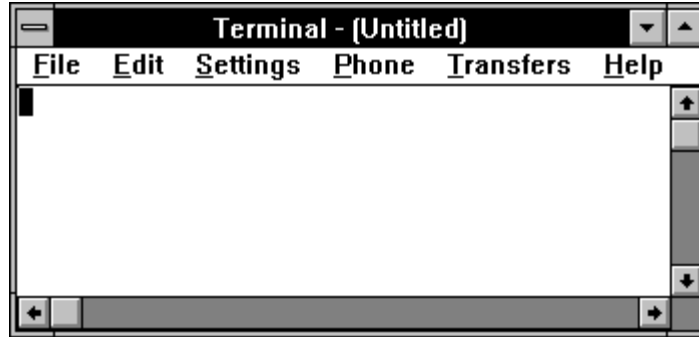

F5-0f.bmp

5. Select the Communications command from the Setting menu. Enter the RS-232 parameters that match those selected at the 5500A Calibrator for the Host port. If using the 5500A factory defaults, the Communications dialog box for COM1 will appear as shown below. Select COM as required. Click OK.

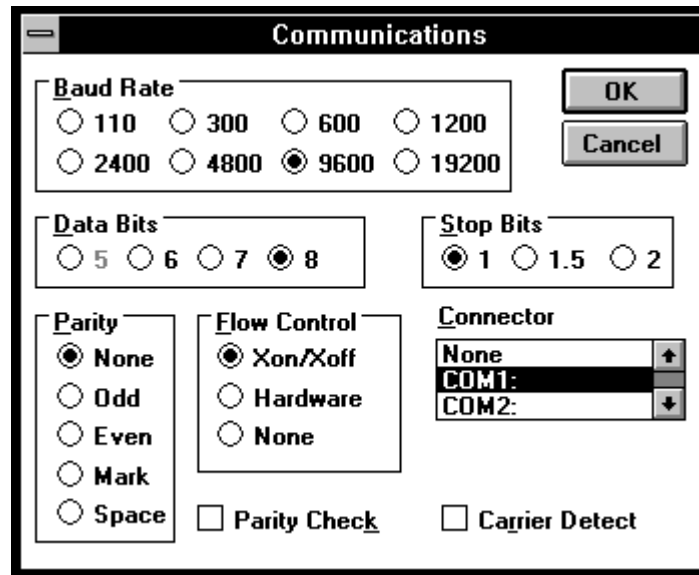

F5-0g.bmp

6. Verify the 5500A Calibrator is powered and in the reset condition. (If in doubt, press the **RESET** key on the 5500A Calibrator front panel.)
7. On the Terminal screen, type the command `REMOTE` and press `<Enter>`. Observe the 5500A Calibrator Control Display changes to `REMOTE CONTROL` (below).

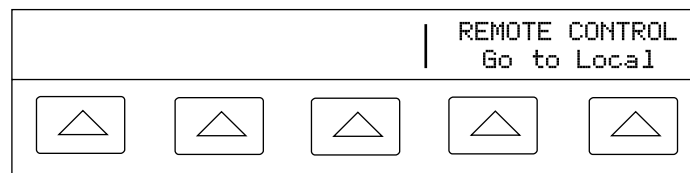

gl41f.eps

The characters REMOTE should have appeared on the terminal screen as they were entered. If they did not appear on the screen, but the Control Display changed to REMOTE CONTROL, then refer to step 4 of the “RS-232 Host Port Setup Procedure” and change the REMOTE I/F setting from comp to term.

If nonsense characters appeared on the screen, then you have a mismatch in RS-232 parameters. Refer to step 4 of the “RS-232 Host Port Setup Procedure” procedure for the correct RS-232 settings and then repeat this procedure starting at Step 5.

If no characters appeared on the screen, then refer to step 3 of the “RS-232 Host Port Setup Procedure” procedure to verify serial was selected for the Host port. Check that you used the correct RS-232 cable. It must be in a null-modem configuration where the RX and TX lines are reversed (see Appendix D) Also verify you have connected to the correct COM port on the PC.

8. Type the command LOCAL and press <Enter>. Observe the 5500A Calibrator Control Display changes back to the reset condition (below).

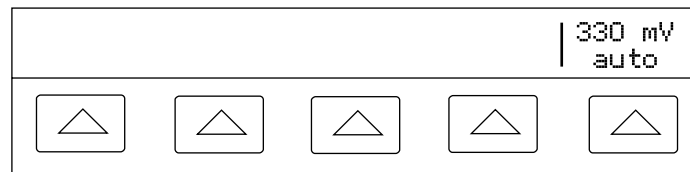

gl42f.eps

If you want to experiment with other commands in the command set, see Chapter 6, “Remote Commands.” When finished, select the Exit command from the File menu to close the Terminal accessory.

Hint: To save the communication parameters in Terminal for future operations, first select Save from the File menu and then assign a name, for example, `host . term`.

### 5-9. Testing RS-232 Host Port Operation using Visual Basic

Complete the following procedure to test RS-232 (Host) operation using the Windows-based programming language Visual Basic. This procedure assumes you have completed Appendix E, “Creating a Visual Basic Test Program” to create the group RS-232 Test.

Complete the following procedure to test RS-232 operation using Visual Basic.

1. Complete the “RS-232 Host Port Setup Procedure” earlier in this chapter to set up the 5500A for RS-232 Host port operation. Note the RS-232 Host port parameters that you selected in this procedure.
2. Connect the selected COM port on the PC to the 5500A SERIAL 1 FROM HOST port using a standard null-modem RS-232 cable. (See Appendix D for information on RS-232 cables and connectors.)
3. To start the program, open the Test Ports icon from the RS-232 Test group (below).

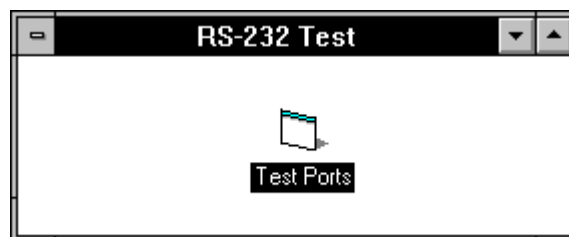

F5-0a.bmp

4. Verify the 5500A Calibrator is powered and in the reset condition (if in doubt, press the **RESET** key), then click the Command1 button (below).

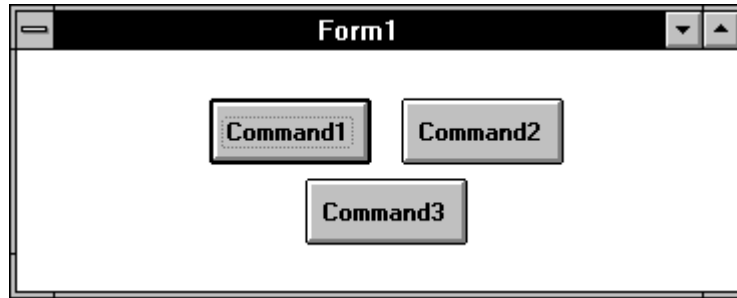

F5-0h.bmp

- Observe the 5500A Calibrator Control Display changes to REMOTE CONTROL (below).

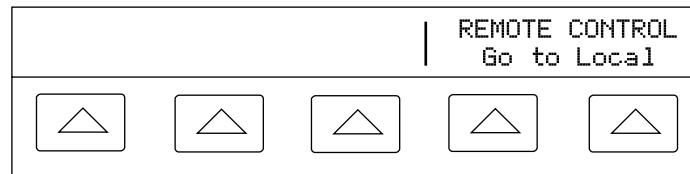

gl41f.eps

- Click the Command2 button. Observe the 5500A Calibrator Control Display changes back to the reset condition (below).  
(The Command3 button is used for RS-232 UUT port testing later in this chapter.)

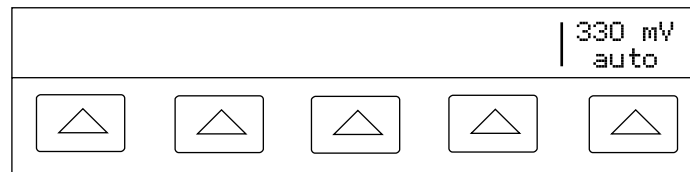

gl42f.eps

- Close the program by clicking the top-left corner and Close.

### **5-10. Setting up the RS-232 UUT Port for Remote Control**

The SERIAL 2 TO UUT serial data port connects a UUT to a PC or terminal via the 5500A Calibrator (Figures 5-1 and 5-2). This “pass-through” configuration eliminates the requirement for two COM ports at the PC or Terminal. The UUT\_\* commands (see Chapter 6) handle the UUT port data flow.

The RS-232 cable length for each port should not exceed 15 meters, although longer cable lengths are permitted if the load capacitance measured at a connection point (including signal terminator) does not exceed 2500 pF.

### **5-11. RS-232 UUT Port Setup Procedure**

Complete the following procedure to set up the SERIAL 2 TO UUT port (defaults in **bold**). The RS-232 parameters you are selecting must match the RS-232 parameters of the UUT. This port operates independently, whether the 5500A Calibrator is controlled from the IEEE-488 port or from the RS-232 Host serial port. (See Figures 5-1 and 5-2.)

1. Turn the 5500A Calibrator power on. You may operate the calibrator during warmup, but specifications are not guaranteed until warmup is complete.
2. Press the **SETUP** key on the 5500A Calibrator front panel.
3. Negotiate the softkey selections shown below to configure the UUT serial port to match the settings of the UUT RS-232 port. The factory defaults (shown below in **bold**) are 9600 baud, 8 data bits, 1 stop bit, and no parity. Other parameters include flow control (STALL).

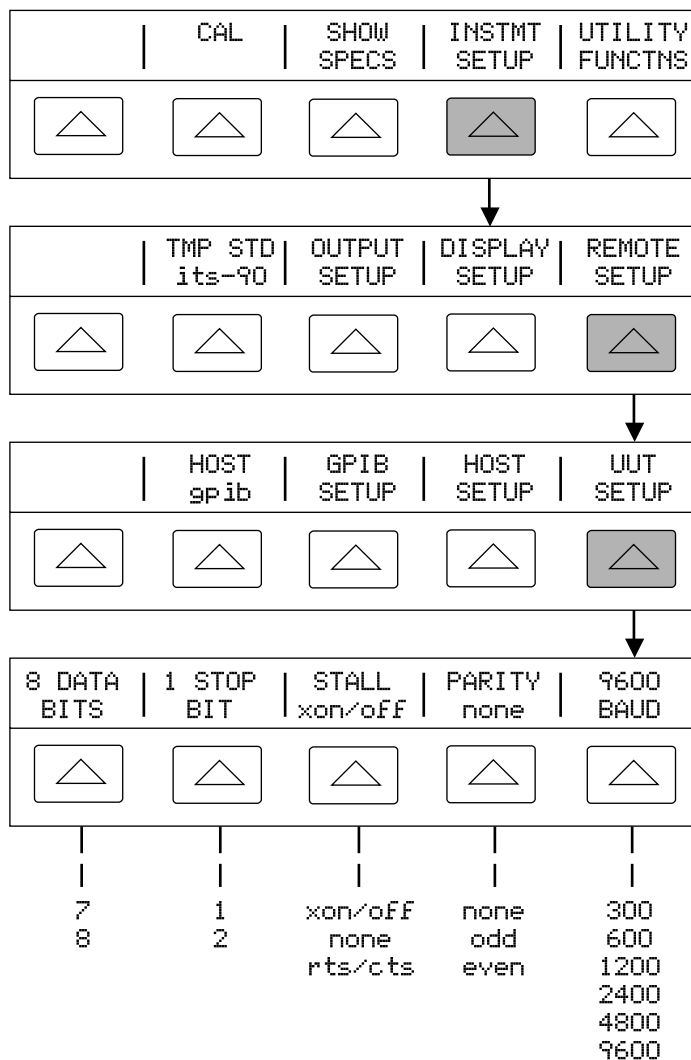

gl45f.eps

**5-12. Testing the RS-232 UUT Port via RS-232 Host Port**

Choose or adapt one of the following test procedures to test the 5500A Calibrator RS-232 UUT port via the RS-232 Host port. Connect the UUT and PC as shown in Figure 5-5. Note the use of a modem cable (NOT null modem) for UUT connection. (See Appendix D for information about RS-232 cables and connectors.)

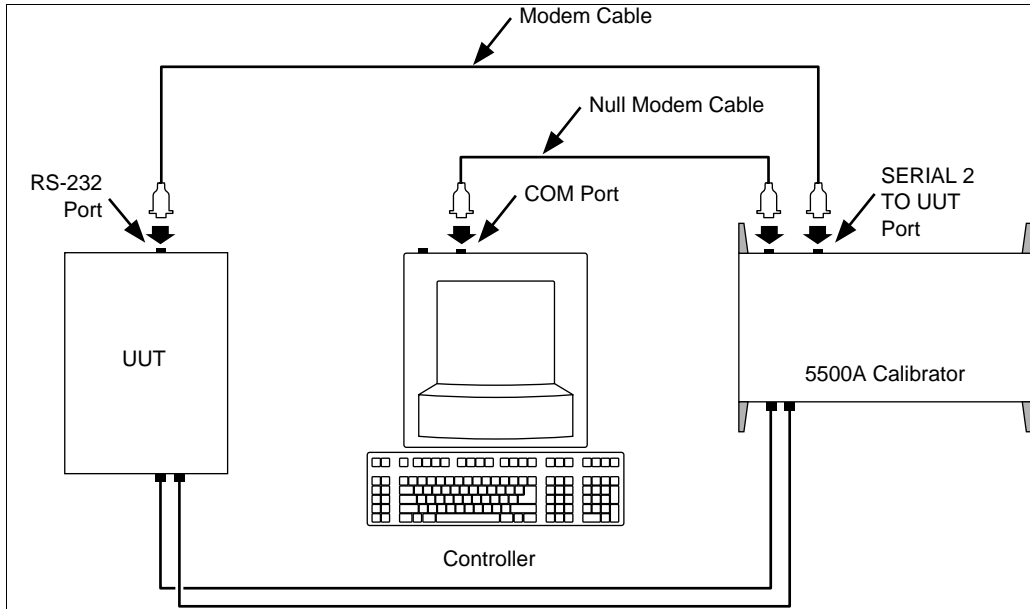

**Figure 5-5. Typical RS-232 UUT Port via RS-232 Host Port Connections**

F5-0i.eps

**Terminal** This procedure uses the Terminal accessory supplied with Windows (or equal) to test RS-232 UUT port operation.

**Visual Basic** This procedure uses Visual Basic (see Appendix E) to test RS-232 Host port and RS-232 UUT port operation.

**5-13. Testing RS-232 UUT Port Operation via a Terminal**

Complete the following procedure to test RS-232 UUT port operation via the RS-232 Host port using the Windows Terminal accessory (or equal).

1. Complete "RS-232 UUT Port Setup Procedure" to the 5500A RS-232 UUT port to match the parameters of the UUT RS-232 port.
2. Complete "Testing RS-232 Host Port Operation using a Terminal" to set up the 5500A RS-232 Host port to match the parameters of the PC COM port. After Step 9, return to this procedure and continue to Step 3 below.
3. On the Terminal screen, type `UUT_SEND "<uut command>"` where `<uut command>` is the command you selected for the UUT response, then press `<Enter>`. Observe the UUT responds. For example, to send the command `REMS` to a UUT, use `UUT_SEND "REMS\n"` and press `<Enter>`.

Note the use of `\n`, which indicates a Carriage Return (CR) as the end-of-line character. Other characters include `\r` (Line Feed), `\t` (Tab), `\b` (Backspace) and `\f` (Form Feed). If your UUT commands require an end-of-line character, select one or more of the above.

The characters UUT\_SEND "<uut command>" should have appeared as they were entered. If they did not appear on the screen, the RS-232 interface between the PC and 5500A Host port is not operating. Review the "RS-232 Host Port Setup Procedure" and correct the problem.

If the UUT command does not execute, refer to step 3 of the "RS-232 UUT Port Setup Procedure" procedure to verify the RS-232 UUT port parameters. Also check the cable for UUT connection was a modem (not null modem) cable. Be sure your command was entered correctly had the proper end-of-line character(s), if required.

4. When finished testing UUT commands, select the Exit command from the File menu to close the Terminal accessory.

#### 5-14. Testing RS-232 UUT Port Operation using Visual Basic

Complete the following procedure to test RS-232 UUT port operation via the RS-232 Host port using a Visual Basic test program. This procedure assumes you have already completed Appendix E, "Creating a Visual Basic Test Program" to create the program used for this test.

Complete the following procedure to test RS-232 operation using Visual Basic.

1. Complete the "RS-232 UUT Port Setup Procedure" earlier in this chapter to set up the 5500A RS-232 UUT port to match the parameters of the UUT RS-232 port.
2. Complete "Testing RS-232 Host Port Operation using Visual Basic" to prepare the 5500A Calibrator RS-232 Host port. After Step 6, return to this procedure and continue to Step 3 below.
3. Click the Command3 button (below is typical). Observe the UUT responds to the command you used when you completed Appendix E, "Creating a Visual Basic Test Program."

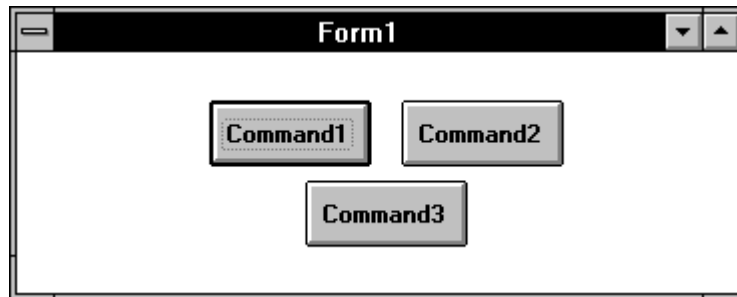

F5-0h.bmp

If the UUT did not respond, check the RS-232 parameters set for the 5500A Calibrator UUT port and set for the UUT port. Verify you used a modem (not null modem) cable for the 5500A to UUT connection. Check the Visual Basic program to make sure the UUT command was entered correctly, including the end-of-line character, if any.

4. Close the program by clicking the top-left corner and Close.

**5-15. Testing the RS-232 UUT Port via IEEE-488 Port**

This procedure uses the Win32 Interactive Control utility supplied by National Instruments with the recommended interface cards. Connect the UUT, Calibrator, and PC as shown in Figure 5-6. Note the use of a modem cable (NOT null modem) for the UUT connection.

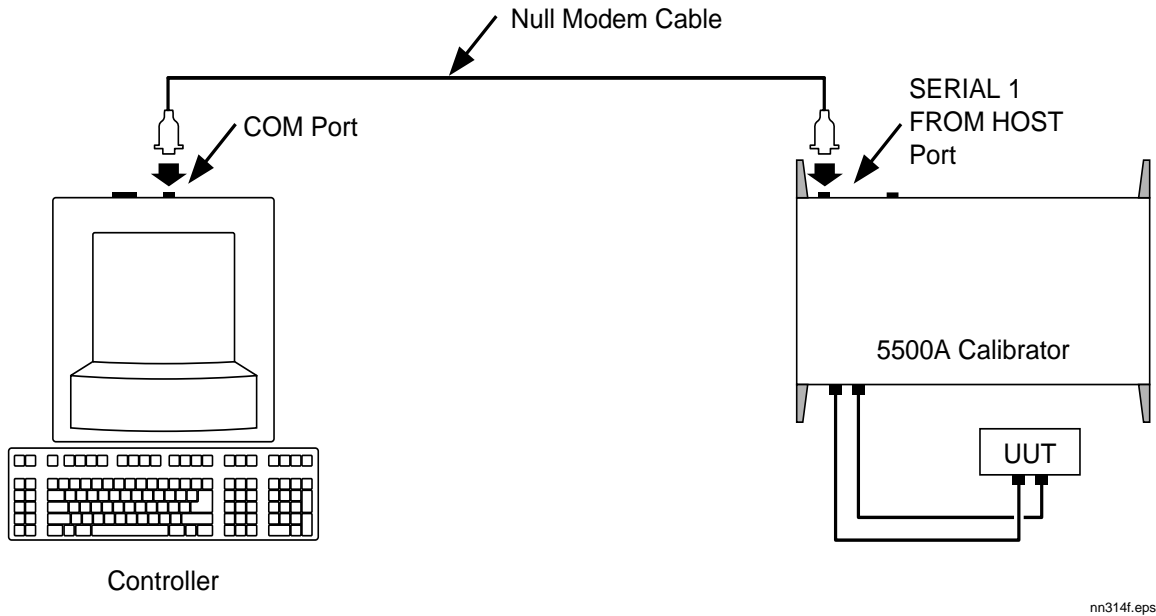

**Figure 5-6. Typical RS-232 UUT Port via IEEE-488 Port Connections**

Complete the following procedure to test RS-232 UUT port operation via the IEEE-488 port using the Win32 Interactive Control utility.

1. Complete the "IEEE-488 Port Setup Procedure" earlier in this chapter to set up the 5500A for GPIB operation.
2. Complete "Testing the IEEE-488 Port" to prepare the Calibrator IEEE-488 port for testing. Before the final step, return to this procedure and continue to Step 3 below.
3. Go to Start, then to the Programs menu.
4. Select "NI-488.2M software for... (your operating system)".
5. From the NI488.2M software menu, select "Win32 interactive control". A DOS window opens with a prompt as shown below:

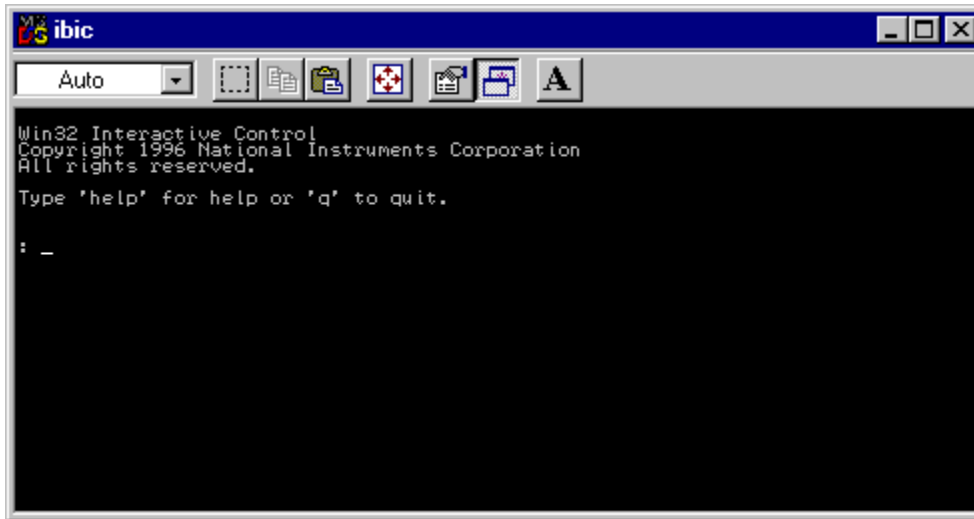

6. At the prompt, type the following line to activate the IEEE interface card:

```
<ibdev 0 4 0 10 1 0>
```

The second number in this line is the primary address of the calibrator. If the address has been changed from the factory default, change this line accordingly.

7. The prompt reads <ud0:>. From this prompt, type

```
<ibwrt "uut_sendb 82,69,77,83,11,13">
```

8. Press the ENTER (or RETURN) key. This command will send REMS<CR><LF> to the UUT serial port. After the command is entered, the Win32 Interactive Control shows the status of the command. If an error is encountered, check the typing or consult the National Instruments manual regarding Win32 Interactive control. The count message is the amount of characters sent over the bus.

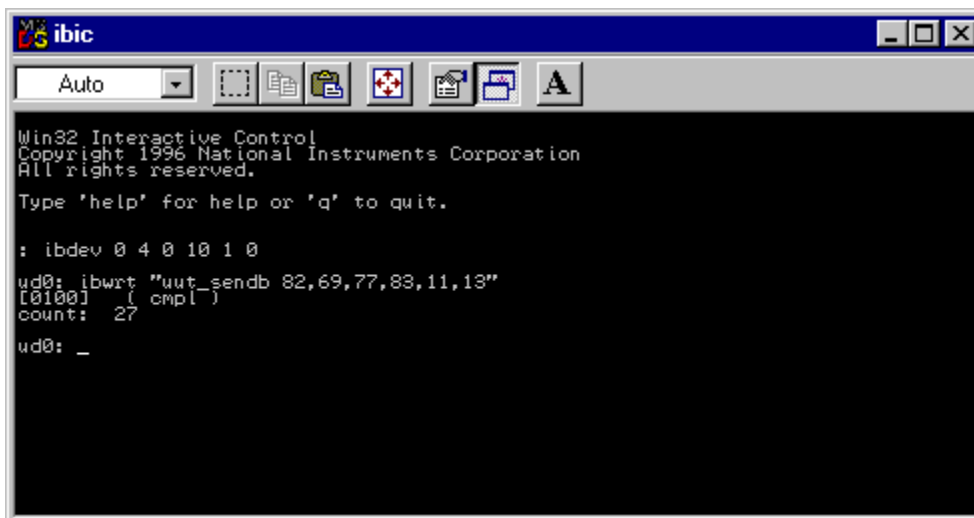

9. Verify that the UUT is in remote.  
10. From the ud0: prompt type <q> then press the ENTER (or RETURN) key.



## 5-16. Changing between Remote and Local Operation

In addition to local mode (front panel operation) and remote, the 5500A Calibrator can be placed in a local lockout condition at any time by command of the controller. Combined, the local, remote, and lockout conditions yield four possible operating states described as follows.

### 5-17. Local State

The 5500A Calibrator responds to local and remote commands. This is normal front panel operation. All remote commands are allowed to execute.

### 5-18. Local with Lockout State

Local with lockout is identical to local, except the 5500A Calibrator will go into the remote with lockout state instead of the remote state when it receives a remote command.

### 5-19. Remote State

When the 5500A Calibrator is placed in remote, either via RS-232 REMOTE command, or via IEEE-488 asserting the REN line, it enters the remote state. In the remote state, the Output Display continues to display the output setting or measurement as in local operation. The Control Display changes to:

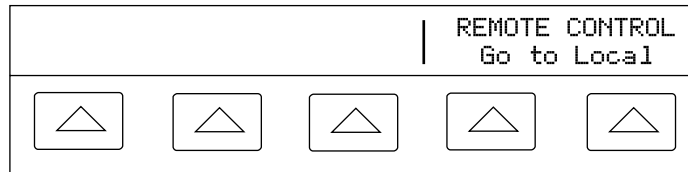

gl41f.eps

The left side of the Control Display shows information regarding the present output function. However, front panel operation is restricted to use of the power switch and the "Go To Local" softkeys. Pressing either of these softkeys, using RS-232 to send the command LOCAL, or IEEE-488 to send the GTL (Go To Local) message returns the 5500A Calibrator to the local state.

### 5-20. Remote with Lockout State

When the 5500A Calibrator is placed in lockout, either via RS-232 LOCKOUT command, or via the IEEE-488 message LLO, the 5500A front panel controls are totally locked out. In remote with lockout, the Control Display changes to:

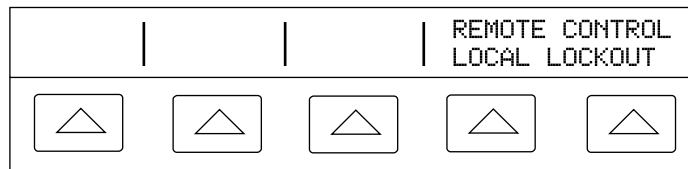

gl46f.eps

The left side of the Control Display shows information regarding the present output function. However, front panel operation is restricted to use of the power switch. To return the 5500A Calibrator to the local with lockout state, send the RS-232 LOCAL command or the IEEE-488 GTL (Go To Local) message and unasserts the REN line.

Table 5-1 summarizes the possible Remote/Local state transitions. (For more information on IEEE-488 GPIB messages, see “IEEE-488 Overview.”)

**Table 5-1. Operating State Transitions**

From	To	Front Panel	GPIB Message	Serial Command
Local	Remote		MLA (REN True)	REMOTE
	Local with Lockout		LLO	LOCKOUT
Remote	Local	Go to Local softkey	GTL or REN False	LOCAL
	Remote with Lockout		LLO	LOCKOUT
Local with Lockout	Local		REN False	LOCAL
	Remote with Lockout		MLA (REN True)	REMOTE
Remote with Lockout	Local		REN False	LOCAL
	Local with Lockout		GTL	

## 5-21. RS-232 Interface Overview

The two 5500A Calibrator RS-232 ports are designed in accordance with EIA (Electronic Industries Association) standard RS-232-C. RS-232 is a serial binary data interchange operating from 300 to 9600 baud (selectable), and distances up to 50 feet. The 5500A Calibrator rear panel SERIAL 1 FROM HOST port is configured as DTE (Data Terminal Equipment) while the SERIAL 2 TO UUT is configured as DCE (Data Communications Equipment). See Appendix D for RS-232 cable and connector information. For detailed information, see the EIA standard RS-232-C.

A summary of RS-232 terms, interface lines and mnemonics are shown in Table 5-2.

**Table 5-2. RS-232 Interface Wiring**

Mnemonic	Description
CTS	Clear to Send
DB-9	Type DB connector, 9 pins
DB-25	Type DB connector, 25 pins
DCD	Data Carrier Detect
DCE	Data Communications Equipment
DSR	Data Set Ready
DTE	Data Terminal Equipment
DTR	Data Terminal Ready
GND	Ground
RI	Ring Indicator
RLSD	Received Line Signal Detector
RTD	Request to Send
RX	Receive Line
TX	Transmit Line

## 5-22. IEEE-488 Interface Overview

The IEEE-488 parallel interface sends commands as data and receives measurements and messages as data. The maximum data exchange rate is 1 Mbyte, with a maximum distance of 20 meters for the sum length of the connecting cables. A single cable should not exceed 4 meters in length. Some commands are reserved for RS-232 serial operation because these functions must be implemented as IEEE messages per the IEEE Standards. For example, the command REMOTE could be sent as data over the IEEE-488 interface to place the 5500A Calibrator into remote, but it is not because the IEEE Standards call for the remote function to be sent to the device as the uniline message REN. This is also true for several other commands and functions, as shown below, with their equivalent RS-232 emulation. A summary of IEEE-488 messages is shown in Table 5-3.

**Table 5-3. RS-232 Emulation of IEEE-488 Messages**

IEEE-488 Message	RS-232 Equivalent
GTL	LOCAL command
GTR	REMOTE command
LLO	LOCKOUT command
SDC, DCL	^C (<Cntl> C) character [clear the device]
GET	^T (<Cntl> T) character [execute a group trigger]
SPE, SPD	^P (<Cntl> P) character [print the serial poll string]
UNL, UNT	(not emulated on RS-232)

The IEEE-488 interface is based on the IEEE Standards 488.1 and 488.2. For detailed information, refer to the standards IEEE-488.1 and IEEE-488.2.

**IEEE-488.1** IEEE-488.1 is the hardware portion of the interface. The parallel signal lines are divided into eight lines for the data bus, three lines for the handshake, and five lines for bus management. The handshake lines take care of the timing for data exchange. The bus management lines control the operation of data exchange. The ATN line indicates the use of the DIO lines for addresses or messages (true), or for DIO data (false). The EOI line is used with the data lines to mark the end of a message, and with the ATN line for polling. The SRQ line is used by the devices to indicate to the controller that they require service. The IFC line is used by the controller to quickly get all the devices on the bus to stop talking and start listening. The REN line is used to implement the remote/local states.

**IEEE-488.2** IEEE-488.2 is the software portion of the interface, specifying data formats, common commands, message exchange protocol and the status register implementation.

Use the following to decode the columns in Figure 5-7. Appendix D shows a typical IEEE-488 connector and pin assignments.

- |       |  |   |
|-------|--|---|
| Type  | M - Multiline<br>U - Uniline   |   |
| Class | AC - Addressed Command<br>AD - Address (Talk or listen)<br>UC - Universal Command<br>ST - Status | DD - Device Dependent<br>HS - Handshake<br>SE - Secondary |
| Other | B1, B2, etc. - Information Bits<br>Blanks - Doesn't Care condition                               | Logic Zero = 0 = False<br>Logic One = 1 = True            |

MESSAGE DESCRIPTION				DATA BUS								HAND-SHAKE			BUS MANAGEMENT							
M N E M	MESSAGE NAME	T Y P E	C L A S S	D	D	D	D	D	D	D	D	D A V	N R F D	N D A C	A	E	S	I	R			
				8	7	6	5	4	3	2	1				T	O	R	Q	F	C	N	
ACG	Addressed Command Group	M	AC	0	0	0												1				
ATN	Attention	U	UC															1				
DAB	Data Byte	M	DD	B8	B7	B6	B5	B4	B3	B2	B1							0				
DAC	Data Accepted	U	HS											0								
DAV	Data Valid	U	HS									1										
DCL	Device Clear	M	UC	0	0	1	0	1	0	0								1				
END	End	U	ST															0	1			
EOS	End Of String	M	DD	B8	B7	B6	B5	B4	B3	B2	B1							0				
GET	Group Execute Trigger	M	AC	0	0	0	1	0	0	0								1				
GTL	Go To Local	M	AC	0	0	0	0	0	0	1								1				
IDY	Identify	U	UC																1			
IFC	Interface Clear	U	UC																		1	
LAG	Listen Address Group	M	AD	0	1													1				
LLO	Local Lock Out	M	UC	0	0	1	0	0	0	1								1				
MLA	My Listen Address	M	AD	0	1	B5	B4	B3	B2	B1								1				
MTA	My Talk Address	M	AD	1	0	B5	B4	B3	B2	B1								1				
MSA	My Secondary Address	M	SE	1	1	B5	B4	B3	B2	B1								1				
NUL	Null Byte	M	DD	0	0	0	0	0	0	0												
OSA	Other Secondary Address	M	SE	(OSA = SCG ^ MSA-NOT)																		
OTA	Other Talk Address	M	AD	(OTA = TAG ^ MTA-NOT)																		
PCG	Primary Command Group	M	----	(PCG = ACG • UCG • LAG • TAG)																		
PPC	Parallel Poll Configure	M	AC	0	0	0	0	1	0	1								1				
PPE	Parallel Poll Enable	M	SE	1	1	0	B4	B3	B2	B1								1				
PPD	Parallel Poll Disable	M	SE	1	1	1	B4	B3	B2	B1								1				
PPR1	Parallel Poll Response 1	U	ST								1							1	1			
PPR2	Parallel Poll Response 2	U	ST								1							1	1			
PPR3	Parallel Poll Response 3	U	ST							1								1	1			
PPR4	Parallel Poll Response 4	U	ST				1											1	1			
PPR5	Parallel Poll Response 5	U	ST			1												1	1			
PPR6	Parallel Poll Response 6	U	ST			1												1	1			
PPR7	Parallel Poll Response 7	U	ST	1														1	1			
PPR8	Parallel Poll Response 8	U	ST	1														1	1			
PPU	Parallel Poll Unconfigure	M	UC	0	0	1	0	1	0	1								1				
REN	Remote Enable	U	UC																			1
RFD	Ready For Data	U	HS										0									
RQS	Request For Service	U	ST	1														0				
SCG	Secondary Command Group	M	SE	1	1													1				
SDC	Selected Device Clear	M	AC	0	0	0	0	1	0	0								1				
SPD	Serial Poll Disable	M	UC	0	0	1	1	0	0	1								1				
SPE	Serial Poll Enable	M	UC	0	0	1	1	0	0	0								1				
SRQ	Service Request	U	ST																	1		
STB	Status Byte	M	ST	B8	B6	B5	B4	B3	B2	B1								0				
TCT	Take Control	M	AC	0	0	0	1	0	0	1								1				
TAG	Talk Address Group	M	AD	1	0													1				
UCG	Universal Command Group	M	UC	0	0	1												1				
UNL	Unlisten	M	AD	0	1	1	1	1	1	1								1				
UNT	Untalk	M	AD	1	0	1	1	1	1	1								1				

Figure 5-7. IEEE-488 Remote Message Coding

## 5-23. Using Commands

Communications between the controller and the 5500A Calibrator consists of commands, queries, and interface messages. Although the commands are based on the 488.2 standard, they can be used on either the IEEE-488 or RS-232 interface, except for a few specialized RS-232 commands described in “Commands for RS-232 Only.” (For more information on command structures, see the IEEE 488.2 standard.)

Refer to Chapter 6, “Remote Commands” when you require additional information about command references used this chapter.

All commands and units may be entered in UPPER or lower case.

There are four specific remote control configurations that use commands, queries and interface messages: IEEE-488, RS-232 Terminal Mode, RS-232 Computer Mode, and RS-232 Pass-Through Mode. (Setting up and testing each mode is discussed earlier in this chapter.)

**IEEE-488 Mode** The IEEE-488 mode is used when the 5500A Calibrator is operated by computer program. In this mode, requested information is returned by query, and interface messages are queued and returned by command.

**RS-232 Terminal Mode** The RS-232 terminal mode is an interactive mode where an operator inputs commands, with immediate returns for requested information (queries) and interface messages.

**RS-232 Computer Mode** The RS-232 computer mode is used when the 5500A Calibrator is operated by computer program. In this mode, requested information is returned by query, and interface messages are queued and returned by command.

**RS-232 Pass-Through Mode** The RS-232 pass-through mode is used to pass commands from the PC to a UUT, but via the 5500A Calibrator. This configuration is used when the UUT has an RS-232 port. Commands are sent to the UUT by using the UUT\_SEND command, returns use the UUT\_RECV? query, and UUT\_FLUSH clears the UUT receive buffer in the 5500A Calibrator.

## 5-24. Types of Commands

The commands for the 5500A Calibrator can be grouped into one or more categories, depending on how they function. Each category is described below.

## 5-25. Device-Dependent Commands

Device-dependent commands are unique to the 5500A Calibrator. An example of a device-dependent command is,

```
OUT 100 V, 1 A, 60 HZ
```

instructing the 5500A Calibrator to source 100 watts of ac power.

### 5-26. Common Commands

Common commands are defined by the IEEE 488.2 standard and are common to most bus devices. Common commands always begin with an \* character. Common commands are available whether you are using the IEEE-488 or RS-232 interface for remote control. An example of a common command is,

```
*IDN?
```

instructing the 5500A Calibrator to return the instrument identification string.

### 5-27. Query Commands

Query commands request information, which is returned as the command executes, or placed in a buffer until requested. An example of a query, which always ends with a question mark, is,

```
RANGE?
```

returning the 5500A Calibrator primary and secondary outputs.

### 5-28. Interface Messages (IEEE-488)

Interface messages manage traffic on the IEEE-488 interface bus. Device addressing and clearing, data handshaking, and commands to place status bytes on the bus are all directed by interface messages. Some of the interface messages occur as state transitions of dedicated control lines. The rest of the interface messages are sent over the data lines with the ATN signal true. (All device-dependent and common commands are sent over the data lines with the ATN signal false.)

An important thing to note about interface messages is that unlike device-dependent and common commands, interface messages are not sent literally (in a direct way). For example, when you send a device-dependent query to the 5500A Calibrator, the controller automatically sends the interface message MTA (My Talk Address).

IEEE-488 standards define interface messages. Table 5-4 lists the interface messages that the 5500A Calibrator accepts. Table 5-4 also shows the BASIC statement to generate the interface message. Table 5-5 lists the interface messages that the calibrator sends. The mnemonics listed in the tables are not sent in BASIC PRINT statements as commands are; in this way they are different from device-dependent and common commands.

Interface messages are handled automatically in most cases. For example, handshake messages DAV, DAC, and RFD automatically occur under the direction of an instrument's interface itself as each byte is sent over the bus.

**Table 5-4. IEEE-488 Interface Messages (Receive)**

Mnemonic	Name	Function
ATN	Attention	A control line that, when asserted, notifies all instruments on the bus that the next data bytes are an interface message. When ATN is low, the next data bytes are interpreted as device-dependent or common commands addressed to a specific instrument.
DAC	Data Accepted	Sets the handshake signal line NDAC low.
DAV	Data Valid	Asserts the handshake signal line DAV.
DCL	Device Clear	Clears the input/output buffers
END	End	A message that occurs when the Controller asserts the EOI signal line before sending a byte.
GET	Group Execute Trigger	Trigger a TC measurement and put the reading in the output buffer.
GTL	Go To Local	Transfer control of the 5500A from one of the remote states to one of the local states. (See Table 5-1)
LLO	Local Lockout	Transfers remote/local control of the 5500A. (See Table 5-1)
IFC	Interface Clear	A control line that sets the interface to a quiescent state.
MLA	My Listen Address	Addresses a specific device on the bus as a listener. The controller sends MLA automatically whenever it directs a device-dependent or common command to a specific instrument.
MTA	My Talk Address	Addresses a specific device on the bus as a talker. The controller sends MTA automatically whenever it directs a device-dependent or common query to a specific instrument.
REN	Remote Enable	Transfer remote/local control of the 5500A. (See Table 5-1)
RFD	Ready For Data	Sets the handshake signal line NRFD low.
SDC	Selected Device Clear	Does the same thing as DCL, but only if the 5500A is currently addressed as a listener.
SPD	Serial Poll Disable	Cancel the effect of a Serial Poll Enable.
SPE	Serial Poll Enable	After the 5500A receives this message, it sends the Status Byte the next it is addressed as a listener, no matter what the command is.
UNL	Unlisten	"Unaddresses" a specific device on the bus as a listener. The controller sends UNL automatically after the device has successfully received a device-dependent or common command.
UNT	Untalk	"Unaddresses" a specific device on the bus as a listener. The controller sends UNL automatically after the device has successfully received a device-dependent or common query.

Table 5-5. IEEE-488 Interface Messages (Send)

Mnemonic	Name	Function
END	End	A message that occurs when the 5500A asserts the EOI control line. The 5500A asserts EOI while it transmits the ASCII character LF for its termination sequence or terminator.
DAC	Data Accepted	Set the handshake signal line NDAC low.
DAV	Data Valid	Asserts the handshake signal line DAV.
RFD	Ready for Data	Sets the handshake line NRFD low.
SRQ	Service Request	A control line that any device on the bus can assert to indicate that it requires attention. Refer to "Checking 5500A Status" for details.
STB	Status Byte	The status byte is what the 5500A sends when it responds to a serial poll (interface message SPE).

### 5-29. Compound Commands

A compound command is two or more commands in a single command line. For example, the following two commands could be entered individually,

```
OUT 1 V, 60 Hz
OPER
```

where the 5500A Calibrator sources 1 V ac at 60 Hz, and then goes into operate, or they could be combined into a compound command,

```
OUT 1 V, 60 HZ ; OPER
```

using a semi-colon as a separator. Care must be taken when a compound command includes any of the coupled commands. (See "Coupled Commands.")

### 5-30. Coupled Commands

A coupled command refers to two or more commands that appear in a compound command (see "Compound Commands") that perform actions that could interfere with each other causing a fault. Commands in a compound command are separated by using the ; character. Compound commands using only coupled commands are not order-dependent.

In Chapter 6, the command graphic shows a check mark for  Coupled commands.

The five coupled commands are:

```
CUR_POST    HARMONIC    WAVE
DC_OFFSET   OUT
```

An example of coupled command interference is the command

```
OUT 1 V ; RANGELCK ON
```

followed by the command

```
OUT 10 V ; RANGELCK OFF
```

which can't be executed because RANGELCK ON in the first command locks the dc volts range, preventing the command OUT 10 V from executing. With a different order

```
RANGELCK OFF ; OUT 10 V
```

the second compound command can be executed successfully.



### 5-31. Overlapped Commands

Commands that begin execution but require slightly more time to complete are called overlapped commands, because they can be overlapped by the next command before they have completed execution.

In Chapter 6, the command graphic shows a check mark for  Overlapped commands.

The 25 overlapped commands are:

BOOST	RANGELCK
CUR_POST	*RST
DC_OFFSET	RTD_TYPE
DPF	SCOPE
DUTY	SRC_PREF
EARTH	STBY
HARMONIC	TC_OFFSET
INCR	TC_OTCD
LOWS	TC_REF
MULT	TC_TYPE
OPER	TRIG
OUT	TSENS_TYPE
OUT_IMP	WAVE
PHASE	ZCOMP

You can use the command \*WAI to wait until the overlapped command has completed execution before executing the next command. For example,

```
OUT 1 V, 1 A, 60 HZ ; *WAI
```

You can also use the status commands \*OPC and \*OPC? to detect completion of overlapped commands. (See “Checking 5500A Status.”)

### 5-32. Sequential Commands

Commands that execute immediately are called sequential commands.

In Chapter 6, the command graphic shows a check mark for  Sequential commands.

The majority of the commands, 87 of 111 commands, are sequential.

### 5-33. Commands that Require the Calibration Switch to be Enabled

The following commands do not work unless the rear panel CALIBRATION switch is in the ENABLE position:

```
FORMAT ALL  
FORMAT CAL  
*PUD
```

Attempting to use any of these commands with the CALIBRATION switch in the NORMAL position logs an error into the error queue. (Or it returns the error message if in the RS-232 Terminal Mode.)

### 5-34. Commands for RS-232 Only

Commands that are used for the RS-232 interface only are identified in the command graphic by checking the  IEEE-488  RS-232 check box.

The IEEE-488 and RS-232 interfaces both send commands to the 5500A Calibrator as data, except for those IEEE-488 functions that must be implemented as a message as specified in the IEEE-488 standards. For example, the RS-232 interface uses the command REMOTE to place the 5500A Calibrator in the remote mode. Although the IEEE-488 interface could also send a command REMOTE as data, it does not because this is one of the functions that must be implemented per IEEE-488 Standards.

The relationship between these IEEE-488 messages and the equivalent RS-232 emulation is shown in Table .

**Table 5-6. Commands for RS-232 Only**

IEEE-488 Message [1]	RS-232 Equivalent
GTL	LOCAL command
GTR	REMOTE command
LLO	LOCKOUT command
SRQ	SRQSTR command
SDC, DCL	^C (<Cntl> C) character [clear the device]
GET	^T (<Cntl> T) character [execute a group trigger]
SPE, SPD	^P (<Cntl> P) character [print the serial poll string]
[1] See "How IEEE-488 Operates" later in this chapter.	

In addition to the commands and special characters that emulate the IEEE-488 functions shown above, there are several more commands that are related to operation and control of the actual RS-232 Host port and are therefore completely unrelated to IEEE-488 operations. These include the following six commands.

SP_SET	SPLSTR	SRQSTR
SP_SET?	SPLSTR?	SRQSTR?

### 5-35. *Commands for IEEE-488 Only*

Commands that are used for the IEEE-488 interface are identified in the command graphic by checking the  IEEE-488 check box. This is all the commands, except for those used for RS-232 operations. (See "Commands for RS-232 Only.") All commands are transferred over the IEEE-488 as data, except for the commands LOCAL, REMOTE, and LOCKOUT, which are implemented per IEEE Standards as messages (see Table 5-7).

**Table 5-7. Commands for IEEE-488 Only**

IEEE-488 Message [1]	Command Representation
GTL	LOCAL command
GTR	REMOTE command
LLO	LOCKOUT command
SDC, DCL	Clear the device
GET	Execute a group trigger
SPE, SPD	Print the serial poll string
[1] See "How IEEE-488 Operates" later in this chapter.	

**5-36. Command Syntax**

The following syntax rules apply to all the remote commands. Information about syntax of response messages is also given.

**5-37. Parameter Syntax Rules**

Table 5-8 lists the vocabulary of units accepted in command parameters and used in responses. All commands and units may be entered in UPPER or lower case.

**Table 5-8. Units Accepted in Parameters and Used in Responses**

Units	Meaning
HZ	Frequency in units of hertz
KHZ	Frequency in units of kilohertz
MHZ	Frequency in units of megahertz
UV	Volts in units of microvolts
MV	Volts in units of millivolts
V	Volts in units of volts
KV	Volts in units of kilovolts
UA	Current in units of microamperes
MA	Current in units of milliamps
A	Current in units of amps
PCT	Percent
PPM	Parts-per-million
DBM	Volts in units of decibels referenced to 1 milliwatt into 600Ω load
OHM	Resistance in units of ohms
KOHM	Resistance in units of kilohms
MOHM	Resistance in units of megohms
NF	Capacitance in units of nanofarads
PF	Capacitance in units of picofarads
UF	Capacitance in units of microfarads
MF	Capacitance in units of millifarads
F	Capacitance in units of farads
CEL	Temperature in degrees Celsius
FAR	Temperature in degrees Fahrenheit
NS	Period in units of nanoseconds
US	Period in units of microseconds
MS	Period in units of milliseconds
S	Period in units of seconds

**General Rules** The general rules for parameter usage is as follows:

1. When a command has more than one parameter, the parameters must be separated by commas. For example: OUT 1V, 2A.
2. Numeric parameters may have up to 15 significant digits and their exponents can be in the range +/-1.0E+/-20.
3. Including too many or too few parameters causes a command error.
4. Null parameters cause an error, e.g., the adjacent commas in OUT 1V, , 2A.
5. Expressions, for example 4+2\*13, are not allowed as parameters.
6. Binary Block Data can be in one of two forms: Indefinite Length and Definite Length format (both IEEE-488.2 standards).

**Indefinite Length** The Definite Length format accepts data bytes after the #0 until the ASCII Line Feed character is received with an EOI signal (for RS-232 just a line feed or carriage return will terminate the block).

**Definite Length** The Definite Length format specifies the number of characters that will follow in the <digits> field. These characters must be 0 to 9 (ASCII 48 to 57 decimal). The value of the number in the <digits> field defines the number of user data bytes that will follow in the <user data> field. For examples, see the UUT\_SEND and \*PUD command descriptions in Chapter 6.

### 5-38. *Extra Space or Tab Characters*

In the command descriptions in Chapter 6, parameters are shown separated by spaces. One space after a command is required (unless no parameters are required). All other spaces are optional. Spaces are inserted for clarity in the manual and may be left in or omitted as desired. You can insert extra spaces or tabs between parameters as desired. Extra spaces within a parameter are generally not allowed, except for between a number and its associated multiplier or unit. Chapter 6 contains examples for commands whose parameters or responses are not self-explanatory.

**5-39. Terminators**

Table 5-9 summarizes the terminator characters for both the IEEE-488 and RS-232 remote interfaces.

**Table 5-9. Terminator Characters**

Terminator Function	ASCII Character		Control Command Terminator	Language Command Terminator
	Number	Program		
Carriage Return (CR)	13	Chr(13)	<Cntl> M	\n
Line Feed (LF)	10	Chr(10)	<Cntl> J	\r
Backspace (BS)	8	Chr(8)	<Cntl> H	\b
Form Feed (FF)	12	Chr(12)	<Cntl> L	\f
Examples:				
RS-232 Terminal Mode	OUT 1 V, 60 Hz		<Enter>	
	UUT_SEND "REMS\n"		<Enter>	
	UUT_SEND #205REMS^M		<Enter> (^M means <Cntl> M)	
RS-232 Computer Mode (typical to Visual Basic)	Comm1.Output = "OUT 1 V, 60 HZ" + Chr(10)			
	Comm1.Output = "UUT_SEND ""REMS\n"" " + Chr(10)			
IEEE-488 Mode (command only)	OUT 1 V, 60 Hz			
	UUT_SEND "REMS\n"			

**IEEE-488 Interface** The 5500A Calibrator sends the ASCII character Line Feed with the EOI control line held high as the terminator for response messages. The calibrator recognizes the following as terminators when encountered in incoming data:

- ASCII LF character
- Any ASCII character sent with the EOI control line asserted

**RS-232 Interface** The 5500A Calibrator returns an EOL (End of Line) character with each response to the PC. This is selectable as Carriage Return (CR), Line Feed (LF) or both CRLF. (See "RS-232 Host Port Setup Procedure" earlier in this chapter.) Commands sent to the 5500A Calibrator must end in either a CR or LF, not both. (See Table 5-9 above.)

**5-40. Incoming Character Processing**

The 5500A Calibrator processes all incoming data as follows (except Binary Block Data as described under Parameter Syntax Rules):

1. The most significant data bit (DIO8) is ignored.
2. All data is taken as 7-bit ASCII.
3. Lower-case or upper-case characters are accepted.
4. ASCII characters whose decimal equivalent is less than 32 (Space) are discarded, except for characters 10 (LF) and 13 (CR) and in the \*PUD command argument. Binary Block Data allows all characters in its argument and terminates in a special way.

### 5-41. Response Message Syntax

In the command descriptions in Chapter 6, responses from the 5500A Calibrator are described wherever appropriate. In order to know what type of data to read in, refer to the first part of the entry under "Response" in the tables. The response is identified as one of the data types in Table 5-10.

**Table 5-10. Response Data Types**

DATA TYPE	DESCRIPTION
Integer	Integers for some controllers or computers are decimal numbers in the range -32768 to 32768. Responses in this range are labeled Integer. Example:        *ESE 123; *ESE? returns:        123
Floating	Numbers that may have up to 15 significant figures plus an exponent that may range from $\pm E20$ . Example:        DC_OFFSET? returns:        1.4293E+00
String	Any ASCII characters including quotation mark delimiters. Example:        SRQSTR "SRQ from 5500A"; SRQSTR? returns:        "SRQ from 5500A"
Character Response Data (CRD)	This type of response is always a keyword. Example:        OUT 10V, 100HZ; FUNC? returns:        ACV
Indefinite ASCII (IAD)	Any ASCII characters followed by EOM. Queries with this type of response MUST be the last Query in a program message. Example:        *OPT? returns:        5725A CAL reports and lists which contains Line Feeds are typically of this type.
Binary Block Data	A special data type defined by the IEEE-488.2 standard. This type is used in *PUD? query. It is defined as follows: #(non-zero digit) (digits) (user data) The non-zero digit specifies the number of characters that will follow in the <digits> field. Characters allowed in the digits field are 0 through 9 (ASCII 48 through 57 decimal). The value of the number in the <digits> field in decimal defines the number of user data bytes that follow in the <user data> field. The maximum response is 64 characters. Example:        *PUD "test1"; *PUD? returns:        #205test1

## 5-42. Checking 5500A Status

The programmer has access to status registers, enable registers, and queues in the 5500A Calibrator to indicate various conditions in the instrument as shown in Figure 5-8. Some registers and queues are defined by the IEEE-488.2 standard. The rest are specific to the calibrator. In addition to the status registers, the Service Request (SRQ) control line, and a 16-element buffer called the Error Queue provide status information. Table 5-11 lists the status registers and gives the read/write commands and associated mask registers.

**Table 5-11. Status Register Summary**

Status Register	Read Command	Write Command
Serial Poll Status Byte (STB)	*STB?	—
Service Request Enable Register (SRE)	*SRE?	*SRE
Event Status Register (ESR)	*ESR?	—
Event Status Enable Register (ESE)	*ESE?	*ESE
Instrument Status Register (ISR)	ISR?	—
Instrument Status Change Register (ISCR)	ISCR?	—
ISCR 1 to 0 transition	ISCR0?	—
ISCR 0 to 1 transition	ISCR1?	—
Instrument Status Change Enable Register (ISCE)	ISCE?	ISCE
ISCE 1 to 0 transition	ISCE0?	ISCE0
ISCE 0 to 1 transition	ISCE1?	ISCE1

Each status register and queue has a summary bit in the Serial Poll Status Byte. Enable registers are used to mask various bits in the status registers and generate summary bits in the Serial Poll Status Byte. For IEEE-488 interface operation, the Service Request Enable Register is used to assert the SRQ control line on detection of any status condition or conditions the programmer chooses. For RS-232 interface operation, the SRQSTR string is sent over the serial interface when the SRQ line is set. (See the SRQSTR command description in Chapter 6 for more information.)

## 5-43. Serial Poll Status Byte (STB)

The 5500A Calibrator sends the serial poll status byte (STB) when it responds to a serial poll. This byte is cleared (set to 0) when the power is turned on. The value of this byte at power-on is determined by the value of the service request enable register (SRE), which is saved in nonvolatile memory. The STB byte is defined as shown in Figure 5-9. If you are using the RS-232 as the remote control interface, transmitting the ^P character (in the Terminal mode, hold down the <Cntl> key and press P) returns the SPLSTR (Serial Poll String) and the status byte. Refer to the \*STB command, and for RS-232 interface operation, the SPLSTR and SPLSTR? commands, in Chapter 6 for more information.

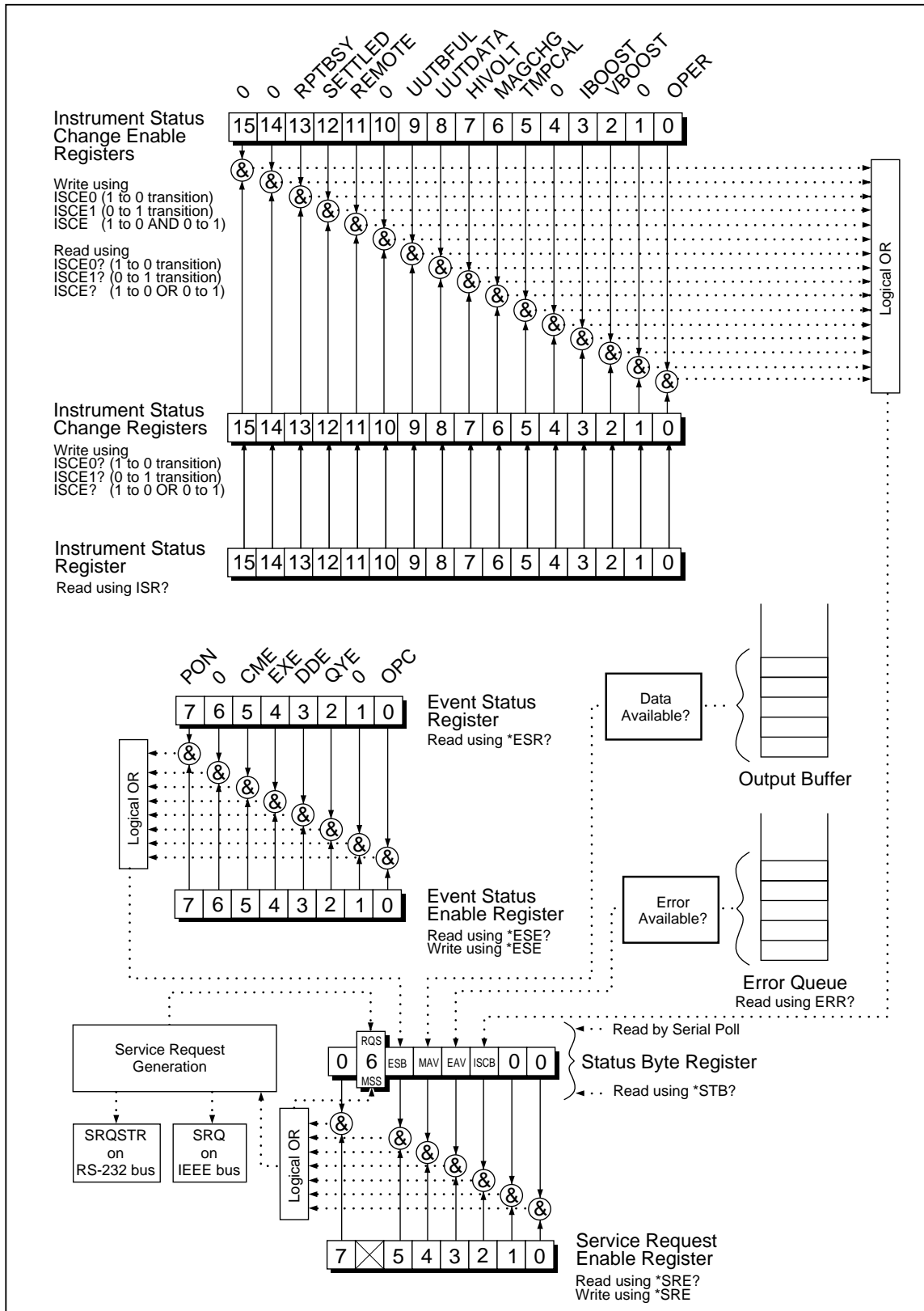

Figure 5-8. Status Register Overview

F5-04.eps



7	6	5	4	3	2	1	0
<b>0</b>	<b>RQS</b> <b>MSS</b>	<b>ESB</b>	<b>MAV</b>	<b>EAV</b>	<b>ISCB</b>	<b>0</b>	<b>0</b>

RQS Requesting service. The RQS bit is set to 1 whenever bits ESB, MAV, EAV, or ISCB change from 0 to 1 and are enabled (1) in the SRE. When RQS is 1, the 5500A asserts the SRQ control line on the IEEE-488 interface. You can do a serial poll to read this bit to see if the 5500A is the source of an SRQ.

MSS Master summary status. Set to 1 whenever bits ESB, MAV, EAV, or ISCB are 1 and enabled (1) in the SRE. This bit can be read using the \*STB? command in serial remote control in place of doing a serial poll.

ESB Set to 1 when one or more enabled ESR bits are 1.

MAV Message available. The MAV bit is set to 1 whenever data is available in the 5500A's IEEE-488 interface output buffer.

EAV Error available. An error has occurred and an error is available to be read from the error queue by using the ERR? query.

ISCB One or more enabled ISCR bits are 1.

F5-05.eps

**Figure 5-9. Serial Poll Status Byte (STB) and Service Request Enable (SRE)**

**5-44. Service Request (SRQ) Line**

**IEEE-488** Service Request (SRQ) is an IEEE-488.1 bus control line that the 5500A Calibrator asserts to notify the controller that it requires some type of service. Many instruments can be on the bus, but they all share a single SRQ line. To determine which instrument set SRQ, the Controller normally does a serial poll of each instrument. The calibrator asserts SRQ whenever the RQS bit in its Serial Poll Status Byte is 1. This bit informs the controller that the calibrator was the source of the SRQ.

**RS-232** Remote operations using the RS-232 interface emulate the IEEE-488 SRQ line by sending the SRQSTR string over the serial interface when the SRQ line is set. (See the SRQSTR command description in Chapter 6 for more information.)

The 5500A Calibrator clears SRQ and RQS whenever the controller/host performs a serial poll, sends \*CLS, or whenever the MSS bit is cleared. The MSS bit is cleared only when ESB, MAV, EAV, and ISCB are 0, or they are disabled by their associated enable bits in the SRE register being set to 0.

**5-45. Service Request Enable Register (SRE)**

The Service Request Enable Register (SRE) enables or masks the bits of the Serial Poll Status Byte. The SRE is cleared at power up. Refer to Figure 5-9 for the bit functions.

#### 5-46. Programming the STB and SRE

By resetting (to 0) the bits in the SRE, you can mask (disable) associated bits in the serial poll status byte. Bits set to 1 enable the associated bit in the serial poll status byte. The following sample BASIC program enables the Error Available (EAV) bit.

```
10 ! THIS PROGRAM SETS EAV IN THE SRE
20 PRINT @6, "*SRE 8"           ! LOAD THE REGISTER
30 PRINT @6, "*SRE?"           ! ASK FOR THE SRE CONTENTS
40 INPUT @6, A%                 ! RETRIEVE THE REGISTER CONTENTS
50 PRINT "SRE = ";A%
60 RETURN
```

The following BASIC program generates an error and checks the Serial Poll Status Byte. Enable the EAV bit with the example above.

```
10 ! THIS PROGRAM GENERATES AN ERROR AND CHECKS IT
20 PRINT @6, "OUT 1300V"        ! 1300V IS OUT OF 5500A RANGE
30 A% = SPL(6)                  ! DO A SERIAL POLL
40 IF ((A% AND 72%)=0%) THEN PRINT "EAV and RQS should have been set"
50 PRINT @6, "*STB?"           ! RETRIEVE BYTE
60 INPUT @6, A%
70 IF ((A% AND 8%)=0%) THEN PRINT "EAV should have been set"
```

#### 5-47. Event Status Register (ESR)

The Event Status Register is a two-byte register in which the higher eight bits are always 0, and the lower eight bits represent various conditions of the 5500A Calibrator. The ESR is cleared (set to 0) when the power is turned on, and every time it is read.

Many of the remote commands require parameters. Improper use of parameters causes command errors to occur. When a command error occurs, bit CME (5) in the Event Status Register (ESR) goes to 1 (if enabled in ESE register), and the error is logged in the error queue.

#### 5-48. Event Status Enable (ESE) Register

A mask register called the Event Status Enable register (ESE) allows the controller to enable or mask (disable) each bit in the ESR. When a bit in the ESE is 1, the corresponding bit in the ESR is enabled. When any enabled bit in the ESR is 1, the ESB bit in the Serial Poll Status Byte also goes to 1. The ESR bit stays 1 until the controller reads the ESR or does a device clear, a selected device clear, or sends the reset or \*CLS command to the calibrator. The ESE is cleared (set to 0) when the power is turned on.

#### 5-49. Bit Assignments for the ESR and ESE

The bits in the Event Status Register (ESR) and Event Status Enable register (ESE) are assigned as shown in Figure 5-10.

15	14	13	12	11	10	9	8
0	0	0	0	0	0	0	0

7	6	5	4	3	2	1	0
<b>PON</b>	<b>0</b>	<b>CME</b>	<b>EXE</b>	<b>DDE</b>	<b>QYE</b>	<b>0</b>	<b>OPC</b>

PON Power on. This bit is set to 1 if line power has been turned off and on since the last time the ESR was read.

CME Command error. The 5500A's IEEE-488 interface encountered an incorrectly formed command. (The command ERR? fetches the earliest error code in the error queue, which contains error codes for the first 15 errors that have occurred.)

EXE Execution error. An error occurred while the 5500A tried to execute the last command. This could be caused, for example, by a parameter being out of range. (The command ERR? fetches the earliest error in the error queue, which contains error codes for the first 15 errors that have occurred.)

DDE Device-dependent error. An error related to a device-dependent command has occurred.

QYE Query error. The 5500A was addressed to talk when no response data was available or appropriate, or when the controller failed to retrieve data on the output queue.

OPC Operation complete. All commands previous to reception of a \*OPC command have been executed, and the interface is ready to accept another message.

F5-06.eps

**Figure 5-10. Event Status Register (ESR) and Event Status Enable (ESE)**

**5-50. Programming the ESR and ESE**

To read the contents of the ESR, send the remote command, \*ESR?. The ESR is cleared (set to 0) every time it is read. To read the contents of the ESE, send the remote command, \*ESE?. The ESE is not cleared when it is read. When you read either register, the 5500A Calibrator responds by sending a decimal number that when converted to binary represents bits 0 through 15. The following sample BASIC program retrieves the contents of both registers:

```

10 ! THIS PROGRAM READS THE ESR AND THE ESE REGISTERS
20 PRINT @6, "*ESR?"           ! ASK FOR THE ESR CONTENTS
30 INPUT @6, A%                ! RETRIEVE THE REGISTER CONTENTS
40 PRINT @6, "*ESE?"          ! ASK FOR THE ESE CONTENTS
50 INPUT @6, B%                ! RETRIEVE THE REGISTER CONTENTS
60 PRINT "ESR = ";A%           ! DISPLAY THE ESR REGISTER CONTENTS VALUE
70 PRINT "ESE = ";B%           ! DISPLAY THE ESE REGISTER CONTENTS VALUE
80 END

```

Convert the contents of variables A and B into binary, and you can read the status of the registers. For example if A is 32, its binary equivalent is: 00000000 00100000. Therefore, bit 5 (CME) in the ESR is set (1) and the rest of the bits are reset (0). This means that the calibrator tried to execute an incorrectly formed command.

By setting the bits in the ESE, you can mask (disable) the associated bits in the ESR. For example, to prevent the occurrence of a command error from causing bit 5 (ESB) in the serial poll status byte to go to 1, you can reset (to 0) bit 5 in the ESE register. The following sample program accomplishes this by checking the status of the CME bit, then toggling it if it is 1.

```
10 ! THIS PROGRAM RESETS BIT 5 (CME) IN THE ESE
20 PRINT @6, "*ESE 33" ! INITIAL ESE IS CME + OPC
30 GOSUB 100 ! GET AND PRINT INITIAL ESE
40 IF (A% AND 32%) THEN A% = A% - 32% ! CLEAR CME (BIT 5)
50 PRINT @6, "*ESE ";A% ! LOAD ESE WITH NEW VALUE
60 GOSUB 100 ! GET AND PRINT NEW ESE
70 END
100 PRINT @6, "*ESE?" ! ASK FOR ESE CONTENTS
110 INPUT @6, A% ! RETRIEVE REGISTER CONTENTS
120 PRINT "ESE = ";A%
130 RETURN
```

### **5-51. Instrument Status Register (ISR)**

The Instrument Status Register (ISR) gives the controller access to the state of the 5500A Calibrator, including some of the information presented to the operator on the Control Display and the display annunciators during local operation.

### **5-52. Instrument Status Change Registers**

There are two registers dedicated to monitoring changes in the ISR. These are the ISCR0 (Instrument Status 1-0 Change Register) and the ISCR1 (Instrument Status 0-1 Change Register). Each status change register has an associated mask register. Each ISCR is cleared (set to 0) when the 5500A Calibrator is turned on, every time it is read, and at each \*CLS (Clear Status) command.

### **5-53. Instrument Status Change Enable Registers**

The Instrument Status Change Enable registers (ISCE0 and ISCE1) are mask registers for the ISCR0 and ISCR1 registers. If a bit in the ISCE is enabled (set to 1) and the corresponding bit in the ISCR makes the appropriate transition, the ISCB bit in the Status Byte is set to 1. If all bits in the ISCE are disabled (set to 0), the ISCB bit in the Status Byte never goes to 1. The contents of the ISCE registers are set to 0 at power-up.

### **5-54. Bit Assignments for the ISR, ISCR, and ISCE**

The bits in the Instrument Status, Instrument Status Change, and Instrument Status Change Enable registers are assigned as shown in Figure 5-11.

15	14	13	12	11	10	9	8
<b>0</b>	<b>0</b>	<b>RPTBUSY</b>	<b>SETTLED</b>	<b>REMOTE</b>	<b>0</b>	<b>UUTBFUL</b>	<b>UUTDATA</b>

7	6	5	4	3	2	1	0
<b>HIVOLT</b>	<b>MAGCHG</b>	<b>TMPCAL</b>	<b>0</b>	<b>IBOOST</b>	<b>VBOOST</b>	<b>0</b>	<b>OPER</b>

RPTBUSY	Set to 1 when a calibration report is being printed to the serial port.
SETTLED	Set to 1 when the output has stabilized to within specification or the TC measurement has settled and is available.
REMOTE	Set to 1 when the 5500A is under remote control.
UUTBFUL	Set to 1 when data from the UUT port has filled up the UUT buffer.
UUTDATA	Set to 1 when there is data available from the UUT port.
HIVOLT	Set to 1 when the 5500A is programmed to a voltage above 33 Volts.
MAGCHG	Set to 1 when the output magnitude has changed as a result of another change (e.g. RTD_TYPE). This bit is always 0 in the ISR. It changes to 1 only in the ISCR0 and ISCR1 registers.
TMPCAL	Set to 1 when the 5500A is using temporary (non-stored) calibration data.
IBOOST	Set to 1 when an auxiliary amplifier is sourcing a current.
VBOOST	Set to 1 when an auxiliary amplifier is sourcing a voltage.
OPER	Set to 1 when the 5500A is in operate, 0 when it is in standby.

**Figure 5-11. Bit Assignments for the ISR, ISCEs and ISCRs**

F5-07.eps

### 5-55. Programming the ISR, ISCR, and ISCE

To read the contents of the ISR, send the remote command, ISR?. To read the contents of the ISCR0 or 1, send the remote command, ISCR0?, or ISCR1?. To read the contents of the ISCE0 or 1, send the remote command, ISCE0?, or ISCE1?. The 5500A Calibrator responds by sending a decimal number that represents bits 0 through 15. Every time you read the ISCR0 or 1, its contents are zeroed. The following sample program reads all five registers:

```
10 ! THIS PROGRAM READS THE ISR, ISCR, AND ISCE REGISTERS
20 ! NOTE THAT THE ICSR? COMMANDS CLEAR THE ISCR CONTENTS
30 PRINT @6, "ISR?" ! ASK ISR CONTENTS
40 INPUT @6, A% ! RETRIEVE REGISTER CONTENTS FROM 5500A
50 PRINT @6, "ISCR0?" ! ASK FOR AND CLEAR ISCR0 CONTENTS
60 INPUT @6, B% ! RETRIEVE REGISTER CONTENTS FROM 5500A
70 PRINT @6, "ISCE0?" ! ASK FOR ISCE0 CONTENTS
80 INPUT @6, C% ! RETRIEVE REGISTER CONTENTS FROM 5500A
50 PRINT @6, "ISCR1?" ! ASK FOR AND CLEAR ISCR1 CONTENTS
60 INPUT @6, D% ! RETRIEVE REGISTER CONTENTS FROM 5500A
70 PRINT @6, "ISCE1?" ! ASK FOR ISCE1 CONTENTS
80 INPUT @6, E% ! RETRIEVE REGISTER CONTENTS FROM 5500A
90 PRINT "ISR = ";A% ! DISPLAY ISR
100 PRINT "ISCR0 = ";B% ! DISPLAY ISCR0
110 PRINT "ISCE0 = ";C% ! DISPLAY ISCE0
100 PRINT "ISCR1 = ";D% ! DISPLAY ISCR1
110 PRINT "ISCE1 = ";E% ! DISPLAY ISCE1
120 END
```

Convert the returned variables into binary, and you can read the status of the instrument. For example if a register contains 4, its binary equivalent is: 00000000 00000100. Therefore, bit 3 (VBOOST) is set (1) and the rest of the bits are reset (0).

By setting the bits in an ISCE register, you can mask (disable) the associated bits in the ISCR. For example, to cause an SRQ interrupt when the output has settled, bit 12 (SETTLED) in the ISCE1 register must be 1. (The ISCB bit must also be enabled in the SRE.) The following sample program loads a decimal 1024 into the ISCE, which sets bit 12 and resets the other bits:

```
10 ! THIS PROGRAM LOADS 00010000 00000000 BINARY INTO THE ISCE
20 PRINT @6, "ISCE 4096" ! LOAD DECIMAL 4096 INTO ISCE
30 PRINT @6, "ISCE?" ! READ BACK ISCE VALUE
40 INPUT @6, A% ! "
50 PRINT "ISCE = ";A% ! PRINT IT, IT SHOULD BE 4096
60 END
```

### 5-56. Output Queue

The output queue is loaded whenever a query is processed, and holds up to 800 characters. The controller reads it with a statement such as a BASIC INPUT statement, removing what it reads from the queue. If the queue is empty, the 5500A Calibrator does not respond to the INPUT statement from the controller. The Message Available (MAV) bit in the Serial Poll Status Byte is 1 if there is something in the output queue and 0 if the output queue is empty.

### 5-57. Error Queue

When a command error, execution error, or device-dependent error occurs, its error code is placed in the error queue where it can be read by the ERR? command. (See Appendix F for a list of error messages.) A way to decode an error code is to send the command, EXPLAIN?, which returns a description of a error code. Reading the first error with the ERR? command removes that error from the queue. A response of 0 means the error queue is empty. The Error Available (EAV) bit in the Serial Poll Status Byte indicates whether the queue is empty. The error queue is cleared when you turn off the power, and when you use the \*CLS (Clear Status) common command.

The error queue contains up to 16 entries. If many errors occur, only the first 15 errors are kept in the queue. A 16th entry in the queue is always an "error queue overflow" error, and all later errors are discarded until the queue is at least partially read. The first errors are kept, because if many errors occur before the user can acknowledge and read them, the earliest errors are the most likely to point to the problem. The later errors are usually repetitions or consequences of the original problem.

### 5-58. Remote Program Examples

The following programming examples illustrate ways to handle errors, to take measurements, take a number of successive readings, lock the range, and calibrate the calibrator. These excerpts from programs are written in DOS BASIC.

### 5-59. Guidelines for Programming the Calibrator

Commands are processed one at a time as they are received. Some commands require a previous condition be set before the command will be accepted by the 5500A Calibrator. For example, the waveform must be SQUARE before the DUTY command will be accepted. Using the following programming guidelines will insure that the output is programmed to the desired state.

- All external connections commands should be programmed first. The calibrator will be placed in standby and the output may be changed to accommodate the new external connection. The setting may be set even if the present output does not use the setting (for example, setting the current post while sourcing voltage).
- The output and output mode should be programmed next with the OUT command.
- All other output parameters such as impedance compensation, offset, and waveforms should be programmed next. The DUTY command must follow the WAVE command.
- The error status should be checked with the ERR? command. The calibrator will not process the OPER command if an unacknowledged error exists.
- Finally, the calibrator should be placed in operate with the OPER command.

A controller program first needs to initialize the interface and the 5500A Calibrator. Refer to following sample program:

```
10 INIT PORT 0 \ REMOTE @6      ! PUT THE 5500A INTO THE REMOTE STATE
20 PRINT @6, "*RST;OUT 10V;OPER" ! RESET THE 5500A, PROGRAM IT TO
                                ! OUTPUT 10 VOLTS DC
```

If you wish to use SRQs, first use the \*SRE, \*ESE, and ISCE commands to enable the desired event. Refer to "Checking 5500A Status."

You retrieve instrument parameters with a query (a programming command that ends with a question mark):

```
200 PRINT @6, "FUNC?"           ! RETRIEVE OUTPUT FUNCTION
210 INPUT LINE @6, A$
220 PRINT "Function is: "; A$
230 PRINT @6, "ONTIME?"         ! RETRIEVE ON TIME
240 INPUT LINE @6, A$
250 PRINT "The instrument has been on for "; A$;" hours"
```

This program generates the following sample output:

```
Function is: DCV
The instrument has been on for 0 days, 02:23:58 hours
```

Check for programming errors as in the following sample programs. Check the Error Available (EAV) bit in the serial poll register using a serial poll.

```
300 A = SPL(6)                   ! CHECK FOR ERRORS
310 IF (A AND 8) THEN PRINT "There was an error"
320 PRINT @6, "*CLS"             ! CLEAR ERRORS
```

Retrieve errors and explanations as follows. Since errors are accumulated in a queue, you must read the entire queue to retrieve and clear all the errors.

```
400 PRINT @6, "ERR?"            ! CHECK FOR ERRORS
410 INPUT @6, A, A$             ! READ IN THE ERROR
420 IF (A = 0) THEN GOTO 500    ! NO MORE ERRORS
430 PRINT "Error# :";A, A$      ! PRINT ERROR# AND EXPLANATION
440 GOTO 400
500 END
```

## 5-60. Writing an SRQ and Error Handler

It is good practice to include fault (error) handling routines in your applications. The following sample program lines show a method for halting program execution on occurrence of an SRQ (Service Request) on the bus, checking to see if the calibrator is the source of the SRQ, retrieving its fault messages, and acting on the faults. You should modify and extend this code as necessary for your application.

If you want to use SRQs, first use the \*SRE, \*ESE, and ISCE commands to enable the desired event. Refer to "Checking 5500A Status" for more information.

```
10  INIT PORT0                   ! IFC the bus
20  CLEAR PORT0                 ! DCL the bus
30  ! INITIALIZE THE 5500A SRQ HANDLER
40  PRINT @6, "*SRE 8"          ! Enable STB.EAV (error available)
50  ON SRQ GOTO 1100           ! Install SRQ handler
60  ! Body of the application goes here
1100 ! Bus SRQ handler
1110 CLEAR PORT0                ! Make sure devices are not confused
1120 IF (SPL(6) AND 64) THEN GOSUB 1200 ! If (STB.RQS) call SRQ
1130 ! TEST OTHER DEVICES RQS BITS IF DESIRED
1140 RESUME
1200 ! 5500A SRQ handler
1210 IF (SPL(6) AND 8) THEN GOSUB 1300 ! If (STB.EAV) call handler
1220 ! Test other STB bits if desired here
1299 RETURN
1300 ! 5500A STB.EAV (error) handler
1320 PRINT @6, "ERR?"          ! Read and clear error
1330 INPUT @6, E%, E$          ! Read in error # and explanation
1340 PRINT "Error# :";E, E$    ! Print error # and explanation
1350 IF (E% <> 0) THEN GOTO 1320 ! Until no more errors
1360 STOP                      ! Other commands for your app
1370 END
```



### 5-61. Verifying a Meter on the IEEE-488 Bus

This program selects 10 V dc output, verifies that the 5500A Calibrator is set to 10 V, then triggers a Fluke 45 to take a reading. It displays calibrator output, Fluke 45 reading, and the meter error in ppm. The program assumes that the calibrator bus address is 4 and the Fluke 45 bus address is 1.

```

10 REM THIS PROGRAM VERIFIES THE ACCURACY OF A FLUKE 45 AT 10V DC
20 INIT PORT 0 ! INITIALIZE THE INTERFACE
30 CLEAR PORT 0 ! "
40 PRINT @1, "VDC;RATE 5;AUTO;TRIGGER 2" ! SETS FLUKE 45 TO 10V DC
50 PRINT @1, "OUT 10 V ; OPER;" ! SET THE 5500A TO 10V DC
60 PRINT @4, "*WAI; OUT?" ! WAIT FOR SETTLE, REQUEST THE OUTPUT VALUE
70 PRINT @4, "V,U$,F,V2,U2$" ! GET THE DATA FROM THE 5500A
80 PRINT @1, "*TRG;VAL?" ! TRIGGER 45 TO TAKE READING
90 INPUT @1, VM ! GET THE DATA FROM THE 45
100 ER = ABS(V - VM)/V * 1E6 ! COMPUTE ERROR
110 PRINT "5500 OUTPUT: ";V;U$ ! PRINT THE RESULTS
120 PRINT "45 MEASURED: ";VM;"V"
130 PRINT "ERROR: ";ER;"PPM"
140 END
    
```

### 5-62. Verifying a Meter on the RS-232 UUT Serial Port

This program selects 10 V dc output, verifies that the 5500A Calibrator is set to 10 V, then triggers a Fluke 45 to take a reading. It displays 5500A Calibrator output, the Fluke 45 reading, and the meter error in ppm. The program assumes that the 5500A Calibrator uses the IEEE-488 interface with bus address is 4 and the Fluke 45 is on the 5500A Calibrator SERIAL 2 TO UUT port.

```

10 REM THIS PROGRAM VERIFIES THE ACCURACY OF A FLUKE 45 AT 10V DC
20 INIT PORT 0 ! INITIALIZE THE INTERFACE
30 CLEAR PORT 0 ! "
40 PRINT @4, "UUT_SEND `VDC;RATE S;AUTO;TRIGGER 2\n'" ! SET FLUKE 45
50 PRINT @4, "UUT_RECV" ! SEND THE FLUKE 45 PROMPT
60 PRINT @4, P$ ! GET THE FLUKE 45 PROMPT
70 PRINT @4, "OUT 10 V ; OPER" ! SET THE 5500A TO 10 V DC
80 PRINT @4, "*WAI; OUT?" ! WAIT FOR SETTLE; GET VALUE
90 PRINT @4, "V,U$,F,V2,U2$" ! GET THE DATA FROM 5500A
100 PRINT @4, "UUT_SEND `*TRG; VAL?\n'" ! TRIGGER FLUKE 45 READING
110 PRINT @4, "UUT_RECV?" ! SEND 45 READING TO 5500A
120 INPUT @4, VM, P$ ! GET 45 READING AND PROMPT
130 ER = ABS (V - VM)/V * 1E6 ! COMPUTE ERROR
140 PRINT "5500 OUTPUT: ";V;U$ ! PRINT THE RESULTS
150 PRINT "FLUKE 45 MEASURED: ";ER;"PPM" ! PRINT THE RESULTS
160 END
    
```

### 5-63. Using \*OPC?, \*OPC, and \*WAI

The \*OPC?, \*OPC, and \*WAI commands let you maintain control of the order of execution of commands that could otherwise be passed up by subsequent commands.

If you had sent an OUT command, you can check if the output has settled by sending the query \*OPC?. As soon as the OUT command has completed (output settled), a "1" appears in the output buffer. You should always follow an \*OPC? command with a read command. The read command causes program execution to pause until the addressed instrument responds. The following sample program shows how you can use \*OPC?.

```

10 PRINT @4, "OUT 100V,1KHZ;OPER; *OPC?" ! 5500A ADDRESS IS 4
20 INPUT @4, A ! READ THE "1" FROM THE 5500A
30 !PROGRAM HALTS HERE UNTIL A "1" IS PUT INTO THE OUTPUT BUFFER
40 PRINT "OUTPUT SETTLED"
    
```

The \*OPC command is similar in operation to the \*OPC? query, except that it sets bit 0 (OPC for "Operation Complete") in the Event Status Register to 1 rather than sending a 1 to the output buffer. One simple use for \*OPC is to include it in the program in order for it to generate an SRQ (Service Request). Then an SRQ handler written into the program can detect the operation complete condition and respond appropriately. You can use \*OPC similarly to \*OPC?, except your program must read the ESR to detect the completion of all operations. The following sample program shows how you can use \*OPC.

```
10 REMOTE
20 PRINT @4, "OUT 100V,1KHZ;OPER;*OPC" ! 5500A ADDRESS IS 4
30 PRINT @4, "*ESR?" ! PUT THE ESR BYTE IN BUFFER
40 INPUT @4, A% ! READ THE ESR BYTE
50 IF (A% AND 1%) = 0% GOTO 30 ! TRY AGAIN IF NO OPC
60 PRINT "OUTPUT SETTLED"
70 END
```

The \*WAI command causes the 5500A Calibrator to wait until any prior commands have been completed before continuing on to the next command, and takes no other action. Using \*WAI is a convenient way to halt operation until the command or commands preceding it have completed. The following sample program shows how you can use \*WAI.

```
10 REMOTE
20 PRINT @4, "OUT 100V,1KHZ;OPER;*WAI" ! 5500A ADDRESS IS 4
30 PRINT @4, "OUT?" ! READ THE OUTPUT VALUE
40 PRINT @4, A$,B$,C$ ! A$ CONTAINS THE OUTPUT VALUE
50 PRINT "OUTPUT SETTLED"
60 PRINT "OUTPUT IS: ";A$;B$;" at ";C$
70 END
```

#### **5-64. Taking a Thermocouple Measurement**

The following program takes one measurement at a time.

```
10 REM Set Bus Timeout to 20 seconds, Init IEEE Bus
20 TIMEOUT 20 * 1000
30 INIT PORT 0
40 CLEAR @6
100 REM Reset 5500A, TC measurement mode
110 PRINT @6,"*RST; TC_TYPE J; TC_MEAS FAR"
200 PRINT "Hit Carriage Return to take a Reading"
210 INPUTLINE A$
220 REM Trigger and wait for measurement
230 PRINT @6, "*TRG"
240 REM Read measurement, unit
250 INPUT @6, M,U$
260 GOTO 200
```

#### **5-65. Using the RS-232 UUT Port to Control an instrument**

The SERIAL 2 TO UUT RS-232 port is used to pass commands on to another instrument. For example, a meter that is being calibrated can have its RS-232 port connected the calibrator SERIAL 2 TO UUT serial port. Commands sent from a controller can be routed through the calibrator's UUT port and received by the meter or UUT. There are six special UUT\_\* commands incorporated into the calibrator for passing commands on to an instrument connected to the UUT port. Refer to Chapter 6.

**5-66. Input Buffer Operation**

As the 5500A Calibrator receives each data byte from the controller, it places the bytes in a portion of memory called the input buffer. The input buffer holds up to 350 data bytes and operates in a first in, first out fashion.

**IEEE-488** The 5500A Calibrator treats the EOI IEEE-488 control line as a separate data byte and inserts it into the input buffer if it is encountered as part of a message terminator. Input buffer operation is transparent to the program running on the controller. If the controller sends commands faster than the calibrator can process them, the input buffer fills to capacity. When the input buffer is full, the calibrator holds off the IEEE-488 bus with the NRFD (Not Ready For Data) handshake line. When the calibrator has processed a data byte from the full input buffer, it then completes the handshake, allowing the controller to send another data byte. The calibrator clears the input buffer on power-up and on receiving the DCL (Device Clear) or SDC (Selected Device Clear) messages from the controller.

**RS-232** Under RS-232-C serial port remote control using ^S (<Cntl> S) XOFF protocol, the calibrator issues a ^S XOFF when the input buffer becomes 80% full. The calibrator issues a ^Q (<Cntl> Q) when it has read enough of the input buffer so that it is less than 40% full. When using RTS (Request to Send) protocol (selected as part of the “RS-232 Host Port Setup Procedure”), the serial interface asserts and unasserts RTS in response to same conditions as for XON/XOFF protocol.



# Chapter 6

## Remote Commands

	<b>Contents</b>	<b>Page</b>
6-1.	Introduction.....	6-3
6-2.	Command Summary by Function .....	6-3
6-3.	Summary of Commands and Queries .....	6-8



## 6-1. Introduction

This chapter documents the IEEE-488/RS-232 remote commands for the 5500A Calibrator. Remote commands duplicate activities that can be initiated from the front panel in local operation. Table 6-1 summarizes the commands by function. Following the summary table is a complete alphabetical listing of all commands complete with protocol details. Separate headings in the alphabetical listing provide the parameters and responses, plus an example for each command. For information on using commands, see Chapter 5, “Remote Operation.”

## 6-2. Command Summary by Function

**Table 6-1. Command Summary by Function**

<b>Error Mode Commands</b>	
EDIT	Sets the edit field. PRI is specified for the output value in single output functions and the primary output value in dual output functions.
EDIT?	Returns the edit field setting.
ERR_UNIT	Choose how UUT error is shown.
ERR_UNIT?	Return presently selected value of ERR_UNIT.
INCR	Increments or decrements the output (as selected by the edit field) and enters error mode, the same as using the output adjustment knob in local operation.
MULT	Multiplies the reference magnitude (as selected by the edit field).
NEWREF	Sets the reference value to be the present 5500A output value, the same as pressing the NEW REF key in local operation.
OLDREF	Sets the 5500A output to the previously programmed reference value, the same as pressing the ENTER key in local operation.
OUT_ERR?	Returns the UUT error computed by the 5500A after shifting the output with the INCR command.
REFOUT?	Returns the value of the reference, which is the output values of the 5500A the last time a new reference was established with an OUT, NEWREF, or MULT.
<b>External Connection Commands</b>	
CUR_POST	Selects the active binding posts for current output. This applies to current and power outputs.
CUR_POST?	Returns the active binding posts for current output.
EARTH	Select whether or not external earth ground is open or tied to the internal guard shields.
EARTH?	Return whether or not external earth ground is open or tied to the internal guard shields.
LOWS?	Return whether or not the low terminals are internally open or tied together.
LOWS	Select whether or not the low terminals are internally open or tied together for dual outputs.
RTD_TYPE	Sets the Resistance Temperature Detector (RTD) sensor type.
RTD_TYPE?	Returns the Resistance Temperature Detector (RTD) type used for RTD temperature simulations.

TC_REF	Sets whether the internal temperature sensor or an external reference value is used for Thermocouple (TC) outputs and measurements.
TC_REF?	Returns the source and value of the temperature being used as a reference for thermocouple simulation and measurement.
TC_TYPE	Sets the Thermocouple (TC) temperature sensor type.
TC_TYPE?	Returns the thermocouple (TC) sensor type used for temperature simulations and measurements.
TSENS_TYPE	Sets the temperature sensor type when the output is set to a temperature with the OUT command.
TSENS_TYPE?	Returns the temperature sensor type.
<b>Common Commands</b>	
*CLS	(Clear status.) Clears the ESR, ISCR0, ISCR1, the error queue, and the RQS bit in the status byte. This command terminates pending operation complete commands (*OPC or *OPC?).
*ESE	Loads a byte into the Event Status Enable register.
*ESE?	Returns the contents of the Event Status Enable register.
*ESR?	Returns the contents of the Event Status Register and clears the register.
*IDN?	Identification query. Returns instrument model number, serial number, and firmware revision levels for the main, front panel, inguard, and 5725A Amplifier CPUs.
*OPC	Enables setting of bit 0 (OPC for "Operation Complete") in the Event Status Register to 1 when all pending device operations are complete.
*OPC?	Returns a 1 after all pending operations are complete. This commands causes program execution to pause until all operations are complete. (See also *WAI.)
*OPT?	Returns a list of the installed hardware and software options, including any 5725A Amplifiers that are attached.
*PUD	Protected user data command. This command allows you to store a string of bytes in nonvolatile memory. This command works only when the CALIBRATION switch is in the ENABLE position.
*PUD?	Returns the contents of the *PUD (Protected User Data) memory.
*RST	Reset. Resets the state of the instrument to the power-up state. This command holds off execution of subsequent commands until it is complete. (Overlapped command.)
*SRE	Loads a byte into the Service Request Enable register (SRE).
*SRE?	Returns the byte from the Service Request Enable register.
*STB?	Returns the status byte.
*TRG	Changes the operating mode to thermocouple MEASURE, triggers a measurement, and returns the value of the measurement. This command is equivalent to sending "TC_MEAS;*OPC;VAL?".
*TST?	Initiates a series of self-tests, then returns a "0" for pass or a "1" for fail. If any faults are detected, they are logged into the fault queue where they can be read by the ERR? query.
*WAI	Wait-to-Continue command. This command prevents further remote commands from being executed until all previous remote commands have been executed.



<b>Output Commands</b>	
BOOST	Activates and deactivates a 5725A Amplifier and sets the source preference to the 5725A Amplifier or to the 5500A Calibrator.
BOOST?	Returns whether or not the 5725A Amplifier is in use and which output is being boosted.
CFREQ?	Returns the optimum frequency value for stimulus for capacitance modes.
DC_OFFSET	Applies a DC offset to an AC output voltage.
DC_OFFSET?	Returns the DC offset voltage.
DPF	Sets the displacement power factor (phase angle) between the NORMAL and AUX terminals for AC power output only.
DPF?	Returns the displacement power factor (phase angle) between the NORMAL and AUX terminals.
DUTY	Sets the duty cycle of SQUARE wave outputs.
DUTY?	Returns the duty cycle.
FUNC?	Returns the present output, measurement, or calibration function.
HARMONIC	Make the frequency of one output be a harmonic (multiple) of the other output (called the fundamental).
HARMONIC?	Returns the present instrument harmonic and fundamental locations.
OPER	Activates the 5500A output if it is in standby.
OPER?	Returns the operate/standby setting.
OUT	Sets the output of the 5500A and establishes a new reference point for the error mode.
OUT?	Returns the output amplitudes and frequency of the 5500A.
PHASE	Sets the phase between the NORMAL and AUX terminals for dual outputs. The NORMAL terminal output is the phase reference.
PHASE?	Returns the phase between the NORMAL and AUX terminals.
POWER?	Returns the equivalent power for DC and AC power output.
RANGE?	Returns the present output ranges.
RANGELCK	Locks in the present range, or selects auto ranging.
RANGELCK?	Returns whether or not the preset output range is locked.
STBY	Puts the 5500A in standby.
WAVE	Sets the waveforms for AC outputs.
WAVE?	Returns the waveforms of the output.
ZCOMP	Activate (2-wire or 4-wire) or deactivate impedance compensation.
ZCOMP?	Returns whether or not impedance compensation is active and if active, which type.

<b>RS-232 Host Port Commands</b>	
LOCAL	Puts the 5500A into the local state.
LOCKOUT	Puts the 5500A into the lockout state. This command duplicates the IEEE-488 LLO (Local Lockout) message.
REMOTE	Puts the 5500A into the remote state. This command duplicates the IEEE-488 REN (Remote Enable) message.
SPLSTR	Sets the serial remote mode Serial Poll response string.
SPLSTR?	Returns the string programmed for serial remote mode Serial Poll responses.
SRQSTR	Sets the serial remote mode SRQ (Service Request) response (up to 40 characters).
SRQSTR?	Returns the string programmed for Serial Mode SRQ response.
^P (<cntl>p)	Control-P character prints the serial poll string. (See SPLSTR for string format.)
^C (<cntl>c)	Control-C character clears the device.
^T (<cntl>t)	Control-T character executes a group trigger.
<b>Oscilloscope Commands</b>	
OUT_IMP	Sets the output impedance of the SCOPE BNC.
OUT_IMP?	Returns the output impedance of the SCOPE BNC.
SCOPE	Sets the calibrator output to an oscilloscope mode.
SCOPE?	Returns the present oscilloscope mode.
TRIG	Sets the frequency of the signal at the TRIG OUT BNC.
TRIG?	Returns the frequency of the signal at the TRIG OUT BNC.
<b>Setup and Utility Commands</b>	
FORMAT	<b>Use with extreme care.</b> Restores the contents of the nonvolatile memory device to factory defaults.
LIMIT	Sets the maximum permissible output magnitudes, negative and positive.
LIMIT?	Returns the programmed output magnitude limits for voltage and current.
ONTIME?	Returns the time since the 5500A was powered up last.
PR_RPT	Prints the Stored, Active, or CAL-Constant CAL_Report through either the HOST or UUT Serial Port.
RTD_TYPE_D	Set the default Resistance Temperature Detector (RTD) sensor type.
RTD_TYPE_D?	Returns the default Resistance Temperature Detector (RTD) sensor type.
SP_SET	Sets the RS-232-C serial port settings and saves them in nonvolatile memory. The settings apply only to HOST port.
SP_SET?	Returns the HOST serial port settings contained in nonvolatile memory.
SRC_PREF	Sets the source preference when a 5725A Amplifier is attached.
SRC_PREF?	Returns the source preference setting.
TC_TYPE_D	Sets the default thermocouple sensor type.
TC_TYPE_D?	Returns the thermocouple type used for thermocouple temperature simulations.
TEMP_STD	Sets the temperature degree standard, ipts-68 or its-90.
TEMP_STD?	Returns the temperature degree standard, ipts-68 or its-90.

<b>Status Commands</b>	
ERR?	Returns the first error code contained in the 5500A error queue, then removes that error code from the queue.
EXPLAIN?	Explains an error code. This command returns a string that explains the error code furnished as the parameter.
FAULT?	Returns the first error code contained in the 5500A error queue, then removes that error from the queue.
ISCE	Loads two bytes into both the Instrument Status 1 to 0 Change Enable register and the Instrument Status 0 to 1 Change Enable register.
ISCE?	Returns the OR of the contents of the Instrument Status 1 to 0 Change Enable register and the Instrument Status 0 to 1 Change Enable register.
ISCE0	Loads two bytes into the Instrument Status 1 to 0 Change Enable register.
ISCE0?	Returns the contents of the Instrument Status 1 to 0 Change Enable register.
ISCE1	Loads two bytes into the Instrument Status 0 to 1 Change Enable register.
ISCE1?	Returns the contents of the Instrument Status 0 to 1 Change Enable register.
ISCR?	Returns the OR of the contents of the Instrument Status 1 to 0 Change Register and the Instrument Status 0 to 1 Change Register and clears both registers.
ISCR0?	Returns and clears the contents of the Instrument Status 1 to 1 Change Register.
ISCR1?	Returns and clears the contents of the Instrument Status 0 to 0 Change Register.
ISR?	Returns the contents of the Instrument Status Register.
<b>Thermocouple (TC) Measurement Commands</b>	
TC_MEAS	Changes the operating mode to thermocouple MEASUREMENT.
TC_OFFSET	Sets a temperature offset for the thermocouple measurement mode.
TC_OFFSET?	Returns the temperature offset when in the thermocouple measurement mode.
TC_OTCD?	Returns whether or not the open thermocouple detection circuit is set.
TC_OTCD	Activates or deactivates the open thermocouple detection circuit in thermocouple measurement mode.
VAL?	Returns the last thermocouple (TC) measurement value.
VVAL?	Return the last value of the Thermocouple measurement in volts.
<b>RS-232 UUT Port Commands</b>	
UUT_FLUSH	Flush the UUT receive buffer.
UUT_RECV?	Return data from the UUT serial port.
UUT_SEND	Sends a string to the UUT serial port.
UUT_SET	Sets the UUT serial port settings and saves them in nonvolatile memory.
UUT_SET?	Returns the UUT serial port settings contained in nonvolatile memory.

### 6-3. Summary of Commands and Queries

The following is an alphabetical list of all 5500A Calibrator commands and queries, including common commands and device-dependent commands. Each command title includes a graphic that indicates remote interface applicability, IEEE-488 and RS-232, and command group: Sequential, Overlapped, and Coupled.

**IEEE-488 (GPIB) and RS-232 Applicability**     IEEE-488     RS-232    Each command and query has a check box indicating applicability to IEEE-488 (general purpose interface bus, or GPIB) and RS-232 remote operations. For sorting purposes, this list ignores the \* character that precedes the common commands.

**Sequential Commands**     Sequential    Commands executed immediately as they are encountered in the data stream are called sequential commands. For more information, see “Sequential Commands” in Chapter 5.

**Overlapped Commands**     Overlapped    Commands that require additional time to execute are called overlapped commands because they can overlap the next command before completing execution. To be sure an overlapped command is not interrupted during execution, use the \*OPC, \*OPC?, and \*WAI commands to detect command completion. For more information, see “Overlapped Commands” in Chapter 5.

**Coupled Commands**     Coupled    The commands OUT, WAVE, DC\_OFFSET, CUR\_POST, and HARMONIC are coupled commands because they “couple” in a compound command sequence. Care must be taken to be sure the action of one command does not disable the action of a second command and thereby cause a fault. For more information, see “Coupled Commands” in Chapter 5.

---

**BOOST**     IEEE-488     RS-232     Sequential     Overlapped     Coupled

(Boost command) Activate or deactivate a 5725A Amplifier and set the source preference to the 5725A Amplifier or to the 5500A Calibrator. An error is reported if the 5725A Amplifier cannot be turned on or off for the present output.

Parameters:    ON    (activates the connected 5725A Amplifier)  
                  OFF    (deactivates the connected 5725A Amplifier)

Example:    BOOST ON

Activate the connected 5725A Amplifier if the last OUT command selected an output supported by the connected 5725A Amplifier.

---

**BOOST?**     IEEE-488     RS-232     Sequential     Overlapped     Coupled

(Boost query) Return whether or not the 5725A Amplifier is in use for the output and which output is being boosted.

Responses:    VOLTAGE    (sourced by the 5725A Amplifier)  
                  CURRENT    (sourced by the 5725A Amplifier)  
                  OFF    (not sourced by the 5725A Amplifier)

Example:    BOOST? returns OFF

Return OFF when the 5725A Amplifier is not in use, or not connected.

---

**CAL\_ABORT**  IEEE-488  RS-232  Sequential  Overlapped  Coupled

(Calibration Abort query) Instruct 5500A to abort calibration procedure after present step.

Example: CAL\_ABORT

---

**CAL\_CONST?**  IEEE-488  RS-232  Sequential  Overlapped  Coupled

(Calibration Constant command/query) Retrieves the value in use of the given calibration constant.

Parameter: The name of the calibration constant

Response: (float) The value of the constant

Example: CAL\_CONST? VDAC\_G

---

**CAL\_DATE?**  IEEE-488  RS-232  Sequential  Overlapped  Coupled

(Calibration Date command) return date associated with active calibration constants.

Parameter: See CAL\_STORE for more on significance of the date (there is none).

---

**CAL\_FACT**  IEEE-488  RS-232  Sequential  Overlapped  Coupled

(Calibration Fact command) Set the procedure “fault action” flag.

Parameter: (char) CONT to continue on faults or ABORT to abort on faults)

Example: CAL\_FACT ABORT (this is the default)

---

**CAL\_FACT?**  IEEE-488  RS-232  Sequential  Overlapped  Coupled

(Calibration Fact query) Get the procedure “fault action” flag.

Response: (char) CONT OR ABORT

Example: ABORT

---

**CAL\_FAULT?**  IEEE-488  RS-232  Sequential  Overlapped  Coupled

(Calibration Fault query) Get information about calibration error (if one occurred).

Response: 1. error number (use EXPLAIN? command to interpret)  
2. name of step where error occurred

---

**CAL\_INFO?**  IEEE-488  RS-232  Sequential  Overlapped  Coupled

(Calibration Information query) Return message or instructions associated with running step.

Response: (string) the message string

---

**CAL\_NEXT**  IEEE-488  RS-232  Sequential  Overlapped  Coupled

(Calibration Next command) Continue a calibration procedure if it is waiting.

Parameter: (Optional) Reference value (used if it's waiting for a reference)

If the reference value has no unit, the unit is assumed to be that returned by the CAL\_REF? command.

Example: CAL\_NEXT  
CAL\_NEXT 2.999987

---

**CAL\_REF?**  IEEE-488  RS-232  Sequential  Overlapped  Coupled

(Calibration Reference query) Return nominal value expected for reference entry.

Response: 1. the nominal value  
2. the accepted or implied unit

Example: 3.000000ef00,V

---

**CAL\_SHIFT?**  IEEE-488  RS-232  Sequential  Overlapped  Coupled

(Calibration Shift command) return a calibration shift.

Parameter: 1. (char) the shift type:  
ACTIVE compares ACTIVE with STORED  
STORED compares STORED with OLD  
DEFAULT compares ACTIVE with DEFAULT  
2. (char) the range name  
3. (float) the magnitude at which to calculate the shift  
4. (float) the frequency at which to calculate the shift  
Parameter 4 is required for all ranges even when it is ignored

Response: (float) the shift

---

**CAL\_START**  IEEE-488  RS-232  Sequential  Overlapped  Coupled

(Calibration Start command) Start a calibration procedure.

Parameter: 1. Procedure name (MAIN, SCOPE, ZERO, BOOST, or NOT): FACTORY  
MAIN is the procedure for the 5500 except for scope and 5725  
BOOST is the procedure for the 5725A  
SCOPE is the procedure for the 5500A scope cal option  
ZERO is the internal procedure to touch up zero offsets  
NOT aborts a procedure after the step is underway  
2. (Optional) name of the step at which to start.  
If this parameter is not provided, it starts at the beginning.

Example: CAL\_START MAIN  
CAL\_START MAIN, DVG3\_3

---

**CAL\_STATE?**  IEEE-488  RS-232  Sequential  Overlapped  Coupled

(Calibration State query) Return state of calibration.

Response: RON - running a calibration step

REF - waiting for a CAL\_NEXT with reference (measurement) value

INS - instruction available, waiting for a CAL\_NEXT

NOT - not in a calibration procedure (or at end of one)

---

**CAL\_STEP?**  IEEE-488  RS-232  Sequential  Overlapped  Coupled

(Calibration Step query) Return name of step currently running.

Response: (chart) The step name

Example: IDAC\_RATIO (running IDAC ratio calibration)

NOT (not running a calibration procedure now)

---

**CAL\_STORE**  IEEE-488  RS-232  Sequential  Overlapped  Coupled

(Calibration Store command) Store new calibration constants (CAL switch must be ENABLED).

Parameter: (optional) (int) Date to be stored with the constants

Other than requiring that it be a single integer between  $\pm 2,147,483,648$ ; the 5500 attaches no significance to the date stored. It is printed in any calibration reports and may be fetched using CAL\_DATE?

Example: CAL\_STORE 081294 - could mean August 12, 1994

---

**CAL\_STORE?**  IEEE-488  RS-232  Sequential  Overlapped  Coupled

(Calibration Store query) return whether a cal store is needed.

Response: 1 is yes, 0 if no

---

**CAL\_SW?**  IEEE-488  RS-232  Sequential  Overlapped  Coupled

(Calibration Switch query) Return the setting of the calibration enable switch.

Response: (integer) 1 for enable, 0 for normal

Example: 1

---

**CFREQ?**  IEEE-488  RS-232  Sequential  Overlapped  Coupled

(Capacitance Frequency query) Return the optimal frequency for stimulus when measuring or calibrating capacitance output.

Response: <value> of the optimal frequency

Example: CFREQ? returns 1.0E+2

Return 100 Hz as the optimal frequency for the selected capacitance output (1.0  $\mu$ F for this example). The return is 0 if not sourcing capacitance.

---

**\*CLS**  IEEE-488  RS-232  Sequential  Overlapped  Coupled

(Clear Status command) Clear the ESR, ISCR0, ISCR1, the error queue, and the RQS bit in the status byte. This command terminates pending operation complete commands (\*OPC or \*OPC?).

Parameter: (None)

Example: \*CLS

Clear the ESR, ISCR0, ISCR1, the error queue, and the RQS bit in the status byte.

---

**CUR\_POST**  IEEE-488  RS-232  Sequential  Overlapped  Coupled

(Current Post command) Select the active 5725A Amplifier or 5500A Calibrator front panel binding posts terminals for current output. This also applies to power outputs. The current post setting is retained until the 5500A Calibrator power is turned off or the 5500A Calibrator **RESET** button is pressed. If the current output can only be sourced by the 5725A Amplifier (for example, 2 A at 10 kHz), the parameter AUX will return an error "Value not available."

Parameters: AUX (selects the 5500A Calibrator AUX terminals)  
BOOST (selects the 5725A Amplifier terminals)

Example: CUR\_POST AUX

Select the 5500A Calibrator front panel AUX terminals for the output current.

---

**CUR\_POST?**  IEEE-488  RS-232  Sequential  Overlapped  Coupled

(Current Post query) Return the active front panel binding post terminals, 5725A Amplifier BOOST or 5500A Calibrator AUX, used for current output.

Responses: AUX (5500A Calibrator AUX terminals are selected)  
BOOST (5725A Amplifier BOOST terminals are selected)

Example: CUR\_POST? returns AUX

Return AUX when the 5500A Calibrator front panel AUX terminals are selected for output current.

---



**DC\_OFFSET**  IEEE-488  RS-232  Sequential  Overlapped  Coupled

(DC Voltage Offset command) Apply a DC offset to an AC output voltage (maximum six digits). This command applies only to single AC voltage outputs. If the selected offset is too large for the active ac voltage range, an error message is returned.

Parameter: <value> signed offset amplitude

Example: DC\_OFFSET +123.45 MV

Load a dc offset of +123.45 mV to the ac output signal.

---

**DC\_OFFSET?**  IEEE-488  RS-232  Sequential  Overlapped  Coupled

(DC Voltage Offset query) Return the value of the DC offset voltage.

Response: <value> signed offset amplitude

Example: DC\_OFFSET? returns +1.44E-03

Return 1.44 mV as the value of the applied dc offset. If +0.00000E+00 is returned, the dc offset is zero.

---

**DPF**  IEEE-488  RS-232  Sequential  Overlapped  Coupled

(Displacement Power Factor command) Set the displacement power factor (phase angle) between the 5500A Calibrator front panel terminals NORMAL and AUX (for sinewaves output only). The NORMAL terminal output is the phase reference. The phase offset is expressed as the cosine of the phase offset (0.000 to 1.000) and a LEAD (default) or LAG term, which determines whether the AUX output leads or lags the NORMAL output.

Parameters: <value>, LEAD  
<value>, LAG

Example: DPF .123, LEAD

Set the current output on the 5500A Calibrator AUX terminals to lead the voltage output on the NORMAL terminals by 82.93 degrees. (Cosine of 82.93 degrees is 0.123, nominal.)

---

**DPF?**  IEEE-488  RS-232  Sequential  Overlapped  Coupled

(Displacement Power Factor query) Return the displacement power factor (cosine of the phase angle) between the 5500A Calibrator front panel NORMAL and AUX terminals for sinewave outputs.

Responses: <value>, LEAD  
<value>, LAG

Example: DPF? returns 5.00E-01, LEAD

Return a leading power factor of .5 when the current output on the 5500A Calibrator AUX terminals leads the voltage output on the NORMAL terminals by 60 degrees. (Cosine of 60 degrees is 0.5.) The return is 0 if power factor does not apply to the output.

---

**DUTY**  IEEE-488  RS-232  Sequential  Overlapped  Coupled

(Duty Cycle command) Set the duty cycle of the squarewave output. The duty cycle is the percentage of time the waveform is in the positive part of its cycle (1.00 to 99.00 percent). Duty cycle applies only to single-output squarewaves.

Parameter: <value> of duty cycle with optional PCT (percent) unit

Example: DUTY 12.34 PCT

Set the squarewave duty cycle to 12.34%.

---

**DUTY?**  IEEE-488  RS-232  Sequential  Overlapped  Coupled

(Duty Cycle query) Return the value of the squarewave output duty cycle (1.00 to 99.00).

Response: <value> of duty cycle in percent

Example: DUTY? returns 1.234E+01

Return 12.34% for the value of the squarewave duty cycle.

---

**EARTH**  IEEE-488  RS-232  Sequential  Overlapped  Coupled

(Earth Ground command) Select whether or not the 5500A Calibrator front panel NORMAL LO terminal is tied to chassis (earth) ground. Once set, the 5500A Calibrator retains the earth setting until power off or reset.

Parameters: OPEN (disconnect front panel LO terminal from chassis ground)  
TIED (connect front panel LO terminal to chassis ground)

Example: EARTH TIED

Load TIED to tie the 5500A Calibrator front panel NORMAL LO terminal to earth (the front panel **EARTH** key annunciator is on).

---

**EARTH?**  IEEE-488  RS-232  Sequential  Overlapped  Coupled

(Earth Ground query) Return whether or not the 5500A Calibrator front panel NORMAL LO terminal is tied to chassis (earth) ground.

Responses: OPEN (front panel LO terminal disconnected from chassis ground)  
TIED (front panel LO terminal connected to chassis ground)

Example: EARTH? returns OPEN

Return OPEN when EARTH is not tied to the NORMAL LO terminal (the front panel **EARTH** key annunciator is off).

---

**EDIT**  IEEE-488  RS-232  Sequential  Overlapped  Coupled

(Edit command) Set the edit field to the primary, secondary or frequency field.

Parameters: PRI (edit the value in single output functions and the primary output value in dual output functions)  
 SEC (edit the secondary value in dual output functions)  
 FREQ (edit the frequency value in single ac output functions)  
 OFF (edit is off, which is the same as using the NEWREF command)

Example: EDIT FREQ

Load FREQ into the edit field to edit frequency.

---

**EDIT?**  IEEE-488  RS-232  Sequential  Overlapped  Coupled

(Edit query) Return the edit field setting.

Responses: PRI (value in single output functions, and the primary output value in dual output functions is in edit)  
 SEC (secondary value in dual output functions is in edit)  
 FREQ (frequency value in single ac output functions is in edit)  
 OFF (no value is in edit.)

Example: EDIT? returns OFF

Return OFF when no value is in edit.

---

**ERR?**  IEEE-488  RS-232  Sequential  Overlapped  Coupled

(Error query) Return the first error code contained in the 5500A Calibrator error queue, then removes that error code from the queue. Following the error code is an explanation of the error code, similar to but sometimes containing more specific information than the EXPLAIN? command. The explanation sent in response to this query can contain variables specific to a particular error event. See Appendix F for a list of error codes and error messages.

A zero value is returned when the error queue is empty. To read the entire contents of the error queue, repeat ERR? until the response 0, "No Error" is returned. For terminal users, the error queue return for ERR? is always 0, "No Error" because error messages are returned instead of queued.

Response: <value>, (error code value)  
 <string> (text string explaining the error)

Example: ERR? returns 0, "No Error"

Return 0, "No Error" when the error queue is empty.

---

**ERR\_UNIT**  IEEE-488  RS-232  Sequential  Overlapped  Coupled

(UUT Error Unit Thresh Hold command) Choose how UUT error is shown (this in nonvolatile).

Parameter: GT1000 UUT error is displayed in % above 1000 ppm, ppm below  
GT100 UUT error is displayed in % above 100 ppm, ppm below  
GT10 UUT error is displayed in % above 10 ppm, ppm below  
PPM UUT error is displayed in ppm always  
PCT UUT error is displayed in % always

---

**ERR\_UNIT?**  IEEE-488  RS-232  Sequential  Overlapped  Coupled

(UUT Error Unit Thresh Hold query) Returns presently selected values of ERR\_UNIT as one of the choices.

Responses: GT1000 UUT error is displayed in % above 1000 ppm, ppm below  
GT100 UUT error is displayed in % above 100 ppm, ppm below  
GT10 UUT error is displayed in % above 10 ppm, ppm below  
PPM UUT error is displayed in ppm always  
PCT UUT error is displayed in % always

---

**\*ESE**  IEEE-488  RS-232  Sequential  Overlapped  Coupled

(Event Status Enable command) Load a byte into the Event Status Enable (ESE) register. (See “Event Status Enable Register (ESE)” in Chapter 5)

Parameter: <value> (decimal equivalent of the ESE byte, 0 to 255)

Example: \*ESE 140

Load decimal 140 (binary 10001100) to enable bits 7 (PON), 3 (DDE) and 2 (QYE).

---

**\*ESE?**  IEEE-488  RS-232  Sequential  Overlapped  Coupled

(Event Status Enable query) Return the contents of the Event Status Enable (ESE) register. (See “Event Status Enable Register (ESE)” in Chapter 5)

Response: <value> (decimal equivalent of the ESE byte, 0 to 255)

Example: \*ESE? returns 133

Return decimal 133 (binary 10000101) when bits 7 (PON), 2 (QYE), 1 (OPC) are enabled.

---

**\*ESR?**  IEEE-488  RS-232  Sequential  Overlapped  Coupled

(Event Status Register query) Return the contents of the Event Status Register (ESR) and clears the register. (See Event Status Register (ESR)” in Chapter 5)

Response: <value> (decimal equivalent of the ESR byte, 0 to 255)

Example: \*ESR? returns 189

Return decimal 189 (binary 10111101) when bits 7 (PON), 5 (CME), 4 (EXE), 3 (DDE), 2 (QYE) and 0 (OPC) are enabled.

---

**EXPLAIN?**  IEEE-488  RS-232  Sequential  Overlapped  Coupled

(Explain Error query) Explain an error code. This command returns a string that explains the error code furnished as the parameter. The error code (same as the parameter) is originally obtained by sending the `FAULT?` query. (See the `ERR?` command, which returns both the error code and the explanation string.) See Appendix F for a list of error codes and error messages.

Parameter: <value> if the error code (an integer)

Response: <string> that explains the error code, with the parameter (if there is one) shown as a percent sign followed by d (integer parameter), f (floating point parameter), or s (string parameter)

Example: `EXPLAIN? 539` returns “Can’t change compensation now.”

Return the explanation of error 539: “Can’t change compensation now.”

---

**FAULT?**  IEEE-488  RS-232  Sequential  Overlapped  Coupled

(Fault query) Return the first error code contained in the 5500A Calibrator error queue, then remove that error from the queue. After obtaining the error code, use the `EXPLAIN?` command to view an explanation. A zero value is returned when the error queue is empty. To read the entire contents of the error queue, repeat `FAULT?` until the response is 0. (Only system errors appear in the error queue.)

Response: <value> of the error code

Example: `FAULT?` returns 539

Return the first error code in the error queue, number 539. To view an explanation of the error, enter the command `EXPLAIN? 539`.

---

**FORMAT**  IEEE-488  RS-232  Sequential  Overlapped  Coupled

(Format command) **Use with extreme care.** Restore the contents of the nonvolatile memory device to factory defaults. The memory holds calibration constants and setup parameters. You lose all calibration data permanently. The `CALIBRATION` switch on the rear panel of the 5500A Calibrator must be set in the `ENABLE` position or an execution error occurs, except for `FORMAT SETUP`.

Parameter: `ALL` (replaces the whole contents with factory defaults)  
`CAL` (replaces all cal constants with factory defaults)  
`SETUP` (replaces setup parameters with factory defaults)

Example: `FORMAT SETUP`

Replace the setup parameters with the default setup values (below). (The `FORMAT ALL` command is the same as `FORMAT CAL` and then `FORMAT SETUP`.) The `FORMAT SETUP` command also clears the `*PUD` string (see the `*PUD` command) and `SRQSTR` is set to “SRQ: %02x %02x %04x %04x” (see the `SRQSTR` command) and `SPLSTR` is set to “SPL: %02x %02x %04x %04x” (see the `SPLSTR` command).

Features			
Temperature Standard	its-90	Display Contrast*	level 7,7
Host Connection	gpib (IEEE-488)	Display Brightness*	level 1,0
GPIB Port Address	4	RTD Power Up Default Type	pt385
Serial Ports	8 bits, 1 stop bit, xon/xoff, parity none, 9600 baud, wait 30 sec.	Thermocouple Power Up Default Type	K
EOL (end of line)	CRLF	Source Preference	5500
EOF (end of file)	012,000	Current Limits	±11 A
Remote I/F	term	Voltage Limits	±1000 V
Remote commands (see Chapter 6)			
SRQSTR	SRQ: %02x %02x %04x %04x	*PUD string	cleared
* Output Display and Control Display, respectively. There are 8 levels: 0,1,2,3,4,5,6,7.			

**FUNC?**  IEEE-488  RS-232  Sequential  Overlapped  Coupled

(Function query) Return the present output, measurement, or calibration function. See the response below for output & measurement modes.

Responses:

DCV	(dc volts function)
ACV	(ac volts function)
DCI	(dc current function)
ACI	(ac current function)
RES	(ohms function)
CAP	(capacitance function)
RTD	(temperature with an rtd function)
TC_OUT	(temperature with a thermocouple function)
DC_POWER	(dc power function)
AC_POWER	(ac power function)
DCV_DCV	(dual dc volts function)
ACV_ACV	(dual ac volts function)
TC_MEAS	(measure temperature with a thermocouple)
SACV	(oscilloscope ac volts function)
SDCV	(oscilloscope dc volts function)
MARKER	(oscilloscope marker function)
LEVSINE	(oscilloscope leveled sine function)
EDGE	(oscilloscope edge function)

Example: FUNC? returns DCV\_DCV

Return DCV\_DCV when the 5500A Calibrator output function dual dc volts.

**HARMONIC**  IEEE-488  RS-232  Sequential  Overlapped  Coupled

(Harmonic command) Make the frequency of one output a multiple of another output for the ac voltage or ac power functions (sinewaves only). For example, in dual ac voltage, have the frequency of the voltage output on the 5500A Calibrator front panel NORMAL terminals at 60 Hz and the frequency of the voltage output on the AUX terminals at the 7th harmonic (420 Hz). The range for the harmonics is 1 to 50.

You can assign the fundamental frequency output on either the 5500A Calibrator NORMAL terminals or AUX terminals, or 5725A Amplifier BOOST terminals (if a 5725A Amplifier is connected) using the second PRI and SEC parameters. Omitting the second parameter leaves the fundamental and the harmonic locations unchanged.

Parameters: <value>, PRI (fundamental at 5500A NORMAL terminals)  
 <value>, SEC (fundamental at 5500A AUX terminals or 5725A Amplifier BOOST terminals, if a 5725A is connected)

Example: HARMONIC 5, PRI

Load the fundamental frequency at the primary (PRI) output (5500A Calibrator NORMAL terminals), and the 5th harmonic frequency is at the secondary output (5500A Calibrator AUX terminals, or 5725A Amplifier BOOST terminals, if a 5725A Amplifier is connected and enabled). For example, if the fundamental frequency output is 60 Hz, the harmonic frequency output is 300 Hz.

---

**HARMONIC?**  IEEE-488  RS-232  Sequential  Overlapped  Coupled

(Harmonic query) Return the present instrument harmonic characteristic and location of the fundamental output PRI (primary, the 5500A Calibrator NORMAL terminals) or SEC (secondary, the 5500A Calibrator AUX terminals, or 5725A BOOST terminals, if a 5725A Amplifier is connected and enabled).

Response: <value>, PRI (harmonic value, fundamental at primary output)  
 <value>, SEC (harmonic value, fundamental at secondary output)

Example: HARMONIC? returns 5, SEC

Return the 5th harmonic frequency is selected, and the fundamental is at the secondary output (5500A Calibrator AUX terminals, or 5725A Amplifier BOOST terminals, if a 5725A Amplifier is connected and enabled). Therefore, the harmonic frequency appears at the primary, or 5500A Calibrator NORMAL terminals.

---

**\*IDN?**  IEEE-488  RS-232  Sequential  Overlapped  Coupled

(Identification query) Return instrument model number, serial number, and firmware revision levels for the main, encoder, inguard, and 5725A Amplifier CPUs.

Response: <manufacturer>,  
<model>,  
<serial number>,  
<main firmware>+  
<encoder firmware>+  
<inguard firmware>+  
<5725A CPU> (\* if not attached)

Example: \*IDN? returns FLUKE,5500A,5248000,1.2+1.0+1.0+\*

Return Fluke manufacturer, model 5500A, serial number 5248000, main firmware version 1.2, encoder firmware 1.0, inguard firmware 1.0, and 5725A not attached.

---

**INCR**  IEEE-488  RS-232  Sequential  Overlapped  Coupled

(Increment command) Increment or decrement the output (as selected using the EDIT command, or defaults to the primary output) and enters error mode; the same as using the 5500A Calibrator output adjustment knob in local operation.

Parameters: <+ value> (increment value) (optional unit matching edit field)  
<- value> (decrement value)

Example: INCR +.00001 mV

Load the error mode and increment the selected edit field by .00001 mV.

---

**ISCE**  IEEE-488  RS-232  Sequential  Overlapped  Coupled

(Instrument Status Change Enable command) Load two bytes into the two 16-bit ISCE mask registers (ISCE1 and ISCE0). (See “Instrument Status Change Enable Registers” in Chapter 5 for more information.)

Parameter: <value> (decimal equivalent of the 16 bits, 0 to 32767)

Example: ISCE 4108

Load decimal 4108 (binary 0001000000001100) to enable bits 12 (SETTLED), 3 (IBOOST) and 2 (VBOOST). This is equivalent to sending the commands ISCE0 4108 and ISCE1 4108 (see below).

---



**ISCE?**  IEEE-488  RS-232  Sequential  Overlapped  Coupled

(Instrument Status Change Enable query) Return the two bytes from the two 16-bit ISCE mask registers (ISCE1 and ISCE0). (See “Instrument Status Change Enable Registers” in Chapter 5 for more information.)

Response: <value> (decimal equivalent of the 16 bits, 0 to 32767)

Example: ISCE? returns 4108

Return decimal 4108 (binary 0001000000001100) if bits 12 (SETTLED), 3 (IBOOST), and 2 (VBOOST) are set to 1.

---

**ISCE0**  IEEE-488  RS-232  Sequential  Overlapped  Coupled

(Instrument Status 0 to 1 Change Enable command) Load the two bytes into the 16-bit ISCE0 register. (See “Instrument Status Change Enable Registers” in Chapter 5 for more information.)

Parameter: <value> (decimal equivalent of the 16 bits, 0 to 32767)

Example: ISCE0 4108

Load decimal 4108 (binary 0001000000001100) to enable bits 12 (SETTLED), 3 (IBOOST) and 2 (VBOOST).

---

**ISCE0?**  IEEE-488  RS-232  Sequential  Overlapped  Coupled

(Instrument Status 0 to 1 Change Enable query) Return the two bytes from the 16-bit ISCE0 register. (See “Instrument Status Change Enable Registers” in Chapter 5 for more information.)

Response: <value> (decimal equivalent of the 16 bits, 0 to 32767)

Example: ISCE0? returns 4108

Return decimal 4108 (binary 0001000000001100) if bits 12 (SETTLED), 3 (IBOOST), and 2 (VBOOST) are set to 1.

---

**ISCE1**  IEEE-488  RS-232  Sequential  Overlapped  Coupled

(Instrument Status 1 to 0 Change Enable command) Load the two bytes into the 16-bit ISCE1 register. (See “Instrument Status Change Enable Registers” in Chapter 5 for more information.)

Parameter: <value> (decimal equivalent of the 16 bits, 0 to 32767)

Example: ISCE1 4108

Load decimal 4108 (binary 0001000000001100) to enable bits 12 (SETTLED), 3 (IBOOST) and 2 (VBOOST).

---

**ISCE1?**  IEEE-488  RS-232  Sequential  Overlapped  Coupled

(Instrument Status 1 to 0 Change Enable query) Return the two bytes from the 16-bit ISCE1 register. (See “Instrument Status Change Enable Registers” in Chapter 5 for more information.)

Response: <value> (decimal equivalent of the 16 bits, 0 to 32767)

Example: ISCE1? returns 4108

Return decimal 4108 (binary 0001000000001100) if bits 12 (SETTLED), 3 (IBOOST), and 2 (VBOOST) are set to 1.

---

**ISCR?**  IEEE-488  RS-232  Sequential  Overlapped  Coupled

(Instrument Status Change Register query) Returns and clears the contents of the Instrument Status 0 to 1 Change Register (ISCR0) and Instrument Status 1 to 0 Change Register (ISCR1). (See “Instrument Status Change Register” in Chapter 5 for more information.)

Response: <value> (decimal equivalent of the 16 bits, 0 to 32767)

Example: ISCR? returns 4108

Return decimal 4108 (binary 0001000000001100) if bits 12 (SETTLED) and 3 (IBOOST) are enabled (set to 1) in the Instrument Status 0 to 1 Change Register and bits 12 (SETTLED) and 2 (VBOOST) are enabled (set to 1) in the Instrument Status 1 to 0 Change Register.

---

**ISCR0?**  IEEE-488  RS-232  Sequential  Overlapped  Coupled

(Instrument Status 0 to 1 Change Register query) Returns and clears the contents of the Instrument Status 0 to 1 Change Register.

Response: <value> (decimal equivalent of the 16 bits, 0 to 32767)

Example: ISCR0? returns 4108

Return decimal 4108 (binary 0001000000001100) if bits 12 (SETTLED), 3 (IBOOST), and 2 (VBOOST) are set to 1.

---

**ISCR1?**  IEEE-488  RS-232  Sequential  Overlapped  Coupled

(Instrument Status 1 to 0 Change Register query) Returns and clears the contents of the Instrument Status 1 to 0 Change Register.

Response: <value> (decimal equivalent of the 16 bits, 0 to 32767)

Example: ISCR1? returns 4108

Return decimal 4108 (binary 0001000000001100) if bits 12 (SETTLED), 3 (IBOOST), and 2 (VBOOST) are set to 1.

---

**ISR?**  IEEE-488  RS-232  Sequential  Overlapped  Coupled

(Instrument Status Register query) Returns contents of the Instrument Status Register.

Response: <value> (decimal equivalent of the 16 bits, 0 to 32767)

Example: `ISR?` returns 4108

Return decimal 4108 if bits 12 (SETTLED), 3 (IBOOST), and 2 (VBOOST) are set to 1.

---

**LIMIT**  IEEE-488  RS-232  Sequential  Overlapped  Coupled

(Limit command) Set the maximum permissible output magnitude, negative and positive, for voltage and current, which is saved in the 5500A non-volatile memory. (While saving configuration data in the non-volatile memory, a period of about 2 seconds, the 5500A does not respond to remote commands.) Both negative and positive values must be entered. Once set, the 5500A Calibrator retains the limit settings until either another limit is entered, or the `FORMAT SETUP` command resets the limits (and all other defaults) to the factory settings ( $\pm 1000$  V,  $\pm 11$  A). See the `FORMAT` command.

The magnitude of the limit has the following effect on different waveforms:

dc	magnitude of limit
ac (sinewave)	magnitude of limit (rms)
ac (non-sinewave)	magnitude of limit x 3 (peak-to-peak)
ac (with dc offset)	magnitude of limit x 2.4 (absolute peak) (volts only)

Parameters: <positive value> , <negative value>

Example: `LIMIT 100V, -100V`

Limit the voltage output to  $\pm 100$  V dc, 100 V ac rms, 300 V peak-to-peak, 240 V peak.

Example: `LIMIT 1A, -1A`

Limit the current output to  $\pm 1$  A dc, 1 A ac rms, 3 A peak-to-peak.

---

**LIMIT?**  IEEE-488  RS-232  Sequential  Overlapped  Coupled

(Limit query) Returns the programmed output magnitude limits for voltage and current.

Response: <positive value voltage> , <negative value voltage> ,  
 <positive value current> , <negative value current>

Example: `LIMIT?` returns 1000.0000 , -1000.0000 , 11.0000 - 11.0000

Return the present value of the voltage and current limits (reset values shown).

---

**LOCAL**  IEEE-488  RS-232  Sequential  Overlapped  Coupled

(Local command) Puts the 5500A Calibrator into the local state, clearing the remote state (see the REMOTE command) and front panel lockout (see the LOCKOUT command). This command duplicates the IEEE-488 GTL (Go To Local) message.

Parameter: (None)

Example: LOCAL

Set the instrument into the local state, clearing the remote state and front panel lockout (if enable).

---

**LOCKOUT**  IEEE-488  RS-232  Sequential  Overlapped  Coupled

(Lockout command) Puts the 5500A Calibrator into the lockout state when in remote control (see the REMOTE command). This means no local operation at the front panel is allowed during remote control. To clear the lockout condition, use the LOCAL command. This command duplicates the IEEE-488 LLO (Local Lockout) message.

Parameter: (None)

Example: LOCKOUT

Set the instrument into the front panel lockout state. The front panels controls cannot be used.

---

**LOWS**  IEEE-488  RS-232  Sequential  Overlapped  Coupled

(Low Potential Output Terminals command) Select whether or not the 5500A Calibrator front panel NORMAL LO terminal and AUX LO terminal are internally tied together (default) or are open. This feature is used for ac power, dc power, dual dc volts and dual ac volts outputs. Once set, the 5500A Calibrator retains the LO setting until power off or reset.

Parameter: OPEN (disconnect NORMAL LO and AUX LO terminals)  
TIED (connect NORMAL LO and AUX LO terminals)

Example: LOWS TIED

Tie the front panel NORMAL LO and AUX LO terminals together.

---

**LOWS?**  IEEE-488  RS-232  Sequential  Overlapped  Coupled

(Low Potential Output Terminals query) Return whether or not the 5500A Calibrator front panel NORMAL LO terminal and AUX LO terminal are internally tied together (default) or are open.

Response: OPEN (disconnected NORMAL LO and AUX LO terminals)  
TIED (connected NORMAL LO and AUX LO terminals)

Example: LOWS? returns OPEN

Return OPEN when the 5500A Calibrator front panel NORMAL LO and AUX LO terminals are not tied together.

---

**MULT**  IEEE-488  RS-232  Sequential  Overlapped  Coupled

(Multiply command) Multiply the reference magnitude (as selected with the `EDIT` command or default to the primary output). The reference magnitude is the present reference in either direct mode or in error mode.

Parameter: <value> (multiplier expressed as a floating point number)

Example: `MULT 2.5`

Multiply the existing reference by 2.5, creating a new reference. For example, an existing reference of 1 V is multiplied to 2.5 V.

---

**NEWREF**  IEEE-488  RS-232  Sequential  Overlapped  Coupled

(New Reference command) Set the new reference to the present 5500A Calibrator output value and exit the error mode (if selected). For example, you might edit the 5500A Calibrator output using the `EDIT` and `INCR` commands, and then use the `NEWREF` command to establish a new reference point and exit the error mode. This is the same as pressing the 5500A Calibrator front panel  key.

Parameter: (None)

Example: `NEWREF`

Set the reference value to the current 550A Calibrator output value.

---

**OLDREF**  IEEE-488  RS-232  Sequential  Overlapped  Coupled

(Old Reference command) Set the 5500A Calibrator output to the reference value and exit the error mode (if selected). If editing the output using the `EDIT` and `INCR` commands and you want to return to the reference value, use the `OLDREF` command. If editing the output and you want to make the edited value the new reference, use the `NEWREF` command.

Parameter: (None)

Example: `OLDREF`

Set the output to the existing reference value, clearing editing changes.

---

**ONTIME?**  IEEE-488  RS-232  Sequential  Overlapped  Coupled

(Calibrator On Time query) Return the time since the 5500A Calibrator was most recently powered up.

Response: <days>, <hours> (24-hour clock)

Example: `ONTIME?` returns `5 DAYS, 19:57:45`

Return the time since the 5500A Calibrator was last powered up: 5 days, 19 hours, 57 minutes and 45 seconds.

---

**\*OPC**  IEEE-488  RS-232  Sequential  Overlapped  Coupled

(Operations Complete command) Set bit 0 (OPC) of the Event Status Register to 1 when all pending device operations are complete. Also see the \*ESR? command.

Parameter: (None)

Example: \*OPC

Set bit 0 of the Event Status Register to 1 when all pending device operations are done.

---

**\*OPC?**  IEEE-488  RS-232  Sequential  Overlapped  Coupled

(Operations Complete query) Return a 1 after all pending operations are complete. This command causes program execution to pause until operations are complete. (See \*WAI.)

Response: 1 (all operations are complete)

Example: \*OPC? returns 1

Return 1 when all pending operations are complete.

---

**OPER**  IEEE-488  RS-232  Sequential  Overlapped  Coupled

(Operate command) Activate the 5500A Calibrator output if it is in standby. This is the same as pressing the 5500A Calibrator front panel **OPR** key. If there are errors in the error queue, the OPER command is inhibited for outputs 33V and over. (Also see the ERR? command and STBY command.)

Parameter: (None)

Example: OPER

Connect the selected output to the 5500A Calibrator front panel terminals. Also lights the annunciator in the **OPR** key.

---

**OPER?**  IEEE-488  RS-232  Sequential  Overlapped  Coupled

(Operate query) Return the operate/standby setting.

Response: 1 (Operate)  
0 (Standby)

Example: OPER? returns 1

Return 1 when the 5500A Calibrator is in operate.

---

**\*OPT?**  IEEE-488  RS-232  Sequential  Overlapped  Coupled

Returns a list of the installed hardware and software options, including any 5725A Amplifiers that are attached.

Responses: <option string>, <option string>, ... (options list, separated by commas)  
0 (no options are installed)

Example: \*OPT? returns 5725A, 5500A-SC

Return 5725A, 5500A-SC when the 5725A Amplifier option is attached and the Oscilloscope Calibration Option is installed.

---

**OUT**  IEEE-488  RS-232  Sequential  Overlapped  Coupled

Sets the output of the 5500A Calibrator and establishes a new reference point for the error mode. If only one amplitude is supplied, the 5500A Calibrator sources a single output. If two amplitudes are supplied, the 5500A Calibrator sources two outputs. The second amplitude will be sourced at the AUX terminals for dual voltage outputs. If the frequency is not supplied, the 5500A Calibrator will use the frequency that is presently in use.

To source or measure a temperature, select the desired sensor and sensor parameters first. (See the `TSSENS_TYPE`, `RTD_*`, and `TC_*` commands.)

To source a signal using the 5500A-SC option, refer to the `SCOPE` command in Chapter 8.

If you change the frequency of an ac function and the harmonic output is not explicitly set at the same time with the `HARMONIC` command, the harmonic will be set to 1.

Use multipliers e.g., k, M,  $\mu$  with the `OUT` command, as desired.

Parameters: <value> V	Volts dc or update volts ac
<value> DBM	Volts ac dBm update
<value> V, <value> Hz	Volts ac or volts dc with 0 Hz
<value> DBM, <value> Hz	Volts ac in dBm
<value> A	Current dc or update current ac
<value> A, <value> Hz	Current ac
<value> OHM	Resistance
<value> F	Capacitance
<value> CEL	Temperature (Celsius)
<value> FAR	Temperature (Fahrenheit)
<value> HZ	Update frequency
<value> V, <value> A	Power dc or update power ac
<value> DBM, <value> A	Power ac in dBm update
<value> V, <value> A, <value> HZ	Power ac
<value> DBM, <value> A, <value> HZ	Power ac in dBm
<value> V, <value> V	Dual volts dc or update dual ac
<value> DBM, <value> DBM	Dual volts ac in dBm update
<value> V, <value> V, <value> HZ	Dual volts ac in volts
<value> DBM, <value> DBM, <value> HZ	Dual volts ac in dBm
<value>	For single output, changes amplitude keeping unit and frequency the same.

Examples: OUT 15.2 V	(volts; 15.2 V @ same frequency)
OUT 20 DBM	(volts; 20 dBm @ same frequency)
OUT 10 V, 60 Hz	(volts ac; 10 V @ 60 Hz)
OUT 10 DBM, 50 HZ	(volts ac; 10 dBm @ 50 Hz)
OUT 1.2 MA	(current; 1.2 mA @ same frequency)
OUT 1 A, 400 HZ	(current ac; 1 A @ 400 Hz)
OUT 1 KOHM	(ohms; 1 k $\Omega$ )
OUT 1 UF	(capacitance; 1 $\mu$ F)
OUT 100 CEL	(temperature; 100 $^{\circ}$ C)
OUT -32 FAR	(temperature; -32 $^{\circ}$ F)
OUT 60 HZ	(frequency update; 60 Hz)

OUT 10 V, 1 A (power; 10 watts @ same frequency)  
OUT 15 DBM, .5 A (power; 7.5 watts @ same frequency)  
OUT 1 V, 1 A, 60 HZ (power ac; 1 watts @ 60 Hz)  
OUT 5 DBM, 1 A, 50 HZ (power ac; 5 watts @ 50 Hz)  
OUT 1 V, 2 V (dual volts; 1 V, 2 V @ same freq.)  
OUT 8 DBM, 12 DBM (dual volts ac; 8/12 dBm @ same freq.)  
OUT 10 MV, 20 MV, 60 HZ (dual volts; .01 V, .02 V @ 60 Hz)  
OUT 6 DBM, 8 DBM, 50 HZ (dual volts; 6 & 8 dBm @ 50 Hz)

Each example shows a value and unit, e.g., -15.2 V. If a value is entered without a unit, the value of the existing output is changed, when logically allowed.

---

**OUT?**  IEEE-488  RS-232  Sequential  Overlapped  Coupled

Returns the output amplitudes and frequency of the 5500A Calibrator. Multipliers (e.g., K or M) are not used in the response.

Parameters: V (optional for ac voltage and TC modes)  
DBM (optional for ac voltage modes)  
CEL (optional for RTD and TC modes, Celsius)  
FAR (optional for RTD and TC modes, Fahrenheit)  
OHM (optional for RTD modes, ohms)

Response: <primary amplitude value>,<primary units>,  
<secondary amplitude value>,<secondary units>,  
<fundamental frequency value>

Examples: OUT? returns -1.520000E+01,V,0E+00,0,0.00E+00  
OUT? returns 1.88300E-01,A,0E+00,0,4.420E+02  
OUT? returns 1.23000E+00,V,2.34000E+00,V,6.000E+01  
OUT? DBM, DBM returns 4.02E+00,DBM,9.60E+00,DBM,6.000E+01  
OUT? DBM, V returns 4.02E+00,DBM,2.34000E+00,V,6.000E+01  
OUT? returns 1.92400E+06,OHM,0E+00,0,0.00E+00  
OUT? returns 1.52000E+01,V,1.88300E-01,A,4.420E+02  
OUT? DBM returns 2.586E+01,DBM,1.88300E-01,A,4.420E+02  
OUT? returns 1.0430E+02,CEL,0E+00,0,0.00E+00  
OUT? FAR returns 2.19740000E+02,FAR,0E+00,0,0.00E+00  
OUT? V returns 4.2740E-03,V,0E+00,0,0.00E+00  
OUT? OHM returns 1.40135E+02,OHM,0E+00,0,0.00E+00

The respective values for the above examples are:

-15.2 V  
188.3 mA, 442 Hz  
1.23 V, 2.34 V, 60 Hz  
4.02 dBm, 9.6 dBm, 60 Hz (4.02 dBm=1.23 V; 9.6 dBm = 2.34 V)  
4.02 dBm, 2.34 V, 60 Hz (4.02 dBm=1.23 V)  
1.924 MΩ  
15.2 V, 188.3 mA, 442 Hz  
25.86 dBm, 188.3 mA, 442 Hz (25.86 dBm = 15.2 V)  
104.3 °C



219.74 °F (same value as 104.3 °C, in Fahrenheit)  
 4.274 mV (same value as 104.3 °C for a K-type thermocouple, in volts)  
 140.135 Ω (same value as 104.3 °C for a pt385 RTD, in ohms)

The primary and secondary units are: V, DBM, A, OHM, F, CEL, FAR. The units for the <frequency value> is always assumed to be Hz.

---

**OUT\_ERR?**  IEEE-488  RS-232  Sequential  Overlapped  Coupled

(Output Error query) Return the UUT error and units computed by the 5500A Calibrator after shifting the output with the INCR command. The return units are PPM (parts per million), PCT (percent), DB (decibels) or 0 if there is no error. The UUT error is not computed when editing frequency.

Response: <value of error>, <units>

Example: OUT\_ERR? returns -1.00000E+01, PCT

Return -10% when the UUT is reading low by 10%.

---

**PHASE**  IEEE-488  RS-232  Sequential  Overlapped  Coupled

(Phase Difference command) Set a phase difference between the 5500A Calibrator front panel NORMAL and AUX terminals for ac power and ac dual voltage outputs. The NORMAL terminal output is the phase reference. The set range is 0.00 to ±180.00 degrees, with + for a leading phase difference and - for a lagging phase difference.

Parameter: <phase value> DEG (DEG, for degree, is optional)

Example: PHASE -60 DEG

Set the phase difference so the frequency output at the AUX terminals lags the frequency output at the NORMAL terminals by 60 degrees.

---

**PHASE?**  IEEE-488  RS-232  Sequential  Overlapped  Coupled

(Phase Difference query) Return the phase difference between the 5500A Calibrator front panel NORMAL and AUX terminals for ac power and ac dual voltage outputs.

Response: <phase value>

Example: PHASE? returns -6.000E+01

Return -60 when the frequency output at the AUX terminals is lagging the frequency output at the NORMAL terminals by 60 degrees.

---

**POWER?**  IEEE-488  RS-232  Sequential  Overlapped  Coupled

(Calculate Power Output query) Return the equivalent real power for ac and dc power outputs, based on the voltage and current settings, and power factor (ac only). If the output is not ac or dc power, the return is 0E+00 (zero) watts.

Response: <value> (in watts)

Example: POWER? returns 1.00000E+01

Return 10 when the output voltage is 10 V dc and output current 1 A dc, for 10 watts real power.

Example: POWER? returns 1.00000E+01

Return 10 when the output voltage is 10 V ac and output current 2 A ac and power factor is .5, for 10 watts real power.

---

### PR-PRT X IEEE X RS-232

Description: Prints a self-calibration report out the selection serial port.

- Parameters:
1. Type of report to print: **STORED, ACTIVE, OR CONSTS**
  2. Format of report: **PRINT** (designed to be read),  
**SPREAD** (designed to be loaded into a spreadsheet)
  3. Calibration interval to be used for instrument specification in the report: **I90D** (90 day spec), **I1Y** (1 year spec)
  4. Serial port through which to print: **HOST,UUT**

Example: PR\_PRT STORED, PRINT, 190D, HOST

---

**\*PUD**  IEEE-488  RS-232  Sequential  Overlapped  Coupled

(Protected User Data command) Store a string of 64 characters (maximum), which is saved in the 5500A non-volatile memory. (While saving configuration data in the non-volatile memory, a period of about 2 seconds, the 5500A does not respond to remote commands.) This command works only when the CALIBRATION switch on the rear panel of the 5500A Calibrator is in the ENABLE position. Include a line feed (RS-232) character to terminate the block data or End or Identify (EOI) command (IEEE-488).

Parameter: #2<nn><nn characters string> (definite length)  
#0<character string> (indefinite length)  
"<character string>" (character string)

Example: \*PUD #0CAL LAB NUMBER 1

Store the string CAL LAB NUMBER 1 in the protected user data area using the indefinite length format.

Example: \*PUD #216CAL LAB NUMBER 1

Store the string CAL LAB NUMBER 1 in the protected user data area using the definite length format, where #2 means two digits follow which represent the number of text characters nn in CAL LAB NUMBER 1 (including spaces=16).

Example: \*PUD "CAL LAB NUMBER 1"

Store the string CAL LAB NUMBER 1 in the protected user data area using the character string format.

---

**\*PUD?**  IEEE-488  RS-232  Sequential  Overlapped  Coupled

Returns the contents of the \*PUD (Protected User Data) memory in definite length format.

Response: #2nn<nn characters>

Example: \*PUD? returns #216CAL LAB NUMBER 1

Return #2 then 16 then 16 characters of text (including spaces) stored in the nonvolatile memory.

---

**RANGE?**  IEEE-488  RS-232  Sequential  Overlapped  Coupled

(Range query) Return the present output ranges. Both the primary output and secondary outputs are returned. If there is no secondary output, 0 is returned. Dual outputs are noted with P for primary output (front panel NORMAL terminals) and S for secondary output (front panel AUX terminals).

Response: <primary output> , <secondary output>

Examples:	DC330MV , 0	(dc volts 330 mV range)
	DC33MA_A , 0	(dc current 33 mA range)
	AC3_3V , 0	(ac volts 3.3 V range)
	AC330MA_A , 0	(ac current 330 mA range)
	R110OHM , 0	(ohms 110 Ω range)
	C1_1UF , 0	(capacitance 1.1 μF range)
	TCSRC , 0	(temperature thermocouple source)
	RTD_330 , 0	(temperature RTD 330 Ω range)
	DC3_3V_P , DC2_2A_AS	(dc power 3.3 V, 2.2 A ranges)
	AC330V_P , AC11A_AS	(ac power 330 V, 11 A ranges)
	DC330MV_P , DC3_3V_S	(dual dc volts 330 mV, 3.3 V ranges)
	AC330V_P , AC3_3V_S	(dual ac volts 330 V, 3.3 V ranges)

Return the symbolic name of the single or first output, and return the symbolic name of the second output (0 if there is no second output).

---

**RANGELCK**  IEEE-488  RS-232  Sequential  Overlapped  Coupled

(Range Lock command) Locks in the present range, or selects auto ranging for dc voltage and dc current single outputs. The range automatically unlocks if the output function changes, for example from dc volts to dc current. When RANGELCK is on, this is equivalent to the softkey range lock showing locked. When RANGELCK is off, this is equivalent to the softkey range lock showing auto.

Parameter: ON (Locks the dc volts or dc current range)  
OFF (Unlocks the dc volts or dc current range for autoranging)

Example: RANGELCK OFF

Set the range lock off to allow autoranging for dc volts or dc current.

---

**RANGELCK?**  IEEE-488  RS-232  Sequential  Overlapped  Coupled

(Range Lock query) Return whether or not the preset dc volts or dc current single output range is locked.

Response: ON (range is locked and autoranging is not allowed)  
OFF (range is not locked and autoranging is allowed)

Example: RANGELCK? returns OFF

Return OFF when the range for dc volts or dc current is not locked (autoranging enabled).

---

**REFOUT?**  IEEE-488  RS-232  Sequential  Overlapped  Coupled

(Reference Output query) Return the present value of the reference when editing the output (error mode). If not editing the output using the INCR command, the return is 0 (0E+00). The reference value is set with the OUT, NEWREF or MULT commands. To determine which quantity is being edited, use the EDIT? and OUT? commands.

Response: <reference value>

Example: REFOUT? returns 0E+00

Return 0 when the output is not being edited.

Example: REFOUT? returns 2.500000E-01

Return .250 when the output is being edited and the reference is, for example, 250 mV.

---

**REMOTE**  IEEE-488  RS-232  Sequential  Overlapped  Coupled

(Remote command) Place the 5500A Calibrator into the remote state. This command duplicates the IEEE-488 REN (Remote Enable) message. When in the remote state, the Control Display shows the softkey "REMOTE CONTROL Go to Local." Pressing this softkey returns the 5500A Calibrator to local operation. If the front panel is locked out, the Control Display shows the softkey "REMOTE CONTROL LOCAL LOCK OUT." (See the LOCKOUT command.) To unlock the front panel, use the LOCAL command, or cycle the 5500A Calibrator power switch.

Parameter: (None)

Example: REMOTE

Place the 5500A Calibrator in the remote state and display this state on the front panel Control Display with a softkey REMOTE CONTROL.

---

**RPT\_STR**  IEEE-488  RS-232  Sequential  Overlapped  Coupled

Loads the user report string. The user report string can be read on the Control Display in local operation, and appears on calibration reports. The CALIBRATION switch must be set to ENABLE. (Sequential command.)

Parameter: String of up to 40 characters

---

**RPT\_STR?**  IEEE-488  RS-232  Sequential  Overlapped  Coupled

Returns the user report string. The user report string can be read on the Control Display in local operation, and appears on calibration reports. (Sequential command.)

Parameter: None

Response: (String) Up to 40 characters

**\*RST**  IEEE-488  RS-232  Sequential  Overlapped  Coupled

(Reset Instrument command) Reset the 5500A Calibrator to the power-up state. \*RST holds off execution of subsequent commands until the reset operation is complete. This command is the same as pressing the front panel **RESET** key.

A reset action evokes the following commands and values:

Command	Value	Command	Value
STBY	(No output)	CUR_POST	AUX
OUT	0V, 0HZ	EARTH	OPEN
DC_OFFSET	0V	LOWS	TIED
DUTY	50PCT	RTD_TYPE	<RTD_TYPE_D value>
HARMONIC	1, PRI	TC_OTCD	ON
PHASE	0DEG	TC_REF	INT
RANGELCK	OFF	TC_TYPE	<TC_TYPE_D value>
WAVE	NONE, NONE	TC_OFFSET	0 CEL
ZCOMP	OFF	TSENS_TYPE	TC
SCOPE	OFF	OUT_IMP	Z1M
TRIG	OFF		

Changes made to the setup menus that are not saved in memory are discarded on reset.

Response: (None)

Example: \*RST

Place the 5500A Calibrator in a reset condition, evoking the commands and values shown above.

**RTD\_TYPE**  IEEE-488  RS-232  Sequential  Overlapped  Coupled

(Resistance Temperature Detector Type command) Set the Resistance Temperature Detector (RTD) sensor type: pt385 (curve  $\alpha=0.00385$  ohms/ohm/°C) (default), pt3926 (curve  $\alpha=0.003926$  ohms/ohm/°C), or ni120 (empirical Curve for 120 Ohm Nickel RTD).

Before using RTD\_TYPE, select RTD using the TSENS\_TYPE command. After using RTD\_TYPE, select the output temperature using the OUT command. Changes in temperature sensors changes the output to 0 °C. Once set, the 5500A retains the RTD type until power off or reset.

Parameters: PT385 (100-ohm RTD, curve  $\alpha=0.00385$  ohms/ohm/°C)  
 PT3926 (100-ohm RTD, curve  $\alpha=0.003926$  ohms/ohm/°C)  
 NI120 (120-ohm RTD, empirical curve)

Example: RTD\_TYPE PT3926

Set the RTD type to a 100-ohm type, using the pt3926 curve ( $\alpha=0.003926$  ohms/ohm/°C). The resistance of 100 ohms refers to the ice point characteristic, (the resistance of the RTD at 0 °C (32 °F)).

**RTD\_TYPE?**  IEEE-488  RS-232  Sequential  Overlapped  Coupled

(Resistance Temperature Detector Type query) Return the Resistance Temperature Detector (RTD) type used for RTD temperature simulations.

Responses: PT385 (100-ohm RTD, curve  $\alpha=0.00385$  ohms/ohm/°C)  
PT3926 (100-ohm RTD, curve  $\alpha=0.003926$  ohms/ohm/°C)  
NI120 (120-ohm RTD, empirical Curve)

Example: RTD\_TYPE? returns PT3926

Return PT3926 when a 100-ohm RTD with curve  $\alpha=0.003926$  ohms/ohm/°C is set as the RTD type.

---

**RTD\_TYPE\_D**  IEEE-488  RS-232  Sequential  Overlapped  Coupled

(Resistance Temperature Detector Type Default command) Set the default Resistance Temperature Detector (RTD) at power on and reset, which is saved in the 5500A non-volatile memory. (While saving configuration data in the non-volatile memory, a period of about 2 seconds, the 5500A does not respond to remote commands.)

Parameters: PT385 (100-ohm RTD, curve  $\alpha=0.00385$  ohms/ohm/°C)  
PT3926 (100-ohm RTD, curve  $\alpha=0.003926$  ohms/ohm/°C)  
NI120 (120-ohm RTD, empirical Curve)

Example: RTD\_TYPE\_D PT3926

Set the RTD default type to a 100-ohm RTD with curve  $\alpha=0.003926$  ohms/ohm/°C.

---

**RTD\_TYPE\_D?**  IEEE-488  RS-232  Sequential  Overlapped  Coupled

(Resistance Temperature Detector Type Default query) Return the default Resistance Temperature Detector (RTD) used at power on and reset.

Responses: PT385 (100-ohm RTD, curve  $\alpha=0.00385$  ohms/ohm/°C)  
PT3926 (100-ohm RTD, curve  $\alpha=0.003926$  ohms/ohm/°C)  
NI120 (120-ohm RTD, empirical Curve)

Example: RTD\_TYPE\_D? returns PT3926

Return PT3926 when the RTD default type is a 100-ohm RTD with curve  $\alpha=0.003926$  ohms/ohm/°C.

---

**SP\_SET**    IEEE-488    RS-232    Sequential    Overlapped    Coupled

(Host Serial Port Set command) Set the RS-232-C settings for the 5500A Calibrator rear panel SERIAL 1 FROM HOST serial port, which is saved in the 5500A non-volatile memory. (While saving configuration data in the non-volatile memory, a period of about 2 seconds, the 5500A does not respond to remote commands.) (To set the parameters for the rear panel SERIAL 2 TO UUT serial port, see the UUT\_SET command.) The factory default values are shown below in **bold** type. (To return to the factory defaults, see the FORMAT SETUP command.)

The interface selection sets the command response, with command echo back for commands and error messages with TERM (terminal) or no echo back with COMP (computer).

Parameters:   <baud rate value>,      300, 600, 1200, 2400, 4800, **9600**  
                   <interface>,                **TERM** (terminal), COMP (computer)  
                   <flow control>,        **XON** (xon/xoff), NOSTALL (none), RTS (rts/cts)  
                   <number data bits>,      DBIT7 (7 bits) or **DBIT8** (8 bits)  
                   <number stop bits>,    **SBIT1** (1 bit) or SBIT2 (2 bits)  
                   <parity>,                **PNONE** (none), PODD (odd),PEVEN (even)  
                   <end of line char.>    CR (carriage return), LF (line feed),  
    **CRLF** (carriage return/line feed)

Example:      SP\_SET 9600 ,TERM ,XON ,DBIT8 ,SBIT1 ,PNONE ,CRLF

Set the parameters for the rear panel SERIAL 1 FROM HOST serial port to the factory default values.

**SP\_SET?**    IEEE-488    RS-232    Sequential    Overlapped    Coupled

(Host Serial Port Set query) Return the RS-232-C settings for the 5500A Calibrator rear panel SERIAL 1 FROM HOST serial port. (To return the parameters for the rear panel SERIAL 2 TO UUT serial port, see the UUT\_SET? command.) The factory default values are shown below in **bold** type. (To return to the factory defaults, see the FORMAT SETUP command.)

Responses:   <baud rate value>,      300, 600, 1200, 2400, 4800, **9600**  
                   <interface>,                **TERM** (terminal), COMP (computer)  
                   <flow control>,        **XON** (xon/xoff), NOSTALL (none), RTS (rts/cts)  
                   <number data bits>,      DBIT7 (7 bits) or **DBIT8** (8 bits)  
                   <number stop bits>,    **SBIT1** (1 bit) or SBIT2 (2 bits)  
                   <parity>,                **PNONE** (none), PODD (odd),PEVEN (even)  
                   <end of line char.>    CR (carriage return), LF (line feed),  
    **CRLF** (carriage return/line feed)

Example:      SP\_SET? returns 9600 ,TERM ,XON ,DBIT8 ,SBIT1 ,PNONE ,CRLF

Return the parameters for the rear panel SERIAL 1 FROM HOST serial port, as shown, when set to the factory default values.

**SPLSTR**  IEEE-488  RS-232  Sequential  Overlapped  Coupled

(Serial Poll String command) Set the Serial Poll String (string up to 40 characters) which is saved in the 5500A non-volatile memory. (While saving configuration data in the non-volatile memory, a period of about 2 seconds, the 5500A does not respond to remote commands.) The SPLSTR is sent to the host over the serial interface when a ^P (<cntl> P) character is sent. The default format is:

```
SPL: %02x %02x %04x %04x
```

where the term %02x (8 bits) means print the value in hexadecimal with exactly 2 hex digits, and %04x (16 bits) means print the value in hexadecimal with exactly 4 hex digits. The string representations are:

```
SPL: (STB) (ESR) (ISCR0) (ISCR1)
```

See the commands, respectively, \*STB?, \*ESR?, ISCR0?, and ISCR1?. A typical string in the default format sent to the host is: SPL: 44 00 0000 1000. This command is for format. For values instead of format, enter a ^P (<cntl> p) character. Also see the SRQSTR command.

Parameter: "<string>\n" (\n represents the NEWLINE character, hex 0A)

Example: SPLSTR "SPL: %02x %02x %04x %04x\n"

Set the SPLSTR to the default values SPL: %02x %02x %04x %04x\n.

---

**SPLSTR?**  IEEE-488  RS-232  Sequential  Overlapped  Coupled

(Serial Poll Response String query) Return the string programmed for Serial Poll response. For values, enter a ^P (<cntl> p) character. Also see the SRQSTR command.

Response: <string>

Example: SRQSTR returns SRQ: %02x %02x %04x %04x\n

Return the SPLSTR string format (default settings in this example).

---

**SRC\_PREF**  IEEE-488  RS-232  Sequential  Overlapped  Coupled

(Source Preference command) Set the source preference to 5500A Calibrator or 5725A Amplifier, when a 5725A Amplifier is attached, which is saved in the 5500A non-volatile memory. (While saving configuration data in the non-volatile memory, a period of about 2 seconds, the 5500A does not respond to remote commands.) Source preference is used when an output value is programmed to a value that can be sourced by both the 5500A Calibrator and the 5725A Amplifier.

Parameters: P5500 (5500A Calibrator is the source preference)  
P5725 (5725A Amplifier is the source preference)

Example: SRC\_PREF P5725

Set the source preference to the 5725A Amplifier.

---



**SRC\_PREF?**  IEEE-488  RS-232  Sequential  Overlapped  Coupled

(Source Preference query) Return the source preference from 5500A Calibrator or 5725A Amplifier, when a 5725A Amplifier is attached.

Responses: P5500 (5500A Calibrator is set as the source preference)  
P5725 (5725A Amplifier is set as the source preference)

Example: SRC\_PREF? returns P5725

Return P5725 when the source preference is the 5725A Amplifier.

**\*SRE**  IEEE-488  RS-232  Sequential  Overlapped  Coupled

(Service Request Enable command) Load a byte into the Service Request Enable (SRE) register. (See “Service Request Enable Register (SRE)” in Chapter 5. Since bit 6 is not used (decimal value 64), the maximum entry is 255 - 64 = 191.

Parameter: <value> (the decimal equivalent of the SRE byte, 0 to 191)

Example: \*SRE 56

Enable bits 3 (EAV), 4 (MAV), and 5 (ESR).

**\*SRE?**  IEEE-488  RS-232  Sequential  Overlapped  Coupled

(Service Request Enable query) Return the byte in the Service Request Enable (SRE).

Response: <value> (the decimal equivalent of the SRE byte, 0 to 191)

Example: \*SRE? returns 56

Return 56 when bits 3 (EAV), 4 (MAV), and 5 (ESR) are enabled.

**SRQSTR**  IEEE-488  RS-232  Sequential  Overlapped  Coupled

(Service Request String command) Set the Serial Mode SRQ (Service Request) response (up to 40 characters) in the 5500A non-volatile memory. (While saving configuration data in the non-volatile memory, a period of about 2 seconds, the 5500A does not respond to remote commands.) The SRQSTR is sent to the host over the serial interface when the SRQ line is asserted (terminal mode only). Default format is:

SRQ: %02x %02x %04x %04x

where the term %02x (8 bits) means print the value in hexadecimal with exactly 2 hex digits, and %04x (16 bits) means print the value in hexadecimal with exactly 4 hex digits. The string representations are:

SRQ: (STB) (ESR) (ISCR0) (ISCR1)

See the commands, respectively, \*STB?, \*ESR?, ISCR0?, and ISCR1? A typical string in the default format sent to the host is: SRQ: 44 00 0000 1000. This command is for format. See the SPLSTR command for the serial poll response.

Parameter: "<string>\n" (\n represents the Line Feed character, hex 0A)

Example: SRQSTR "SRQ: %02x %02x %04x %04x\n"

Set the SRQSTR to the default values SRQ: %02x %02x %04x %04x\n.

**SRQSTR?**  IEEE-488  RS-232  Sequential  Overlapped  Coupled

(Service Request String query) Return the string programmed for Serial Mode SRQ response. This is the format of the Service Request String; actual values come from the registers. Also see the SPLSTR command.

Response: <string>

Example: SRQSTR returns SRQ: %02x %02x %04x %04x\n

Return the SRQSTR string format (default settings in this example).

---

**\*STB?**  IEEE-488  RS-232  Sequential  Overlapped  Coupled

(Status Byte Register command) Return the byte for the Status Byte Register. (See “Status Byte Register (STB)” in Chapter 5.)

Response: <value> (the decimal equivalent of the STB byte, 0 to 255)

Example: \*STB? returns 72

Return 72 if bits 3 (EAV) and 6 (MSS) are set.

---

**STBY**  IEEE-488  RS-232  Sequential  Overlapped  Coupled

(Standby command) Deactivate the 5500A Calibrator output if it is in operate. This is the same as pressing the 5500A Calibrator front panel  STBY key.

Parameter: (None)

Example: STBY

Disconnect the selected output from the 5500A Calibrator front panel terminals.

---

**TC\_MEAS**  IEEE-488  RS-232  Sequential  Overlapped  Coupled

(Thermocouple Measure command) Select the measure thermocouple mode.

Parameters: CEL (Celsius) (optional)  
FAR (Fahrenheit) (optional)

Example: TC\_MEAS CEL

Measure the thermocouple temperature that is attached to the 5500A Calibrator TC terminals, in Celsius.

---

**TC\_OFFSET**  IEEE-488  RS-232  Sequential  Overlapped  Coupled

(Thermocouple Temperature Measurement Offset command) Add a temperature offset to thermocouple measurements ( $\pm 500$  °C). This command does not apply to thermocouple sourcing.

Parameters: <value> CEL (offset in Celsius) (optional)  
<value> FAR (offset in Fahrenheit) (optional)

Example: TC\_OFFSET +10 CEL

Add a temperature offset of +10 °C to the thermocouple measurements.

---

**TC\_OFFSET?**  IEEE-488  RS-232  Sequential  Overlapped  Coupled

(Thermocouple Temperature Measurement Offset query) Return the temperature offset used for thermocouple measurements ( $\pm 500$  °C).

Responses: <value> CEL (offset in Celsius) (optional)  
 <value> FAR (offset in Fahrenheit) (optional)

Example: TC\_OFFSET? returns 1.000E+01, CEL

Return 10 Celsius when a temperature offset of +10 °C has been added to the thermocouple measurements.

---

**TC\_OTCD**  IEEE-488  RS-232  Sequential  Overlapped  Coupled

(Thermocouple Open Detection command) Activate or deactivate the open thermocouple detection circuit in thermocouple measurement mode. Once set, the 5500A Calibrator retains the open thermocouple detection circuit setting until power off or reset.

Parameters: ON (turn on thermocouple detection circuit) (default)  
 OFF (turn off thermocouple detection circuit)

Example: TC\_OTCD ON

Activate the open thermocouple detection circuit. If an open thermocouple is detected, this condition is displayed on the front panel.

---

**TC\_OTCD?**  IEEE-488  RS-232  Sequential  Overlapped  Coupled

(Thermocouple Open Detection query) Return the status of the open thermocouple detection circuit in thermocouple measurement mode.

Responses: ON (thermocouple detection circuit is on)  
 OFF (thermocouple detection circuit is off)

Example: TC\_OTCD? returns ON

Return ON when the open thermocouple detection circuit is activated.

---

**TC\_REF**  IEEE-488  RS-232  Sequential  Overlapped  Coupled

(Thermocouple Reference command) Set whether the internal temperature sensor (INT) or an external reference value (EXT) is used for Thermocouple (TC) outputs and measurements. If the first parameter is EXT, the second parameter must be the temperature value to use as the reference for the thermocouple reference junction temperature. Once set, the 5500A Calibrator retains the reference setting until power off or reset.

Parameters: INT  
 EXT, <value of external reference> CEL (or FAR)

Example: TC\_REF EXT, 25.6 CEL

Set the thermocouple reference to external, with a value of 25.6 °C.

---

**TC\_REF?**  IEEE-488  RS-232  Sequential  Overlapped  Coupled

(Thermocouple Reference query) Return the source and value of the temperature being used as a reference for thermocouple simulation and measurement (in Celsius, CEL, or Fahrenheit, FAR, depending on active units). The choices are Internal reference (INT) or External reference (EXT).

If INT is returned, the reference temperature return is 0 unless you are in a thermocouple mode of operation and the 5500A Calibrator is in Operate.

Responses: INT, <value of reference temperature>, CEL (or FAR)  
EXT, <value of reference temperature>, CEL (or FAR)

Example: TC\_REF? returns INT, 2.988E+01, CEL

Return Internal, 29.88, Celsius, when the thermocouple reference is internal and at 29.88 °C. (If the temperature return for the internal reference is 0 (0.00E+00), the 5500A Calibrator is not in Operate, and/or the Calibrator is not in a thermocouple mode.)

---

**TC\_TYPE**  IEEE-488  RS-232  Sequential  Overlapped  Coupled

(Thermocouple Type command) Set the Thermocouple (TC) temperature sensor type. The TC type is used when the output is set to a temperature value with the OUT command and the temperature sensor type is set to TC with the TSENS\_TYPE command. When the thermocouple type is changed while simulating a temperature output, the temperature is changed to 0 °C. Once set, the 5500A Calibrator retains the TC type until power off or reset.

Parameters: B (B-type thermocouple)  
C (C-type thermocouple)  
E (E-type thermocouple)  
J (J-type thermocouple)  
K (K-type thermocouple) (default)  
N (N-type thermocouple)  
R (R-type thermocouple)  
S (S-type thermocouple)  
T (T-type thermocouple)  
X (10 μV/°C linear output)

Example: TC\_TYPE J

Set the thermocouple type for simulating a temperature output to a J-type thermocouple.

---

**TC\_TYPE?**  IEEE-488  RS-232  Sequential  Overlapped  Coupled

(Thermocouple Type query) Return the Thermocouple (TC) temperature sensor type. When the thermocouple type is changed while simulating a temperature output, the temperature is changed to 0 °C.

Responses: B (B-type thermocouple)  
 C (C-type thermocouple)  
 E (E-type thermocouple)  
 J (J-type thermocouple)  
 K (K-type thermocouple) (default)  
 N (N-type thermocouple)  
 R (R-type thermocouple)  
 S (S-type thermocouple)  
 T (T-type thermocouple)  
 X (10 μV/°C linear output)

Example: TC\_TYPE? returns K

Return K when the thermocouple type for simulating a temperature output is a K-type thermocouple.

---

**TC\_TYPE\_D**  IEEE-488  RS-232  Sequential  Overlapped  Coupled

(Thermocouple Type Default command) Set the default thermocouple (TC) sensor type, which is saved in the 5500A non-volatile memory. (While saving configuration data in the non-volatile memory, a period of about 2 seconds, the 5500A does not respond to remote commands.) The TC type is set to the default at power on and reset.

Parameters: B (B-type thermocouple)  
 C (C-type thermocouple)  
 E (E-type thermocouple)  
 J (J-type thermocouple)  
 K (K-type thermocouple) (default)  
 N (N-type thermocouple)  
 R (R-type thermocouple)  
 S (S-type thermocouple)  
 T (T-type thermocouple)  
 X (10 μV/°C linear output)

Example: TC\_TYPE\_D J

Set the thermocouple type default to a type-J thermocouple.

---

**TC\_TYPE\_D?**  IEEE-488  RS-232  Sequential  Overlapped  Coupled

(Thermocouple Type Default query) Return the default thermocouple (TC) sensor type.

Responses: B (B-type thermocouple)  
C (C-type thermocouple)  
E (E-type thermocouple)  
J (J-type thermocouple)  
K (K-type thermocouple) (default)  
N (N-type thermocouple)  
R (R-type thermocouple)  
S (S-type thermocouple)  
T (T-type thermocouple)  
X (10  $\mu$ V/ $^{\circ}$ C linear output)

Example: TC\_TYPE\_D? returns K

Return K when the thermocouple type default is a type-K thermocouple.

---

**TEMP\_STD**  IEEE-488  RS-232  Sequential  Overlapped  Coupled

(Temperature Degree Standard command) Select the temperature standard ipts-68 (1968 International Provisional Temperature Standard) or its-90 (1990 International Temperature Standard), which is saved in the 5500A non-volatile memory. (While saving configuration data in the non-volatile memory, a period of about 2 seconds, the 5500A does not respond to remote commands.) The default is its-90.

Parameters: IPTS\_68  
ITS\_90

Example: TEMP\_STD ITS-90

See the temperature standard to its-90.

---

**TEMP\_STD?**  IEEE-488  RS-232  Sequential  Overlapped  Coupled

(Temperature Degree Standard command) Return the temperature standard ipts-68 (1968 International Provisional Temperature Standard) or its-90 (1990 International Temperature Standard).

Responses: IPTS\_68  
ITS\_90

Example: TEMP\_STD? returns ITS-90

Return ITS-90 when the temperature degree standard is the 1990 International Temperature Standard.

---

**\*TRG**  IEEE-488  RS-232  Sequential  Overlapped  Coupled

(Trigger Thermocouple Measurement command) Trigger a thermocouple temperature measurement and return the value of the measurement. Also change the operating mode to thermocouple measurement if this is not already the operating mode. (This command is equivalent to sending TC\_MEAS ; \*WAI ; VAL?)

Responses: <measurement value>, CEL (value is in Celsius)  
 <measurement value>, FAR (value is in Fahrenheit)  
 0.00E+00, OVER (value is over or under capability)  
 0.00E+00, OPENTC (open thermocouple)  
 0.00E+00, NONE (wrong mode or no measurement)

Example: \*TRG returns +2.500E+01, CEL

Trigger a thermocouple measurement and return 25.00 Celsius when the thermocouple temperature measurement is 25 °C.

---

**TSENS\_TYPE**  IEEE-488  RS-232  Sequential  Overlapped  Coupled

(Temperature Sensor Type command) Set the temperature sensor type to thermocouple (TC) or Resistance Temperature Detector (RTD) for temperature measurements. The 5500A Calibrator simulates the RTD temperature as a resistance output on the NORMAL terminals, and simulates the thermocouple temperature as a dc voltage output on the TC terminals. If the temperature sensor type is changed, the temperature output is reset to 0 degrees C. Once set, the 5500A Calibrator retains the temperature sensor type until power off or reset.

Parameters: TC (Thermocouple)  
 RTD (Resistance Temperature Detector)

Example: TSENS\_TYPE RTD

Set the temperature sensor type to an RTD.

---

**TSENS\_TYPE?**  IEEE-488  RS-232  Sequential  Overlapped  Coupled

(Temperature Sensor Type query) Return the temperature sensor type thermocouple (TC) or Resistance Temperature Detector (RTD) for temperature measurements.

Responses: TC (Thermocouple)  
 RTD (Resistance Temperature Detector)

Example: TSENS\_TYPE? returns TC

Return TC when the temperature sensor type is a thermocouple.

---

**\*TST?**  IEEE-488  RS-232  Sequential  Overlapped  Coupled

(Self Test command) Initiate self-test and return a 0 for pass or a 1 for fail. If any faults are detected, they are displayed on screen (terminal mode) or are logged into the fault queue where they can be read by the ERR? query (computer mode).

Response: 0 (pass self test)

1 (fail self test)

Example: \*TST? returns 1

Return 1 when self test is successful.

---

**UUT\_FLUSH**  IEEE-488  RS-232  Sequential  Overlapped  Coupled

(Flush UUT Receive Buffer command) Flush the UUT receive buffer for data received from the UUT over the 5500A Calibrator rear panel SERIAL 2 TO UUT serial port. The command may be sent over gpib or RS-232 ports, but applies to SERIAL 2 TO UUT serial port operation.

Parameter: (None)

Example: UUT\_FLUSH

Flush the 5500A Calibrator receive data buffer for the UUT.

---

**UUT\_RECV?**  IEEE-488  RS-232  Sequential  Overlapped  Coupled

(Return UUT Receive Data command) Return data from the UUT in IEEE-488.2 Standard format over the 5500A Calibrator rear panel SERIAL 2 TO UUT serial port. The command may be sent over gpib or RS-232 ports, but applies to SERIAL 2 TO UUT serial port operation.

Response: <data> (binary block data in definite length format from UUT)

Example: UUT\_RECV? returns #211+1.99975E+0

Return (for example) a measurement from the UUT. The format is #2 (two numbers follow) 11 (characters follow) +1.99975E+0 (11 characters).

---



**UUT\_SEND**  IEEE-488  RS-232  Sequential  Overlapped  Coupled

(Send UUT Data command) Send data to the UUT serial port in binary block or string data format over the 5500A Calibrator rear panel SERIAL 2 TO UUT serial port. The command may be sent over gpib or RS-232 ports, but applies to SERIAL 2 TO UUT serial port operation. Include a line feed (RS-232) character to terminate the block data or End or Identify (EOI) command (IEEE-488).

Parameter: #2<nn><nn characters string> (definite length)  
 #0<character string> (indefinite length)  
 "<character string"> (character string)

Examples:

UUT\_SEND #206F1S2R0 (definite length format)

Send the data F1S2R0 to the UUT in definite length format. The format is #2 (two numbers follow) 06 (characters follow) F1S2R0 (6 characters).

UUT\_SEND #0F1S2R0 (indefinite length format)

Send the data F1S2R0 to the UUT in indefinite length format. The format is #0 then the characters.

UUT\_SEND "F1S2R0" (character string)

Send the data F1S2R0 to the UUT as a character string.

**Special Case** When the character string sent to a UUT must end in a carriage return (CR) command or line feed (LF) command or both, you must use the following:

**Definite Length Format** Follow the instructions above and after the character string add a command ^J for CR or ^M for LF or both, where ^J means hold down the <Cntl> key and type the letter J. For example, sending the string REMS in this format with both CR and LF, you would count 4 characters for REMS and 1 character each for ^J and ^M for a total of 6 characters. The command would be UUT\_SEND #206REMS^J^M then <enter>. (The ^J and ^M "characters" actually perform the CR and LF functions.)

**Indefinite Length Format** This format may not be used when a character string requires CR and LF commands.

**Character String** Follow the instructions above and after the character string, add a \n for CR or \r for LF or both, where the alpha character is entered in lower case. For example, in the terminal mode to send the string REMS in this format with both CR and LF, the command would be UUT\_SEND "REMS\n\r". In the computer mode where commands are entered as part of a command string, use double quotes to show embedded quotes. For example, "uut\_send "REMS\n\r" " " .

The following characters and commands may be implemented as described above:

Carriage Return	^J	\n
Line Feed	^M	\r
Tab	Tab	\t
Backspace	^H	\b
Form Feed	^L	\f

**UUT\_SET**  IEEE-488  RS-232  Sequential  Overlapped  Coupled

(UUT Serial Port Set command) Set the RS-232-C settings for the 5500A Calibrator rear panel SERIAL 2 TO UUT serial port, which is saved in the 5500A non-volatile memory. (While saving configuration data in the non-volatile memory, a period of about 2 seconds, the 5500A does not respond to remote commands.) (To set the parameters for the rear panel SERIAL 1 FROM HOST serial port, see the SP\_SET command.) The factory default values are shown below in **bold** type. (To return to the factory defaults, see the FORMAT SETUP command.)

The interface selection sets the command response, with command echo back with TERM (terminal) and no echo back with COMP (computer).

Parameters: <baud rate value>, 300, 600, 1200, 2400, 4800, **9600**  
<flow control>, **XON** (xon/xoff), NOSTALL (none), RTS (rts/cts)  
<number data bits>, DBIT7 (7 bits) or **DBIT8** (8 bits)  
<number stop bits>, **SBIT1** (1 bit) or SBIT2 (2 bits)  
<parity> **PNONE** (none), PODD (odd), PEVEN (even)

Example: UUT\_SET 9600 , XON , DBIT8 , SBIT1 , PNONE

Set the parameters for the rear panel SERIAL 2 TO UUT serial port to the factory default values.

---

**UUT\_SET?**  IEEE-488  RS-232  Sequential  Overlapped  Coupled

(UUT Serial Port Set query) Return the RS-232-C settings for the 5500A Calibrator rear panel SERIAL 2 TO UUT serial port. (To return the parameters for the rear panel SERIAL 1 FROM HOST serial port, see the SP\_SET? command.) The factory default values are shown below in **bold** type. (To return to the factory defaults, see the FORMAT SETUP command.)

Responses: <baud rate value>, 300, 600, 1200, 2400, 4800, **9600**  
<flow control>, **XON** (xon/xoff), NOSTALL (none), RTS (rts/cts)  
<number data bits>, DBIT7 (7 bits) or **DBIT8** (8 bits)  
<number stop bits>, **SBIT1** (1 bit) or SBIT2 (2 bits)  
<parity> **PNONE** (none), PODD (odd), PEVEN (even)

Example: UUT\_SET? returns 9600 , XON , DBIT8 , SBIT1 , PNONE

Return the parameters for the rear panel SERIAL 2 TO UUT serial port, as shown, when set to the factory default values.

---

**VAL?**  IEEE-488  RS-232  Sequential  Overlapped  Coupled

(Thermocouple Measurement Value command) Return the last value of the thermocouple temperature measurement. The unit returns indicates the status of the reading.

Responses: <measurement value>, CEL (value is in Celsius)  
 <measurement value>, FAR (value is in Fahrenheit)  
 0.00E+00, OVER (value is over or under capability)  
 0.00E+00, OPENTC (open thermocouple)  
 0.00E+00, NONE (wrong mode or no measurement)

Example: VAL? returns 0.00E+00, NONE

Return 0 and NONE when there is no recent thermocouple measurement either because the 5500A Calibrator is not in the thermocouple measurement mode, or because no measurement has been made yet.

---

**VVAL?**  IEEE-488  RS-232  Sequential  Overlapped  Coupled

(Thermocouple Measurement Voltage command) Return the last value of the thermocouple temperature measurement in volts. If the last measurement was an overload or open thermocouple condition, or there is no measurement, return 0E+00.

Responses: <measurement value in volts> (valid measurement)  
 0E+00 (overload, open TC, or no measurement)

Example: VVAL? returns 1.1047E-03 (1.1047 mV, equivalent to 50°C with type K thermocouple and TC reference = 23.0°C)

---

**\*WAI**  IEEE-488  RS-232  Sequential  Overlapped  Coupled

(Wait-to-Continue command) Prevent further remote commands from being executed until all previous remote commands have been executed. For example, if you send an OUT command, you can cause the 5500A Calibrator to wait until the output has settled before continuing on to the next command if you follow OUT with a \*WAI command. The \*WAI command is useful with any overlapped command, preventing the 5500A Calibrator from processing other commands until the overlapped command is processed.

Example: \*WAI

Process all existing commands before continuing.

---

**WAVE**  IEEE-488  RS-232  Sequential  Overlapped  Coupled

(Waveform command) Set the waveforms for ac outputs. If the 5500A Calibrator is sourcing one output, one parameter is required. If the 5500A Calibrator is sourcing two outputs, two parameters are required or one parameter to set the waveform to both outputs. Waveform choices are SINE (sinewave), TRI (trianglewave), SQUARE (squarewave), TRUNCs (truncated sinewave), or NONE (waveform does not apply).

Parameter: <1st waveform> , (SINE, TRI, SQUARE, TRUNCs, NONE)  
<2nd waveform> (SINE, TRI, SQUARE, TRUNCs, NONE)

Example: WAVE SINE , SQUARE

Set the waveforms for a dual output to Sinewave on the primary output (5500A Calibrator front panel NORMAL terminals) and Squarewave on the secondary output (front panel AUX terminals).

---

**WAVE?**  IEEE-488  RS-232  Sequential  Overlapped  Coupled

(Waveform query) Return the waveform types for ac outputs. Waveform choices are SINE (sinewave), TRI (trianglewave), SQUARE (squarewave), TRUNCs (truncated sinewave), or NONE (waveform does not apply).

Responses: <1st waveform> , (SINE, TRI, SQUARE, TRUNCs, NONE)  
<2nd waveform> (SINE, TRI, SQUARE, TRUNCs, NONE)

Example: WAVE? returns SQUARE , NONE

Return SQUARE when the ac primary output (5500A Calibrator front panel NORMAL terminals) is a squarewave and NONE when there is no secondary output on the front panel AUX terminals.

---

**ZCOMP**  IEEE-488  RS-232  Sequential  Overlapped  Coupled

(Impedance Compensation command) Activate or deactivate 2-wire or 4-wire impedance compensation. For resistance output, compensation is allowed when the resistance is less than 110 k $\Omega$ . For capacitance output, compensation is allowed when the capacitance is equal to or greater than 110 nF. For all other resistances and capacitances, the compensation is NONE and attempts to use other parameters results in the error message "Can't change compensation now." For RTD temperature simulation, compensation is allowed for all temperatures.

Parameter: NONE (Turns off impedance compensation circuitry)  
WIRE2 (Turns on the 2-wire impedance compensation circuitry)  
WIRE4 (Turns on the 4-wire impedance compensation circuitry)

Example: ZCOMP WIRE2

Set 2-wire impedance compensation for the 5500A Calibration UUT connection. (Resistance if the ohms value is less than 110 k $\Omega$ , capacitance if the farads value is 110 nF or more, or RTD temperature simulation, any value.)

---

**ZCOMP?**  IEEE-488  RS-232  Sequential  Overlapped  Coupled

(Impedance Compensation query) Return status of 2-wire or 4-wire impedance compensation.

Responses: NONE (impedance compensation is turns off)  
WIRE2 (2-wire impedance compensation is on)  
WIRE4 (4-wire impedance compensation is off)

Example: ZCOMP? returns NONE

Return NONE when no impedance compensation is applied to the resistance, capacitance or RTD output.

---



# Chapter 7

## Maintenance

	<b>Contents</b>	<b>Page</b>
7-1.	Introduction.....	7-3
7-2.	Replacing the Line Fuse .....	7-3
7-3.	Cleaning the Air Filter .....	7-4
7-4.	General Cleaning .....	7-6
7-5.	Performing a Calibration Check .....	7-6
7-6.	Performance Tests .....	7-7
7-7.	DC Voltage Amplitude Accuracy (NORMAL) .....	7-7
7-8.	DC Voltage Amplitude Accuracy (AUX).....	7-8
7-9.	DC Current Amplitude Accuracy.....	7-9
7-10.	Resistance Accuracy .....	7-10
7-11.	Resistance DC Offset Measurement .....	7-11
7-12.	AC Voltage Amplitude Accuracy (NORMAL) .....	7-12
7-13.	AC Voltage Amplitude Accuracy (AUX).....	7-13
7-14.	AC Current Amplitude Accuracy.....	7-14
7-15.	Capacitance Accuracy.....	7-16
7-16.	Thermocouple Measurement Accuracy .....	7-17
7-17.	Thermocouple Sourcing Accuracy.....	7-17
7-18.	Thermocouple Measuring Accuracy.....	7-17
7-19.	DC Power Amplitude Accuracy (NORMAL).....	7-18
7-20.	DC Power Amplitude Accuracy (AUX) .....	7-18
7-21.	AC Power Amplitude Accuracy (High Voltage) .....	7-19
7-22.	AC Power Amplitude Accuracy (High Current).....	7-19
7-23.	AC Power Amplitude Accuracy (High Power).....	7-20
7-24.	Phase and Frequency Accuracy .....	7-21
7-25.	AC Voltage Amplitude Accuracy, Squarewave (NORMAL).....	7-22
7-26.	AC Voltage Amplitude Accuracy, Squarewave (AUX) .....	7-23
7-27.	AC Voltage Harmonic Amplitude Accuracy (NORMAL) .....	7-24
7-28.	AC Voltage Harmonic Amplitude Accuracy (AUX).....	7-25
7-29.	DC Voltage Offset Accuracy .....	7-25
7-30.	AC Voltage Accuracy with a DC Offset.....	7-26
7-31.	Non-Operator Fuse Replacement.....	7-26





## 7-1. Introduction

This chapter explains how to perform the routine maintenance and calibration task required to keep a normally operating 5500A Calibrator in service. These tasks include:

- Replacing the fuse
- Cleaning the air filter
- Cleaning the external surfaces
- Calibration verification

Refer to the Service manual for intensive maintenance tasks such as troubleshooting, calibration or repair, and all procedures that require opening the cover of the instrument. The Service Manual also contains complete verification procedures for checking that traceability to national standards maintained by the normal calibration procedure.

## 7-2. Replacing the Line Fuse

The line power fuse is accessible on the rear panel. The fuse rating label above the ac power input module shows the correct replacement fuse for each line voltage setting. Table 7-1 lists the fuse part numbers for each line voltage setting.

To check or replace the fuse, refer to Figure 7-1 and proceed as follows:

1. Disconnect line power.
2. The line power fuse and line voltage switch are located in a compartment on the right end of the ac input module. To open the compartment and remove the fuse, insert the blade of a standard screwdriver to the left of the tab located at the left side of the compartment cover.
3. Pry the tab out of the slot and the compartment cover will pop part way out.
4. Remove the compartment cover with your fingers.
5. The fuse comes out with the compartment cover and can be easily replaced.
6. To reinstall the fuse, push the compartment cover back into the compartment until the tab locks with the ac input module.

**Table 7-1. Replacement Fuses**

Part Number	Fuse Description	Line Voltage Setting
851931	2.5 A/250 V Time Delay	100 V or 120 V
851936	1.25 A/250 V Time Delay	200 V or 240 V
 To ensure safety, use exact replacement only		

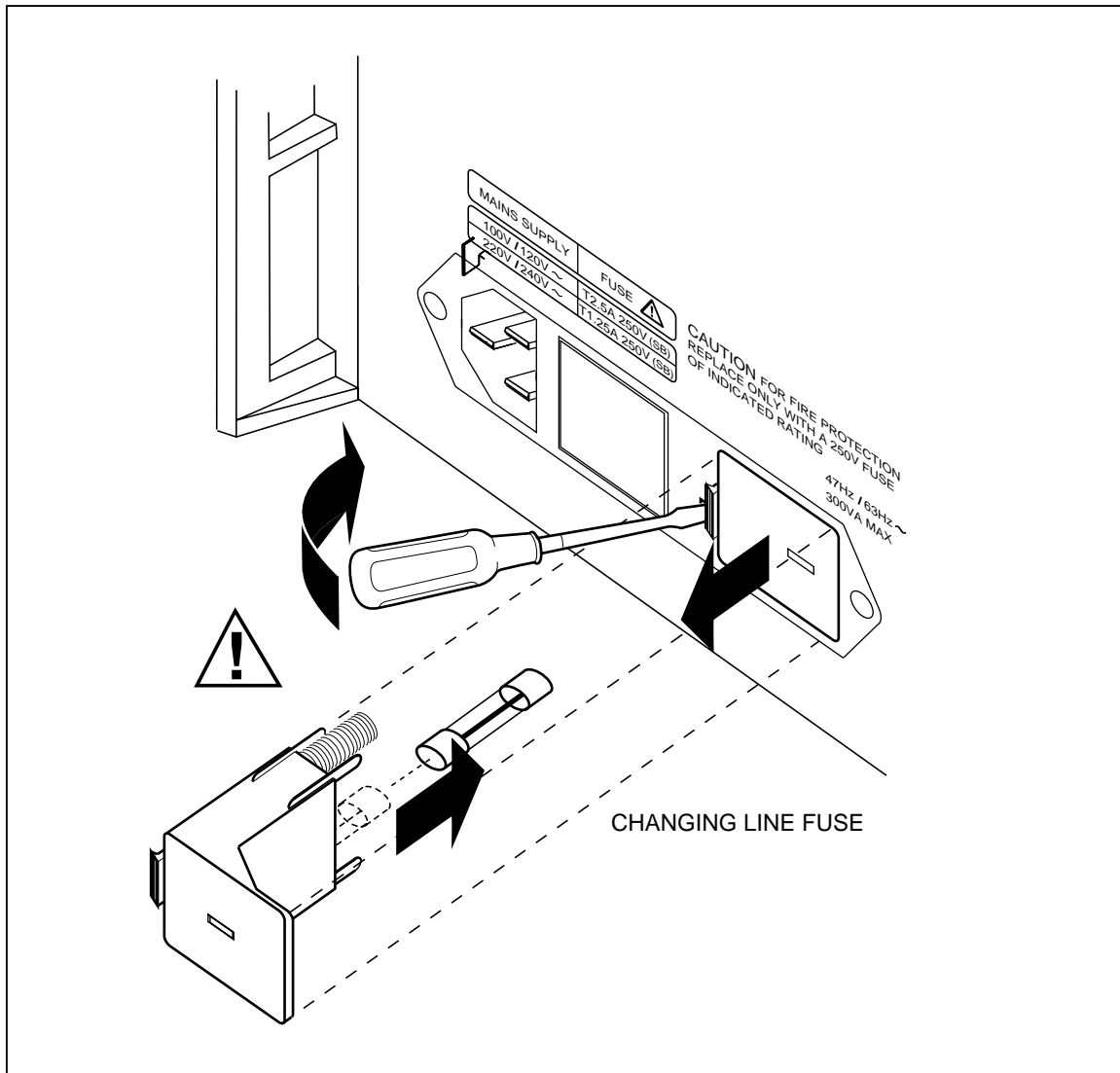

Figure 7-1. Accessing the Fuse

F7-01.eps

### 7-3. Cleaning the Air Filter

#### Warning

To avoid risk of injury, never operate or power the 5500A calibrator without the fan filter in place.

#### Caution

Damage caused by overheating may occur if the area around the fan is restricted, the intake air is too warm, or the filter becomes clogged.

The air filter must be removed and cleaned every 30 days or more frequently if the calibrator is operated in a dusty environment. The air filter is accessible from the rear panel of the calibrator.

To clean the air filter, refer to Figure 7-2 and proceed as follows:

1. Unplug the instrument.
2. Remove the filter element.
  - a. Grasp the top and bottom of the air filter frame.
  - b. Squeeze the edges of the frame towards each other to disengage the filter tabs from the slots in the calibrator.
  - c. Pull the filter frame straight out from the calibrator.
3. Clean the filter element.
  - a. Wash the filter element in soapy water.
  - b. Rinse the filter element thoroughly.
  - c. Shake out the excess water, then allow the filter element to dry thoroughly before reinstalling it.
4. Reinstall the filter element by performing the filter removal steps in reverse order.

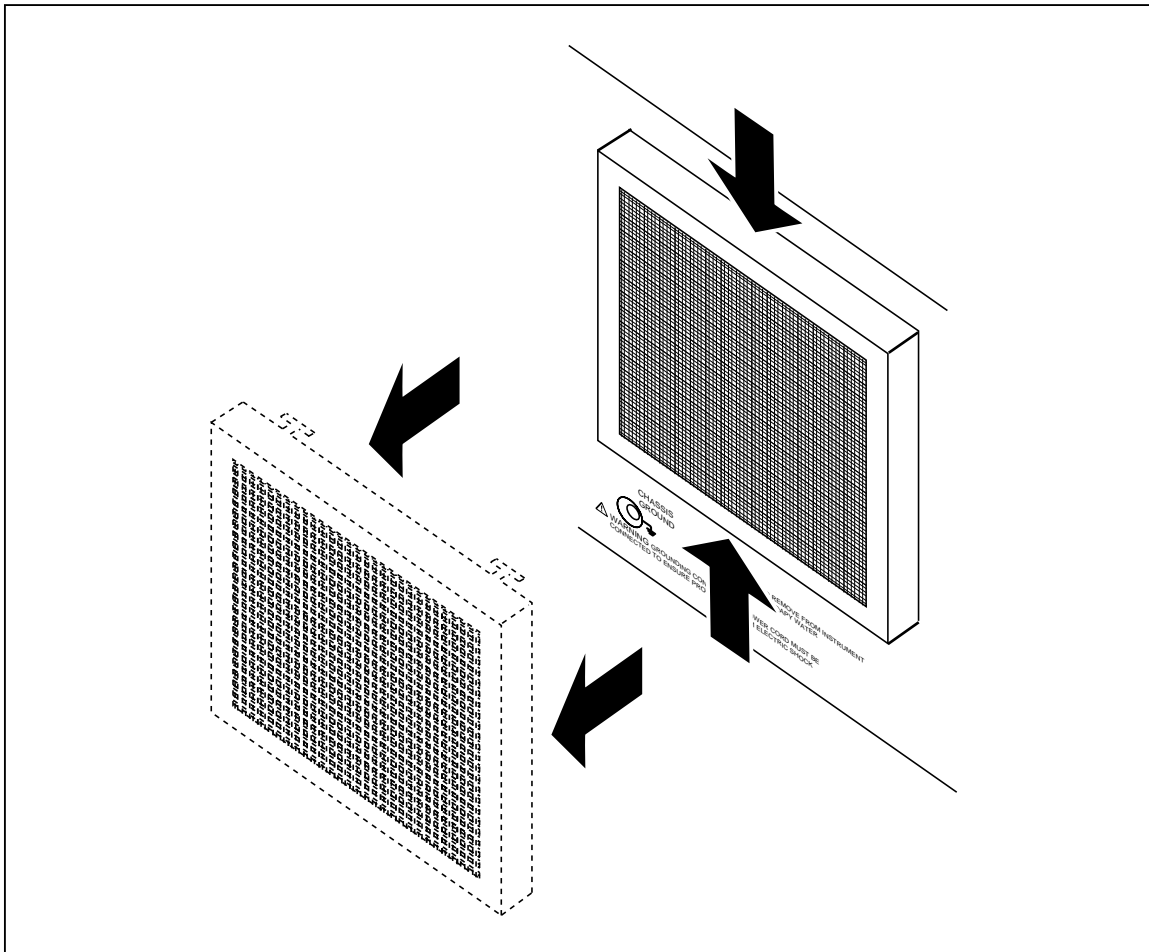

Figure 7-2. Accessing the Air Filter

F7-02.eps

## 7-4. General Cleaning

For general cleaning, wipe the case, front panel keys, and lens using a soft cloth slightly dampened with water or a non-abrasive mild cleaning solution that does not harm plastics.

### Caution

**Do not use aromatic hydrocarbons or chlorinated solvents for cleaning. They can damage the plastic materials used in the calibrator.**

## 7-5. Performing a Calibration Check

The following tests are used to verify the performance of the 5500A Calibrator. If an out-of-tolerance condition is found, the instrument can be re-calibrated using the front panel or the remote interface. The front panel calibration is self-prompting and takes you through the complete procedure. Complete details for calibrating the 5500A are provided in the 5500A Calibrator Service Manual (PN 105798).

The equipment listed in Table 7-2 are required to perform the calibration check. If a specific instrument is not available, a substitute instrument that assures a 4:1 Test Uncertainty Ratio may be substituted.

**Table 7-2. Required Equipment for Checking Calibration**

Equipment	Recommended Model	Purpose
test lead kit	5500-Leads	Provides test leads
8-1/2 digit DMM	HP 3458A w/ Opt -02	DC volts, Resistance
Mercury Thermometer	ASTM 56C	Internal temperature reference
100 mVDC source	Fluke 5500A, 5700A, 5440B, 5100B	Source for thermocouple measurements (characterize w/ the DMM, if necessary)
Phase Meter	Clarke-Hess 6000	Phase
LCR Meter	Fluke PM6304C/563 with PM9540/BAN test lead set	Capacitance
Counter/Timer	Fluke PM6680/456	Frequency
AC Measurement Standard	Fluke 5790A	ACV and ACI w/ shunts
Shunt	Fluke Y5020	10 A DC
Resistance Standard	Fluke 742A-1	300 mA DC
Resistance Standard	Fluke 742A-10	30 mA DC
Resistance Standard	Fluke 742A-100	3 mA DC
Resistance Standard	Fluke 742A-10M	Resistance at 320 MOhms
Current Shunt Adapter	Fluke 792A-7004	Assures compatibility w/ A40 shunts
AC Shunts	Fluke A40 (10m, 30m, 300m, 3A) & A40A-10	ACI
Interconnect cable for A40A	Fluke A45-4004	Cable adapter for A40A
Precision metal film resistors	1k Ohm, 1%, 100 ppm/°C or better	Current shunt for < 330 $\mu$ A (Determine value w/ the DMM)

**7-6. Performance Tests**

For the following performance tests, refer to Chapter 4, “Front Panel Operations,” for procedures on operating the 5500A from the front panel, or to Chapter 5, “Remote Operations,” for procedures on operating the 5500A from a terminal or computer. Also refer to Chapter 4 for connection information.

Zero the 5500A Calibrator before testing by completing “Zeroing the Calibrator” in Chapter 4.

The performance tests have reserved columns for recording the Measured Value and Deviation (%).

**7-7. DC Voltage Amplitude Accuracy (NORMAL)**

The DC Voltage Amplitude Accuracy test verifies the accuracy of dc voltage at the 5500A Calibrator front panel NORMAL terminals.

Range	Nominal Value	Measured Value	Deviation %	90-Day Spec. ( $\mu\text{V}$ or %)
330 mV	0.0000 mV			3.0 $\mu\text{V}$
330 mV	329 mV			0.0059%
330 mV	-329 mV			0.0059%
3.3 V	0.000 mV			5 $\mu\text{V}$
3.3 V	3.29 V			0.0042%
3.3 V	-3.29 V			0.0042%
33 V	0.00 mV			50 $\mu\text{V}$
33 V	32.9 V			0.0042%
33 V	-32.9 V			0.0042%
330 V	50 V			0.0055%
330 V	329 V			0.0047%
330 V	-50 V			0.0055%
330 V	-329 V			0.0047%
1020 V	334 V			0.0049%
1020 V	1020 V			0.0046%
1020 V	-334 V			0.0049%
1020 V	-1020 V			0.0046%

**7-8. DC Voltage Amplitude Accuracy (AUX)**

The DC Voltage Amplitude Accuracy test verifies the accuracy of dc voltage at the 5500A Calibrator front panel AUX terminals in the presence of a lower voltage at the NORMAL terminals.

Nominal Value (NORMAL)	Nominal Value (AUX)	Measured Value (AUX V)	Deviation %	90-Day Spec. (% or mV)
3 V	0 mV			0.350 mV
3 V	329 mV			0.1365%
3 V	-329 mV			0.1365%
3 V	0.33 V			0.1361%
3 V	3.29 V			0.0407%
3 V	-3.29 V			0.0407%

**7-9. DC Current Amplitude Accuracy**

The DC Voltage Amplitude Accuracy test verifies the accuracy of dc current at the 5500A Calibrator front panel AUX terminals.

Range	Nominal Value	Measured Value (A)	Deviation %	90-Day Spec. (% or mA)
3.3 mA	0 mA			0.00005 mA
3.3 mA	0.19 mA			0.036%
3.3 mA	-0.19 mA			0.036%
3.3 mA	1.9 mA			0.013%
3.3 mA	-1.9 mA			0.013%
3.3 mA	3.29 mA			0.012%
3.3 mA	-3.29 mA			0.012%
33 mA	0 mA			0.00025 mA
33 mA	19 mA			0.009%
33 mA	-19 mA			0.009%
33 mA	32.9 mA			0.009%
33 mA	-32.9 mA			0.009%
330 mA	0 mA			0.0033 mA
330 mA	190 mA			0.010%
330 mA	-190 mA			0.010%
330 mA	329 mA			0.009%
330 mA	-329 mA			0.009%
2.2 A	0A			0.000044A
2.2 A	2.19 A			0.025%
2.2 A	-2.19 A			0.025%
11 A	0 A			0.00033A
11 A	11 A			0.041%
11 A	-11 A			0.041%

**7-10. Resistance Accuracy**

The Resistance Accuracy test verifies the accuracy of synthesized resistance at the 5500A Calibrator front panel NORMAL terminals. For resistances of less than 110 k $\Omega$ , use the 4-wire COMP option. For resistances of 110 k $\Omega$  or higher, the COMP option is automatically turned off.

Nominal Value ( $\Omega$ )	Measured Value ( $\Omega$ )	Deviation %	90-Day Spec. (m $\Omega$ or %)
0 $\Omega$			6 m $\Omega$
2 $\Omega$			0.309%
10.9 $\Omega$			0.064%
11.9 $\Omega$			0.135%
19 $\Omega$			0.088%
30 $\Omega$			0.059%
33 $\Omega$			0.052%
109 $\Omega$			0.021%
119 $\Omega$			0.020%
190 $\Omega$			0.015%
300 $\Omega$			0.012%
330 $\Omega$			0.025%
1.09 k $\Omega$			0.012%
1.19 k $\Omega$			0.012%
1.9 k $\Omega$			0.010%
3 k $\Omega$			0.009%
3.3 k $\Omega$			0.025%
10.9 k $\Omega$			0.012%
11.9 k $\Omega$			0.012%
19 k $\Omega$			0.010%
30 k $\Omega$			0.009%
33 k $\Omega$			0.026%
109 k $\Omega$			0.013%
119 k $\Omega$			0.014%
190 k $\Omega$			0.012%
300 k $\Omega$			0.011%
330 k $\Omega$			0.028%
1.09 M $\Omega$			0.016%
1.19 M $\Omega$			0.016%
1.9 M $\Omega$			0.014%
3 M $\Omega$			0.013%
3.3 M $\Omega$			0.062%



*Resistance Accuracy (cont)*

Nominal Value ( $\Omega$ )	Measured Value ( $\Omega$ )	Deviation %	90-Day Spec. (m $\Omega$ or %)
10.9 M $\Omega$			0.050%
11.9 M $\Omega$			0.080%
19 M $\Omega$			0.078%
30 M $\Omega$			0.077%
33 M $\Omega$			0.415%
109 M $\Omega$			0.406%
119 M $\Omega$			0.413%
290 M $\Omega$ [1]			0.403%

[1] This test can be performed using the HP 3458A in the 10 M $\Omega$  range and the Fluke 742A-10M in parallel with the 5500A output. Using exactly 10 M $\Omega$ , the nominal value is 9.66667 M $\Omega$ .

**7-11. Resistance DC Offset Measurement**

*Note*

*This verification test is optional. It is not necessary to guarantee the full calibration of the instrument. However, it may be useful when troubleshooting an instrument when other functions and/or parameters are incorrect.*

The Resistance DC Offset Measurement test checks the dc offset of the amplifiers used in the Synthesized resistance. Prior to performing this test, make sure you zero the 5500A Calibrator following the “Zeroing the Calibrator” procedure in Chapter 4. Set the output to 100  $\Omega$ , COMP OFF, and measure the NORMAL terminals with a dc meter (see Table 7-2).

Range	Nominal Value	Measured Value (V)	Deviation %	8-Hour Spec.
100 $\Omega$	0.000 mV			0.010 mV

**7-12. AC Voltage Amplitude Accuracy (NORMAL)**

The AC Voltage Amplitude Accuracy test verifies the accuracy of ac voltage at the 5500A Calibrator front panel NORMAL terminals.

Nominal Value (V)	Frequency (Hz)	Measured Value (V)	Deviation %	90-Day Spec. (%)
30 mV	9.5 Hz			5.550%
30 mV	10 Hz			0.327%
30 mV	45 Hz			0.177%
30 mV	1 kHz			0.177%
30 mV	10 kHz			0.177%
30 mV	20 kHz			0.217%
30 mV	50 kHz			0.257%
30 mV	100 kHz			0.370%
30 mV	450 kHz			0.950%
300 mV	9.5 Hz			5.550%
300 mV	10 Hz			0.207%
300 mV	45 Hz			0.047%
300 mV	1 kHz			0.047%
300 mV	10 kHz			0.047%
300 mV	20 kHz			0.087%
300 mV	50 kHz			0.133%
300 mV	100 kHz			0.227%
300 mV	500 kHz			0.640%
3 V	9.5 Hz			5.550%
3 V	10 Hz			0.118%
3 V	45 Hz			0.022%
3 V	1 kHz			0.022%
3 V	10 kHz			0.022%
3 V	20 kHz			0.062%
3 V	50 kHz			0.110%
3 V	100 kHz			0.227%
3 V	450 kHz			0.490%
30 V	9.5 Hz			5.550%
30 V	10 Hz			0.118%
30 V	45 Hz			0.032%
30 V	1 kHz			0.032%
30 V	10 kHz			0.032%
30 V	20 kHz			0.069%
30 V	50 kHz			0.157%
30 V	90 kHz			0.227%

**AC Voltage Amplitude Accuracy (NORMAL) (cont)**

Nominal Value (V)	Frequency (Hz)	Measured Value (V)	Deviation %	90-Day Spec. (%)
300V	45 Hz			0.042%
300V	1 kHz			0.042%
300V	10 kHz			0.065%
300V	18 kHz			0.081%
1020V	45 Hz			0.048%
1020V	1 kHz			0.048%
1020V	5 kHz			0.160%
1020V	8 kHz (10 kHz optional)			0.200%

**7-13. AC Voltage Amplitude Accuracy (AUX)**

The AC Voltage Amplitude Accuracy test verifies the accuracy of ac voltage at the 5500A Calibrator front panel AUX terminals in the presence of a voltage at the NORMAL terminals.

Nominal value (V) (NORMAL)	Nominal Value (V) (AUX)	Frequency (Hz)	Measured Value (AUX V)	Deviation %	90-Day Spec. (%)
300 mV	10 mV	45 Hz			3.780%
300 mV	10 mV	1 kHz			3.780%
300 mV	10 mV	5 kHz			4.650%
300 mV	10 mV	10 kHz			4.800%
300 mV	300 mV	9.5 Hz			5.550%
300 mV	300 mV	10 Hz			0.273%
300 mV	300 mV	45 Hz			0.203%
300 mV	300 mV	1 kHz			0.203%
300 mV	300 mV	5 kHz			0.300%
300 mV	300 mV	10 kHz			0.450%
300 mV	3 V	9.5 Hz			5.550%
300 mV	3 V	10 Hz			0.165%
300 mV	3 V	45 Hz			0.085%
300 mV	3 V	1 kHz			0.085%
300 mV	3 V	5 kHz			0.197%
300 mV	3 V	10 kHz			0.347%
<i>Note</i>					
<i>The verification tests below are optional. It is not necessary to guarantee the full calibration of the instrument. However, it may be useful when troubleshooting an instrument when other functions and/or parameters are incorrect.</i>					
1000 V	10 mV	45 Hz			3.780%
1000 V	100 mV	1 kHz			0.450%
500 V	100 mV	5 kHz			0.600%
250 V	1 V	10 kHz			0.440%

**7-14. AC Current Amplitude Accuracy**

The AC Voltage Amplitude Accuracy test verifies the accuracy of ac current at the 5500A Calibrator front panel AUX terminals.

Nominal Value (A)	Frequency (Hz)	Measured Value (A)	Deviation %	90-Day Spec. (%)
33 $\mu$ A	1 kHz			0.848%
33 $\mu$ A	10 kHz			1.395%
190 $\mu$ A	45 Hz			0.169%
190 $\mu$ A	1 kHz			0.222%
190 $\mu$ A	10 kHz			1.019%
329 $\mu$ A	10 Hz			0.236%
329 $\mu$ A	45 Hz			0.136%
329 $\mu$ A	1 kHz			0.166%
329 $\mu$ A	5 kHz			0.346%
329 $\mu$ A	10 kHz			0.986%
0.33 mA	1 kHz			0.171%
0.33 mA	5 kHz			0.241%
1.9 mA	1 kHz			0.096%
1.9 mA	10 kHz			0.466%
3.29 mA	10 Hz			0.159%
3.29 mA	45 Hz			0.089%
3.29 mA	1 kHz			0.089%
3.29 mA	5 kHz			0.159%
3.29 mA	10 kHz			0.459%
3.3 mA	1 kHz			0.161%
3.3 mA	5 kHz			0.241%
19 mA	1 kHz			0.086%
19 mA	10 kHz			0.466%
32.9 mA	10 Hz			0.159%
32.9 mA	45 Hz			0.079%
32.9 mA	1 kHz			0.079%
32.9 mA	5 kHz			0.159%
32.9 mA	10 kHz			0.459%
33 mA	1 kHz			0.161%
33 mA	5 kHz			0.241%
190 mA	1 kHz			0.086%
190 mA	10 kHz			0.466%
329 mA	10 Hz			0.159%
329 mA	45 Hz			0.080%
329 mA	1 kHz			0.080%

*AC Current Amplitude Accuracy (cont)*

Nominal Value (A)	Frequency (Hz)	Measured Value (A)	Deviation %	90-Day Spec. (%)
329 mA	5 kHz			0.159%
329 mA	10 kHz			0.459%
0.33 A	1 kHz			0.171%
0.33 A	5 kHz			0.791%
2.19 A	45 Hz			0.094%
2.19 A	1 kHz			0.094%
2.19 A	5 kHz			0.714%
2.2 A	500 Hz			0.171%
2.2 A	1 kHz			0.471%
11 A	45 Hz			0.068%
11 A	500 Hz			0.098%
11 A	1 kHz			0.268%

### 7-15. Capacitance Accuracy

The Capacitance Accuracy test verifies the accuracy of the synthesized capacitance output at the 5500A Calibrator front panel AUX terminals. Use the Fluke 6304C LCR Meter with PM9540/BAN output cable. This cable eliminates the need for a four-wire connection.

*Note*

*Make sure there are no other connections to the 5500A, especially the SCOPE BNC. Connecting any additional grounds to the 5500A can cause erroneous capacitance outputs. To overcome a noise problem, increase the meter's signal current by increasing either the frequency (which will decrease the capacitance) or the voltage level.*

Nominal value (nF)	LCR Stimulus Frequency (Hz)	Measured Value (F)	Deviation %	90-Day Spec. (%)
0.35 nF	1 kHz			3.23%
0.48 nF	1 kHz			2.46%
0.6 nF	1 kHz			2.05%
1 nF	1 kHz			1.38%
1.2 nF	1 kHz			1.22%
3 nF	1 kHz			0.71%
3.3 nF	1 kHz			0.68%
10.9 nF	1 kHz			0.47%
12 nF	1 kHz			1.03%
30 nF	1 kHz			0.52%
33 nF	1 kHz			0.49%
109 nF	1 kHz			0.28%
120 nF	1 kHz			0.44%
300 nF	1 kHz			0.29%
330 nF	100 Hz			0.49%
1.09 $\mu$ F	100 Hz			0.28%
1.2 $\mu$ F	100 Hz			0.51%
3 $\mu$ F	100 Hz			0.36%
3.3 $\mu$ F	100 Hz			0.56%
10.9 $\mu$ F	100 Hz			0.35%
12 $\mu$ F	100 Hz			0.55%
30 $\mu$ F	100 Hz			0.40%
33 $\mu$ F	100 Hz			0.68%
109 $\mu$ F	100 Hz			0.47%
120 $\mu$ F	100 Hz			0.75%
300 $\mu$ F	100 Hz			0.60%
330 $\mu$ F	50 Hz			1.09%
1.1 mF	50 Hz			1.03%

**7-16. Thermocouple Measurement Accuracy**

The Thermocouple Measurement Accuracy test checks the internal temperature reference. To perform this test, measure a lag bath temperature within  $\pm 5\text{ }^{\circ}\text{C}$  of the 5500A. Set the 5500A to Internal Reference, J thermocouple type. (See “Setting Temperature Simulation (Thermocouple)” in Chapter 4.) Make connections with J-type thermocouple wire.

Nominal Value ( $^{\circ}\text{C}$ )	5500A Reads ( $^{\circ}\text{C}$ )	Deviation $^{\circ}\text{C}$	90-Day Spec. ( $^{\circ}\text{C}$ )
Lag bath temp.			0.1

**7-17. Thermocouple Sourcing Accuracy**

The Thermocouple Sourcing Accuracy test checks the accuracy of the thermocouple sourcing circuitry. For this test, measure the dc output at the 5500A front panel TC connector with a dc meter (observe polarity on the TC connector). Select External Reference, and the linear output  $10\mu\text{V}/^{\circ}\text{C}$  as the thermocouple “type.” (See “Setting Temperature Simulation (Thermocouple)” in Chapter 4.)

Nominal Value ( $^{\circ}\text{C}$ )	Equivalent Value (mV)	Measured Value (mV)	Deviation %	90-Day Spec. (mV or %)
$0^{\circ}\text{C}$	0.000 mV			0.003 mV
$100^{\circ}\text{C}$	1.000 mV			0.305%
$-100^{\circ}\text{C}$	-1.000 mV			0.305%
$1000^{\circ}\text{C}$	10.000 mV			0.035%
$-1000^{\circ}\text{C}$	-10.000 mV			0.035%
$10000^{\circ}\text{C}$	100.000 mV			0.008%
$-10000^{\circ}\text{C}$	-100.000 mV			0.008%

**7-18. Thermocouple Measuring Accuracy**

The Thermocouple Measuring Accuracy tests the accuracy of the thermocouple measuring circuitry. For this test, input a dc voltage into the 5500A front panel TC terminals using copper plugs and wire (observe polarity on the TC connector), select External Reference, and the linear output  $10\mu\text{V}/^{\circ}\text{C}$  as the thermocouple “type.” (See “Setting Temperature Simulation (Thermocouple)” in Chapter 4.)

(Optional: You can also source a known temperature using a J-type thermocouple connection and Internal Reference. Source  $0^{\circ}\text{C}$ ,  $100^{\circ}\text{C}$ ,  $1000^{\circ}\text{C}$ , and  $-200^{\circ}\text{C}$ .)

Input Value (V)	Nominal Reading ( $^{\circ}\text{C}$ )	Actual Reading (mV)	Deviation %	90-Day Spec. (mV or %)
0 V	$0.00^{\circ}\text{C}$			0.003 mV
100 mV	$10,000.00^{\circ}\text{C}$			0.008%
-100 mV	$-10,000.00^{\circ}\text{C}$			0.008%

### 7-19. DC Power Amplitude Accuracy (NORMAL)

*Note*

*This verification test is optional. It is not necessary to guarantee the full calibration of the instrument. However, it may be useful when troubleshooting an instrument when other functions and/or parameters are incorrect.*

The DC Power Amplitude Accuracy (NORMAL) tests the amplitude accuracy of the dc power of the NORMAL terminals.

Nominal Value (V) (NORMAL)	Nominal Value (A) (AUX)	Measured Value (V) (NORMAL)	Deviation %	90-Day Spec. (%)
20 mV	2.19 A			0.020%
20 mV	11 A			0.020%

### 7-20. DC Power Amplitude Accuracy (AUX)

*Note*

*This verification test is optional. It is not necessary to guarantee the full calibration of the instrument. However, it may be useful when troubleshooting an instrument when other functions and/or parameters are incorrect.*

The DC Power Amplitude Accuracy (AUX) tests the amplitude accuracy of the dc power output of the AUX terminals.

Nominal Value (V) (NORMAL)	Nominal Value (A) (AUX)	Measured Value (A) (AUX)	Deviation %	90-Day Spec. (%)
1000 V	100 $\mu$ A			0.06%
1000 V	1 mA			0.015%
329 V	2.19 A			0.025%
1000 V	11 A			0.041%



**7-21. AC Power Amplitude Accuracy (High Voltage)**

*Note*

*This verification test is optional. It is not necessary to guarantee the full calibration of the instrument. However, it may be useful when troubleshooting an instrument when other functions and/or parameters are incorrect.*

The AC Power Amplitude Accuracy (High Voltage) tests the current outputs at the AUX terminals in the presence of a high voltage.

Nominal Value (V) (NORMAL)	Nominal Value (A) (AUX)	Frequency Hz	Phase (degrees)	Measured Value (A) (AUX)	Deviation %	90-Day Spec. (%)
1000 V	3.3 mA	65 Hz	0			0.161%
1000 V	3.3 mA	65 Hz	90			0.161%
1000 V	33 mA	500 Hz	0			0.161%
1000 V	33 mA	500 Hz	90			0.161%
1000 V	33 mA	1 kHz	0			0.161%
1000 V	33 mA	5 kHz	0			0.241%
1000 V	33 mA	7 kHz (10 kHz optional)	0			0.541%
(Optional) 800 V	33 mA	10 kHz				0.541%

**7-22. AC Power Amplitude Accuracy (High Current)**

*Note*

*This verification test is optional. It is not necessary to guarantee the full calibration of the instrument. However, it may be useful when troubleshooting an instrument when other functions and/or parameters are incorrect.*

The AC Power Amplitude Accuracy (High Current) tests the voltage outputs at the NORMAL terminals in the presence of a high current.

Nominal Value (V) (NORMAL)	Nominal Value (A) (AUX)	Frequency Hz	Phase (degrees)	Measured Value (V) (NORMAL)	Deviation %	90-Day Spec. (%)
33 mV	11 A	65 Hz	0			0.101%
33 mV	11 A	65 Hz	90			0.101%
330 mV	11 A	1 kHz	0			0.038%
3.3 V	2.19 A	5 kHz	0			0.048%
3.3 V	329 mA	10 kHz	0			0.048%

### 7-23. AC Power Amplitude Accuracy (High Power)

*Note*

*This verification test is optional. It is not necessary to guarantee the full calibration of the instrument. However, it may be useful when troubleshooting an instrument when other functions and/or parameters are incorrect.*

The AC Power Amplitude Accuracy (High Power) tests the accuracy of the ac power output at high power levels.

Nominal Value (V) (NORMAL)	Nominal Value (A) (AUX)	Frequency	Phase (degrees)	Measured Value (V) (NORMAL)	Deviation %	90-Day Spec.
329 V	2.19 A	5 kHz	0			0.065%
1 kV	11 A	1 kHz	0			0.048%

**7-24. Phase and Frequency Accuracy**

The Phase and Frequency Accuracy tests the phase and frequency configurations. For the phase test, ac couple the input to the phase meter. For the current outputs, measure the phase across a non-inductive resistor.

**Phase**

Output Voltage (NORMAL)	Output Voltage (AUX)	Frequency (Hz)	Nominal Phase (degrees)	Measured Value (degrees)	Deviation %	1-Year Spec. (degrees)
3 V	1 V	60 Hz	0			0.15
3 V	1 V	400 Hz	0			0.9
3 V	1 V	1 kHz	0			2
3 V	1 V	5 kHz	0			6
3 V	1 V	10 kHz	0			10
3 V	1 V	60 Hz	60			0.15
3 V	1 V	400 Hz	60			0.9
3 V	1 V	1 kHz	60			2
3 V	1 V	5 kHz	60			6
3 V	1 V	10 kHz	60			10
3 V	1 V	60 Hz	90			0.15
3 V	1 V	400 Hz	90			0.9
3 V	1 V	1 kHz	90			2
3 V	1 V	5 kHz	90			6
3 V	1 V	10 kHz	90			10
33 V	300 mA	65 Hz	0			0.15
33 V	2 A	65 Hz	0			0.15
33 V	5 A	65 Hz	0			0.15
33 V	5 A	400 Hz	0			0.9

**Frequency**

Output Voltage (NORMAL)	Frequency (Hz)	Measured Value (Hz)	Deviation ppm	1-Year Spec. (ppm)
3 V	119.00 Hz			42
3 V	120.0 Hz			42
3 V	1000.0 Hz			27
3 V	100.00 kHz			25

**7-25. AC Voltage Amplitude Accuracy, Squarewave (NORMAL)**

*Note*

*This verification test is optional. It is not necessary to guarantee the full calibration of the instrument. However, it may be useful when troubleshooting an instrument when other functions and/or parameters are incorrect.*

The AC Voltage Amplitude Accuracy, Squarewave (NORMAL) tests the amplitude accuracy at the NORMAL terminals. For this test, use the Fluke 5790A, an rms-responding meter. For squarewaves, the measured value (in rms) should be exactly 1/2 the nominal value in peak-to-peak.

Nominal Value (V p-p)	Frequency (Hz)	Measured Value (V rms)	Deviation %	1-Year Spec. (%)
30 mV (15 mV rms)	10 Hz			1.350%
30 mV	1 kHz			0.800%
30 mV	20 kHz			1.050%
30 mV	100 kHz			6.100%
300 mV (150 mV rms)	10 Hz			1.350%
300 mV	1 kHz			0.800%
300 mV	20 kHz			1.050%
300 mV	100 kHz			6.100%
3 V (1.5V rms)	10 Hz			1.350%
3 V	1 kHz			0.800%
3 V	20 kHz			1.050%
3 V	100 kHz			6.100%
30 V (15 V rms)	10 Hz			1.350%
30 V	1 kHz			0.800%
30 V	20 kHz			1.050%
30 V	100 kHz			6.100%

**7-26. AC Voltage Amplitude Accuracy, Squarewave (AUX)**

*Note*

*This verification test is optional. It is not necessary to guarantee the full calibration of the instrument. However, it may be useful when troubleshooting an instrument when other functions and/or parameters are incorrect.*

The AC Voltage Amplitude Accuracy, Squarewave (AUX) tests the amplitude accuracy at the AUX terminals. For this test, use the Fluke 5790A, and an rms-responding meter. For squarewaves, the measured value (in rms) should be exactly half the nominal peak-to-peak value.

Nominal Value (V p-p) NORMAL	Nominal Value (V p-p) (AUX)	Frequency (Hz)	Measured Value (AUX V rms)	Deviation %	1-Year Spec. (%)
3 V	300 mV	10 Hz			1.350%
3 V	300 mV	1 kHz			0.800%
3 V	300 mV	5 kHz			6.100%
3 V	300 mV	10 kHz			6.100%
3 V	3 V	10 Hz			1.350%
3 V	3 V	1 kHz			0.800%
3 V	3 V	5 kHz			6.100%
3 V	3 V	10 kHz			6.100%

**7-27. AC Voltage Harmonic Amplitude Accuracy (NORMAL)**

*Note*

*This verification test is optional. It is not necessary to guarantee the full calibration of the instrument. However, it may be useful when troubleshooting an instrument when other functions and/or parameters are incorrect.*

The AC Voltage Harmonic Amplitude Accuracy (NORMAL) tests the accuracy of the harmonics from the NORMAL terminals. For this test, set the 5500A output to sinewave.

Nominal Value (V) (NORMAL)	Nominal Value (V) (AUX)	Frequency (Hz) (AUX)	Harmonic (NORMAL)	Frequency (Hz) (NORMAL)	Measured Value (V) (NORMAL)	Deviation %	90-Day Spec. (%)
30 mV	300 mV	20 Hz	50th	1 kHz			0.243%
30 mV	300 mV	100 Hz	50th	5 kHz			0.243%
30 mV	300 mV	200 Hz	50th	10 kHz			0.243%
300 mV	300 mV	20 Hz	50th	1 kHz			0.053%
300 mV	300 mV	100 Hz	50th	5 kHz			0.053%
300 mV	300 mV	200 Hz	50th	10 kHz			0.053%
3 V	3 V	20 Hz	50th	1 kHz			0.024%
3 V	3 V	100 Hz	50th	5 kHz			0.024%
3 V	3 V	200 Hz	50th	10 kHz			0.024%
30 V	3 V	20 Hz	50th	1 kHz			0.034%
30 V	3 V	100 Hz	50th	5 kHz			0.034%
30 V	3 V	200 Hz	50th	10 kHz			0.034%
300 V	3 V	50 Hz	20th	1 kHz			0.044%
300 V	3 V	100 Hz	50th	5 kHz			0.070%
300 V	3 V	200 Hz	50th	10 kHz			0.070%
1000 V	3 V	50 Hz	20th	1 kHz			0.056%
1000 V	3 V	100 Hz	50th	5 kHz			0.170%
800 V	3 V	200 Hz	50th	10 kHz			0.275%
Optional: 1000 V	3 V	200 Hz	50th	10 kHz			0.250%

**7-28. AC Voltage Harmonic Amplitude Accuracy (AUX)**

*Note*

*This verification test is optional. It is not necessary to guarantee the full calibration of the instrument. However, it may be useful when troubleshooting an instrument when other functions and/or parameters are incorrect.*

The AC Voltage Harmonic Amplitude Accuracy (AUX) tests the accuracy of the 50th harmonic from the AUX terminals. For this test, set the 5500A output to sinewave.

Nominal Value (V) (NORMAL)	Nominal Value (V) (AUX)	Frequency (Hz) (AUX)	Frequency (Hz) (NORMAL)	Measured Value (V) (AUX)	Deviation %	90-Day Spec (%)
100 mV	329 mV	1 kHz	20 Hz			0.305%
100 mV	329 mV	5 kHz	100 Hz			0.424%
100 mV	329 mV	10 kHz	200 Hz			0.574%
100 mV	3.29 V	1 kHz	20 Hz			0.097%
100 mV	3.29 V	5 kHz	100 Hz			0.235%
100 mV	3.29 V	10 kHz	200 Hz			0.385%

**7-29. DC Voltage Offset Accuracy**

*Note*

*This verification test is optional. It is not necessary to guarantee the full calibration of the instrument. However, it may be useful when troubleshooting an instrument when other functions and/or parameters are incorrect.*

The DC Voltage Offset Accuracy test the accuracy of the dc offset function for an ac sinewave output on the NORMAL terminals.

Nominal ACV Value (V)	Nominal DC Value (V)	Frequency (Hz)	Measured Value (VDC)	Deviation %	1-Year Spec. ( $\mu$ V or %)
10 mV	0 V	1 kHz			33 $\mu$ V
10 mV	50 mV	1 kHz			0.166%
100 mV	0 V	1 kHz			330 $\mu$ V
100 mV	500 mV	1 kHz			0.166%
1 V	0 V	1 kHz			3.3 mV
1 V	5 V	1 kHz			0.166%
3.3 V	0 V	1 kHz			33 mV
3.3 V	45 V	1 kHz			0.173%

### 7-30. AC Voltage Accuracy with a DC Offset

*Note*

*This verification test is optional. It is not necessary to guarantee the full calibration of the instrument. However, it may be useful when troubleshooting an instrument when other functions and/or parameters are incorrect.*

The AC Voltage Accuracy with a DC Offset tests the accuracy of the ac output in the presence of a dc offset. For this test, be sure to ac couple the input to the meter.

Nominal ACV Value (V)	Nominal DC Value (V)	Frequency (Hz)	Measured Value (VAC)	Deviation %	90-Day Spec. (%)
3.3 mV	50 mV	1 kHz			0.716%
33 mV	500 mV	1 kHz			0.101%
330 mV	5 V	1 kHz			0.038%
3.3 V	45 V	1 kHz			0.048%

### 7-31. Non-Operator Fuse Replacement

In addition to the operator-replaceable line fuse (see “Replacing the Line Fuse”), there are additional fuses mounted on printed circuit assemblies (PCAs) internal to the 5500A Calibrator. The internal fuses are summarized in Table 7-3 and are not operator-replaceable. For instructions on replacing a PCA fuse, refer to the 5500A Service Manual (PN 105798).

**Table 7-3. Non-Operator Fuse Replacement Locations**

Fuse Description	Printed Circuit Assembly	Reference	Quantity	Part Number
0.125 A, 250 V, Slow Blow	A5, Synth Z Board	A5F2, A5F3	2	832261
0.5 A, 250 V, Slow Blow	A12, Filter Board	A12F1, A12F2	2	831990
2 A, 250 V, Slow Blow	A3, Mother Board	A3F1 to A3F10	10	806331
⚠ To ensure safety, use exact replacement only				



## ***Chapter 8***

# ***Oscilloscope Calibration Options***

- Option 5500A-SC600: see page 8-3.
- Option 5500A-SC300: see page 8-57.



# 5500A-SC600 Option

	<b>Contents</b>	<b>Page</b>
8-1.	Introduction.....	8-5
8-2.	SC600 Option Specifications.....	8-5
8-3.	Volt Specifications .....	8-6
8-4.	Edge Specifications .....	8-7
8-5.	Leveled Sine Wave Specifications .....	8-8
8-6.	Time Marker Specifications .....	8-9
8-7.	Wave Generator Specifications .....	8-9
8-8.	Pulse Generator Specifications.....	8-10
8-9.	Trigger Signal Specifications (Pulse Function) .....	8-11
8-10.	Trigger Signal Specifications (Time Marker Function).....	8-11
8-11.	Trigger Signal Specifications (Edge Function).....	8-11
8-12.	Trigger Signal Specifications (Square Wave Voltage Function).....	8-11
8-13.	Trigger Signal Specifications .....	8-11
8-14.	Oscilloscope Input Resistance Measurement Specifications .....	8-12
8-15.	Oscilloscope Input Capacitance Measurement Specifications.....	8-12
8-16.	Overload Measurement Specifications.....	8-12
8-17.	Oscilloscope Connections.....	8-13
8-18.	Starting the SC600 Option.....	8-13
8-19.	The Output Signal .....	8-14
8-20.	Adjusting the Output Signal .....	8-14
8-21.	Keying in a Value .....	8-14
8-22.	Adjusting Values with the Rotary Knob.....	8-15
8-23.	Using $\boxed{\text{MULT}}$ and $\boxed{\text{DIV}}$ .....	8-15
8-24.	Resetting the SC600 Option .....	8-15
8-25.	Calibrating the Voltage Amplitude on an Oscilloscope .....	8-16
8-26.	The VOLT Function.....	8-16
8-27.	The V/DIV Menu .....	8-17
8-28.	Shortcuts for Setting the Voltage Amplitude.....	8-17
8-29.	Oscilloscope Amplitude Calibration Procedure.....	8-18
8-30.	Calibrating the Pulse and Frequency Response on an Oscilloscope ....	8-19
8-31.	The Edge Function .....	8-19
8-32.	Oscilloscope Pulse Response Calibration Procedure .....	8-20
8-33.	Pulse Response Calibration Using a Tunnel Diode Pulser .....	8-21
8-34.	The Leveled Sine Wave Function .....	8-21
8-35.	Shortcuts for Setting the Frequency and Voltage.....	8-22

8-36.	The MORE OPTIONS Menu .....	8-23
8-37.	Sweeping Through a Frequency Range.....	8-24
8-38.	Oscilloscope Frequency Response Calibration Procedure.....	8-24
8-39.	Calibrating the Time Base of an Oscilloscope .....	8-26
8-40.	The Time Marker Function .....	8-26
8-41.	Time Base Marker Calibration Procedure for an Oscilloscope .....	8-27
8-42.	Testing the Trigger .....	8-28
8-43.	Testing Video Triggers .....	8-30
8-44.	Verifying Pulse Capture .....	8-31
8-45.	Measuring Input Resistance and Capacitance .....	8-32
8-46.	Input Impedance Measurement .....	8-32
8-47.	Input Capacitance Measurement .....	8-33
8-48.	Testing Overload Protection .....	8-33
8-49.	Remote Commands and Queries.....	8-34
8-50.	General Commands .....	8-35
8-51.	Edge Function Commands.....	8-38
8-52.	Marker Function Commands .....	8-38
8-53.	Video Function Commands .....	8-38
8-54.	Overload Function Commands .....	8-39
8-55.	Impedance/Capacitance Function Commands.....	8-40
8-56.	Verification Tables .....	8-41
8-57.	DC Voltage Verification .....	8-41
8-58.	AC Voltage Amplitude Verification .....	8-42
8-59.	AC Voltage Frequency Verification .....	8-42
8-60.	Wave Generator Amplitude Verification: 1 M $\Omega$ Output Impedance.....	8-43
8-61.	Wave Generator Amplitude Verification: 50 $\Omega$ Output Impedance .	8-44
8-62.	Leveled Sinewave Verification: Amplitude .....	8-45
8-63.	Leveled Sinewave Verification: Frequency .....	8-45
8-64.	Leveled Sinewave Verification: Harmonics.....	8-46
8-65.	Leveled Sinewave Verification: Flatness.....	8-47
8-66.	Edge Verification: Amplitude .....	8-53
8-67.	Edge Verification: Frequency .....	8-53
8-68.	Edge Verification: Duty Cycle .....	8-53
8-69.	Edge Verification: Rise Time.....	8-54
8-70.	Tunnel Diode Pulser Verification .....	8-54
8-71.	Marker Generator Verification.....	8-55
8-72.	Pulse Generator Verification: Period .....	8-55
8-73.	Pulse Generator Verification: Pulse Width .....	8-55
8-74.	Input Impedance Verification: Resistance .....	8-56
8-75.	Input Impedance Verification: Capacitance .....	8-56

## 8-1. Introduction

The SC600 Option provides functions that help you maintain your oscilloscope's accuracy by verifying and calibrating the following oscilloscope characteristics:

- Vertical deflection characteristics are calibrated and verified. The VOLT function lets you compare the voltage gain to the graticule lines on the oscilloscope.
- Pulse transient response is checked and calibrated, verifying the accuracy of the oscilloscope's measurement of pulse transitions using the EDGE function. Also, the calibrator supports even faster pulse response checks using an external tunnel diode pulser.
- Frequency response is checked by verifying the bandwidth using the Leveled Sine Wave (LEVSINE) function. Vertical deflection is monitored until the -3 dB point is observed on the oscilloscope.
- Horizontal (time base) deflection characteristics are calibrated and verified using the Time MARKER function. This calibration procedure is similar to the one for verifying the vertical deflection characteristics, except that it checks the horizontal axis.
- The oscilloscope's ability to display, capture, and measure pulse width is checked using the PULSE function. This function allows you to vary both the pulse width and the period.
- The oscilloscope's ability to trigger on different waveforms is checked using the Wave Generator (WAVEGEN) function.
- The oscilloscope's ability to trigger on and capture complex TV Trigger signals is checked using the VIDEO function.
- The oscilloscope's input characteristics can be measured using the Input Resistance and Capacitance (MEAS Z) function.
- The oscilloscope's input protection circuit can be tested using the Overload (OVERLD) function.

The menus that implement these functions also include parameters for altering the way the output signal responds to voltage, frequency, and time settings, giving you control of the signal during calibration, and providing more methods for observing the signal's characteristics.

## 8-2. SC600 Option Specifications

These specifications apply only to the SC600 Option. General specifications that apply to the 5520A (hereafter termed the Calibrator) can be found in Chapter 1. The specifications are valid under the following conditions:

- The Calibrator is operated under the conditions specified in Chapter 1.
- The Calibrator has completed a warm-up period of at least twice the length of time the calibrator was powered off, up to a maximum of 30 minutes.
- The 5500A-SC600 Option has been active longer than 5 minutes.

### 8-3. Volt Specifications

Table 8-1. Volt Specifications

	Volt Function			
	dc Signal		Square Wave Signal [1]	
	50 $\Omega$ Load	1 M $\Omega$ Load	50 $\Omega$ Load	1 M $\Omega$ Load
<b>Amplitude Characteristics</b>				
Range	0 V to $\pm 6.6$ V	0 V to $\pm 130$ V	$\pm 1$ mV to $\pm 6.6$ V p-p	$\pm 1$ mV to $\pm 130$ V p-p
Resolution	Range 1 mV to 24.999 mV 25 mV to 109.99 mV 110 mV to 2.1999 V 2.2 V to 10.999 V 11 V to 130 V		Resolution 1 $\mu$ V 10 $\mu$ V 100 $\mu$ V 1 mV 10 mV	
Adjustment Range	Continuously adjustable			
1-Year Absolute Uncertainty, tcal $\pm 5$ $^{\circ}$ C	$\pm (0.25\%$ of output + 40 $\mu$ V)	$\pm (0.05\%$ of output + 40 $\mu$ V)	$\pm (0.25\%$ of output + 40 $\mu$ V)	$\pm (0.1\%$ of output + 40 $\mu$ V) [2]
Sequence	1-2-5 (e.g., 10 mV, 20 mV, 50 mV)			
<b>Square Wave Frequency Characteristics</b>				
Range	10 Hz to 10 kHz			
1-Year Absolute Uncertainty, tcal $\pm 5$ $^{\circ}$ C	$\pm (2.5$ ppm of setting)			
<b>Typical Aberration</b> within 4 $\mu$ s from 50% of leading/trailing edge	< (0.5% of output + 100 $\mu$ V)			
[1] Selectable positive or negative, zero referenced square wave.				
[2] For square wave frequencies above 1 kHz, $\pm (0.25\%$ of output + 40 $\mu$ V).				

**8-4. Edge Specifications**

**Table 8-2. Edge Specifications**

Edge Characteristics into 50Ω Load		1-Year Absolute Uncertainty, tcal ± 5 °C
Rise Time	≤ 300 ps	(+0 ps / -100 ps)
Amplitude Range (p-p)	5.0 mV to 2.5 V	± (2% of output + 200 μV)
Resolution	4 digits	
Adjustment Range	± 10% around each sequence value (indicated below)	
Sequence Values	5 mV, 10 mV, 25 mV, 50 mV, 60 mV, 80 mV, 100 mV, 200 mV, 250 mV, 300 mV, 500 mV, 600 mV, 1 V, 2.5 V	
Frequency Range	1 kHz to 2 MHz [1]	± (2.5 ppm of setting)
Typical Jitter, edge to trigger	< 5 ps (p-p)	
Leading Edge Aberrations [2]	within 2 ns from 50% of rising edge	< (3% of output + 2 mV)
	2 to 5 ns	< (2% of output + 2 mV)
	5 to 15 ns	< (1% of output + 2 mV)
	after 15 ns	< (0.5% of output + 2 mV)
Typical Duty Cycle	45% to 55%	
Tunnel Diode Pulse Drive	Square wave at 100 Hz to 100 kHz, with variable amplitude of 60 V to 100V p-p.	
[1] The Frequency Range extends to 10 MHz with the Rise Time specification increased to ≤ 350 ps. [2] All edge aberration measurements are made with a Tektronix 11801 mainframe with an SD26 input module.		

## 8-5. Leveled Sine Wave Specifications

Table 8-3. Leveled Sine Wave Specifications

Leveled Sine Wave Characteristics into 50 $\Omega$	Frequency Range			
	50 kHz (reference)	50 kHz to 100 MHz	100 MHz to 300 MHz	300 MHz to 600 MHz
<b>Amplitude Characteristics (for measuring oscilloscope bandwidth)</b>				
Range (p-p)	5 mV to 5.5 V			
Resolution	< 100 mV: 3 digits ≥ 100 mV: 4 digits			
Adjustment Range	continuously adjustable			
1-Year Absolute Uncertainty, tcal $\pm$ 5 °C	$\pm$ (2% of output + 300 $\mu$ V)	$\pm$ (3.5% of output + 300 $\mu$ V)	$\pm$ (4% of output + 300 $\mu$ V)	$\pm$ (6% of output + 300 $\mu$ V)
Flatness (relative to 50 kHz)	not applicable	$\pm$ (1.5% of output + 100 $\mu$ V)	$\pm$ (2% of output + 100 $\mu$ V)	$\pm$ (4% of output + 100 $\mu$ V)
Short-Term Amplitude Stability	$\leq$ 1% [1]			
<b>Frequency Characteristics</b>				
Resolution	10 kHz			
1-Year Absolute Uncertainty, tcal $\pm$ 5 °C	$\pm$ 2.5 ppm			
<b>Distortion Characteristics</b>				
2nd Harmonic	$\leq$ -33 dBc			
3rd and Higher Harmonics	$\leq$ -38 dBc			
[1] Within one hour after reference amplitude setting, provided temperature varies no more than $\pm$ 5°C.				



## 8-6. Time Marker Specifications

**Table 8-4. Time Marker Specifications**

Time Maker into 50 Ω	5 s to 50 ms	20 ms to 100 ns	50 ns to 20 ns	10 ns	5 ns to 2 ns
1-Year Absolute Uncertainty at Cardinal Points, tcal ±5 ° C [3]	±(25 + t *1000) ppm [1]	± 2.5 ppm	± 2.5 ppm	± 2.5 ppm	± 2.5 ppm
Wave Shape	spike or square	spike, square, or 20%-pulse	spike or square	square or sine	sine
Typical Output Level	> 1 V p-p [2]	> 1 V p-p [2]	> 1 V p-p [2]	> 1 V p-p [2]	> 1 V p-p
Typical Jitter (rms)	<10 ppm	< 1 ppm	< 1 ppm	< 1 ppm	< 1 ppm
Sequence (cardinal points)	5-2-1 from 5 s to 2 ns (e.g., 500 ms, 200 ms, 100 ms)				
Adjustment Range	At least ± 10% around each cardinal point.				
Amplitude Resolution	4 digits				
<p>[1] t is the time in seconds. Examples: At 5 s the uncertainty is 5,025 ppm; At 50 ms the uncertainty is 75 ppm.</p> <p>[2] Typical rise time of square wave and 20%-pulse (20% duty cycle pulse) is &lt; 1.5 ns.</p> <p>[3] Away from the cardinal points, add ±50 ppm to uncertainty.</p>					

## 8-7. Wave Generator Specifications

**Table 8-5. Wave Generator Specifications**

Wave Generator Characteristics	Square Wave, Sine Wave, and Triangle Wave into 50 Ω or 1 MΩ
<b>Amplitude</b>	
Range	into 1 MΩ: 1.8 mV to 55 V p-p into 50 Ω: 1.8 mV to 2.5 V p-p
1-Year Absolute Uncertainty, tcal ± 5 °C, 10 Hz to 10 kHz	± (3% of p-p output + 100 μV)
Sequence	1-2-5 (e.g., 10 mV, 20 mV, 50 mV)
Typical DC Offset Range	0 to ± (≥40% of p-p amplitude) [1]
<b>Frequency</b>	
Range	10 Hz to 100 kHz
Resolution	4 or 5 digits depending upon frequency
1-Year Absolute Uncertainty, tcal ± 5 °C	± (25 ppm + 15 mHz)
[1] The DC offset plus the wave signal must not exceed 30 V rms.	

## 8-8. Pulse Generator Specifications

Table 8-6. Pulse Generator Specifications

Pulse Generator Characteristics	Positive pulse into 50 $\Omega$
Typical rise/fall times	1 ns
Available Amplitudes	2.5 V, 1 V, 250 mV, 100 mV, 25 mV, 10 mV
<b>Pulse Width</b>	
Range	4 ns to 500 ns <sup>[1]</sup>
Uncertainty <sup>[2]</sup>	5% $\pm$ 2 ns
<b>Pulse Period</b>	
Range	20 ms to 200 ns (50 Hz to 5 MHz)
Resolution	4 or 5 digits depending upon frequency and width
1-Year Absolute Uncertainty at Cardinal Points, tcal $\pm$ 5 $^{\circ}$ C	$\pm$ 2.5 ppm
[1] Pulse width not to exceed 40% of period.	
[2] Pulse width uncertainties for periods below 2 ms are not specified.	

### 8-9. Trigger Signal Specifications (Pulse Function)

Table 8-7. Trigger Signal Specifications (Pulse Function)

Time Marker Period	Division Ratio [1]	Amplitude into 50 Ω (p-p)	Typical Rise Time
20 ms to 150 ns	off/1/10/100	≥ 1 V	≤ 2 ns

### 8-10. Trigger Signal Specifications (Time Marker Function)

Table 8-8. Trigger Signal Specifications (Time Marker Function)

Pulse Period	Division Ratio [1]	Amplitude into 50 Ω (p-p)	Typical Rise Time
5 s to 750 ns	off/1	≥ 1 V	≤ 2 ns
34.9 ms to 7.5 ns	off/10	≥ 1 V	≤ 2 ns
34.9 ms to 2 ns	off/100	≥ 1 V	≤ 2 ns

### 8-11. Trigger Signal Specifications (Edge Function)

Table 8-9. Trigger Signal Specifications (Edge Function)

Edge Signal Frequency	Division Ratio	Typical Amplitude into 50 Ω (p-p)	Typical Rise Time	Typical Lead Time
1 kHz to 10 MHz	off/1	≥ 1 V	≤ 2 ns	40 ns

### 8-12. Trigger Signal Specifications (Square Wave Voltage Function)

Table 8-10. Trigger Signal Specifications (Square Wave Voltage Function)

Edge Signal Frequency	Division Ratio	Typical Amplitude into 50 Ω (p-p)	Typical Rise Time	Typical Lead Time
10 Hz to 10 kHz	off/1	≥ 1 V	≤ 2 ns	1 μs

### 8-13. Trigger Signal Specifications

Table 8-11. TV Trigger Signal Specifications

Trigger Signal Type	Parameters
Field Formats	Selectable NTSC, SECAM, PAL, PAL-M
Polarity	Selectable inverted or uninverted video
Amplitude into 50 Ω (p-p)	Adjustable 0 to 1.5 V p-p into 50 Ω load, (±7% accuracy)
Line Marker	Selectable Line Video Marker

### 8-14. Oscilloscope Input Resistance Measurement Specifications

Table 8-12. Oscilloscope Input Resistance Measurement Specifications

Scope input selected	50 $\Omega$	1 M $\Omega$
Measurement Range	40 $\Omega$ to 60 $\Omega$	500 k $\Omega$ to 1.5 M $\Omega$
Uncertainty	0.1 %	0.1 %

### 8-15. Oscilloscope Input Capacitance Measurement Specifications

Table 8-13. Oscilloscope Input Capacitance Measurement Specifications

Scope input selected	1 M $\Omega$
Measurement Range	5 pF to 50 pF
Uncertainty	$\pm$ (5% of input + 0.5 pF) [1]
[1] Measurement made within 30 minutes of capacitance zero reference. Scope option must be selected for at least five minutes prior to any capacitance measurement, including the zero process.	

### 8-16. Overload Measurement Specifications

Table 8-14. Overload Measurement Specifications

Source Voltage	Typical 'On' current indication	Typical 'Off' current indication	Maximum Time Limit DC or AC (1 kHz)
5 V to 9 V	100 mA to 180 mA	10 mA	settable 1 s to 60 s

### 8-17. Oscilloscope Connections

Using the cable supplied with the SC600 Option, connect the SCOPE output on the Calibrator to one of the channel connectors on your oscilloscope (see Figure 8-1).

To use the external trigger, connect the TRIG OUT output on the Calibrator to the external trigger connection on your oscilloscope. To use the external trigger and view its signal with the calibration signal, connect the TRIG OUT output to another channel. See your oscilloscope manual for details on connecting and viewing an external trigger.

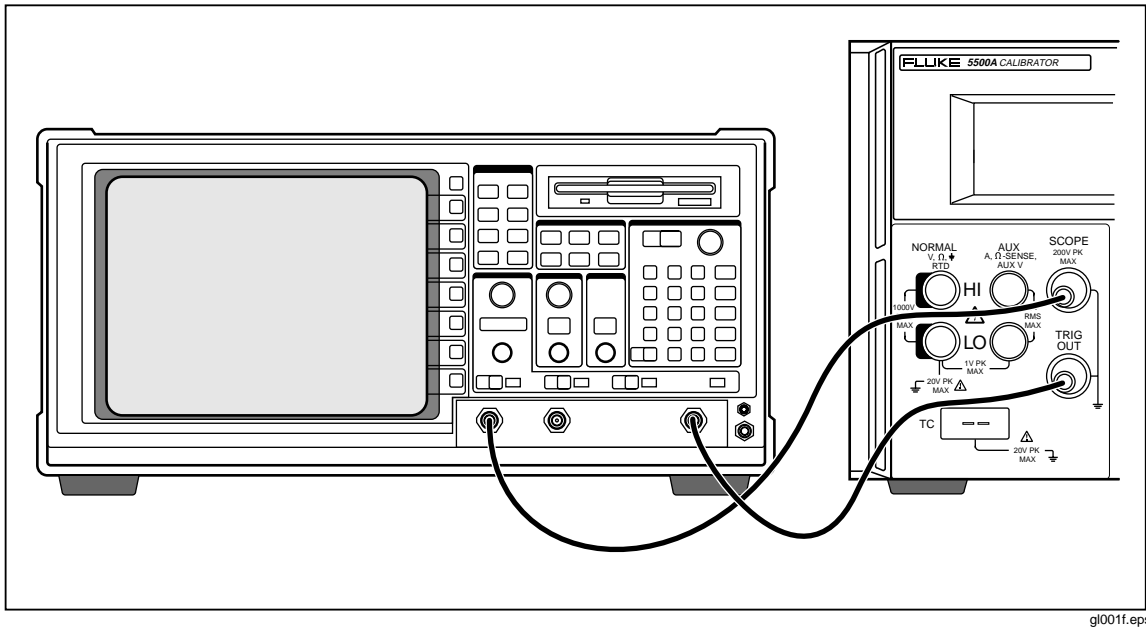
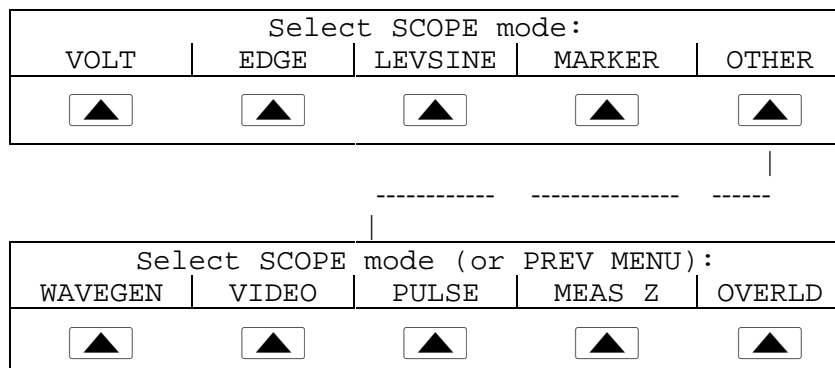

Figure 8-1. Oscilloscope Connection: Channel and External Trigger

### 8-18. Starting the SC600 Option

Press **SCOPE** (LED lit) to select the SC600 Option. The SCOPE menu, shown below, appears in the Control Display. You can press any of the first four softkeys to go directly to the VOLT, EDGE, LEVSINE, and MARKER calibration menus. Press the last softkey to go to the OTHER menu (also shown below), allowing access to WAVEGEN, VIDEO, PULSE, Impedance/Capacitance measurement (MEAS Z), and Overload (OVERLD) menus. Press **PREV MENU** to return to the SCOPE menu from the OTHER menu. This chapter describes each of these menus in detail.



### 8-19. The Output Signal

The following description assumes that you have selected VOLT mode from the SCOPE menu. The Control Displays appears as follows with VOLT mode selected:

Output @ SCOPE.	TRIG	V/DIV	MODE
1 MΩ   DC<-AC	off	MENU	volt

The location of the output signal is indicated on the Control Display (the display on the right side). If your Calibrator is connected, but the output does not appear on the oscilloscope, you may have the Calibrator in standby mode. The settings for the output signal are indicated in the Output Display (the display on the left side).

If STBY is displayed, press the key. The Output Display will show OPR and the output should appear on the oscilloscope.

### 8-20. Adjusting the Output Signal

The Calibrator provides several ways to change the settings for the output signal during calibration. Since oscilloscope calibration requires many adjustments of the output signal, the three available methods for changing these settings for oscilloscope calibration are summarized below. These methods provide the means of jumping to a new value or sweeping through a range of values.

### 8-21. Keying in a Value

The following example is for use in the LEVSINE mode. To key a specific value directly into the Calibrator from its front panel:

1. Key in the value you want to enter, including the units and prefixes. For example to enter 120 mV press . The Control Display will show:

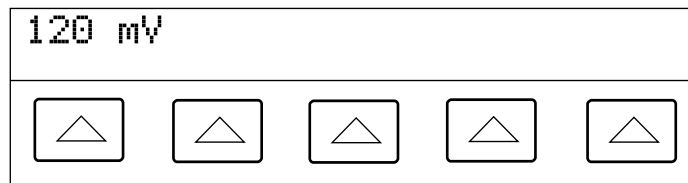

g1002i.eps

#### Note

Units and prefixes printed in red in the upper left corner of the keys are accessed through the key. For example, to enter 200 μs, press

.

If you make an error, press to clear the Control Display and return to the menu.

2. Press to activate the value and move it to the Output Display.

Other settings in the display will remain unaltered unless you key in an entry and specify the units for that setting.

### 8-22. Adjusting Values with the Rotary Knob

To adjust values in the Output Display using the rotary knob:

1. Turn the rotary knob. A cursor appears in the Output Display under the lowest digit and begins changing that digit. If you wish to place the cursor in the field without changing the digit, press **EDIT FIELD**.

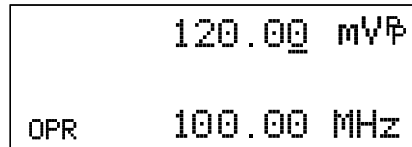

gl003i.eps

2. To move the cursor between the voltage and frequency fields, press **EDIT FIELD**.

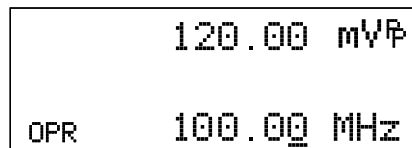

gl004i.eps

3. Use the **◀** and **▶** keys to move the cursor to the digit you want to change.
4. Turn the rotary knob to change the value.

When you use the rotary knob in either VOLT mode or MARKER mode, the Control Display shows the new value's percentage change from the reference value. This is useful for determining the percentage of error on the oscilloscope. You can set the reference value to the new value by pressing **NEW REF**.

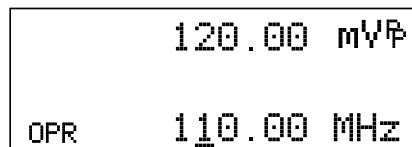

gl005i.eps

5. Press **ENTER** to remove the cursor from the Output Display and save the new value as the reference value.

#### Note

*If you attempt to use the rotary knob to adjust a value to an amount that is invalid for the function you are using, or is outside the value's range limit, the value will not change and the Calibrator will beep.*

### 8-23. Using **MULT X** and **DIV**

The **MULT X** and **DIV** keys cause the current value of the signal to jump to a pre-determined cardinal value, whose amount is determined by the current function. These keys are described in more detail under the descriptions for each function.

### 8-24. Resetting the SC600 Option

You can reset all parameters in the Calibrator to their default settings at any time during front panel operations by pressing the **RESET** key on the front panel.

After resetting the Calibrator, press **SCOPE** to return to the SC600 Option (the SCOPE menu appears.) Press **OPR** to reconnect the signal output.

## 8-25. Calibrating the Voltage Amplitude on an Oscilloscope

The oscilloscope voltage (vertical) gain is calibrated by applying a dc or low frequency square wave signal and adjusting its gain to meet the height specified for different voltage levels, as designated by the graticule line divisions on the oscilloscope. The signal is applied from the Calibrator in VOLT mode. The specific voltages that you should use for calibration, and the graticule line divisions that need to be matched, vary for different oscilloscopes and are specified in your oscilloscope's service manual.

### 8-26. The VOLT Function

You can calibrate the Voltage gain using the VOLT function. Access this function through the VOLT menu, which appears when you press **SCOPE**, or when you press the VOLT softkey from the SCOPE menu.

Output @ SCOPE.	TRIG	V/DIV	MODE
1 MΩ	DC<-AC	off	MENU
1 MΩ 50Ω	DC<-AC DC->AC	off /1	(see "The V/DIV Menu")
			volt edge levsine marker wavegen video pulse meas Z overld

You can press the MODE softkey to cycle through the functions in the order shown, or you can press **PREV MENU** to return directly to the SCOPE menu.

Each menu item is described below:

- **OUTPUT @ SCOPE** Indicates the location of the signal output. If the signal does not appear on the oscilloscope, press **OPR**. To disconnect the signal, press **STBY**.
- **1 MΩ** Toggles between 1 MΩ and 50 Ω to match the input impedance of the oscilloscope.
- **DC<-AC** toggles from ac to dc, producing the dc equivalent output. **DC->AC** Toggles from dc to ac.
- **TRIG** If you are using square wave to calibrate the external trigger, use this key to toggle the trigger off and on. When on, the reading will show "/1", which indicates that the external trigger is at the same frequency as the volt output. The external trigger can be useful for many oscilloscopes that have difficulty triggering on low amplitude signals. You can also toggle the trigger off and on by pressing **TRIG OUT**.
- **V/DIV MENU** Opens the voltage scaling menu, which lets you select the scale of the signal in volts per division. This menu is described below in detail, under "The V/DIV Menu."
- **MODE** Indicates you are in VOLT mode. Use the softkey to change modes and open menus for other oscilloscope calibration modes.



### 8-27. The V/DIV Menu

The V/DIV menu, shown below, sets the number of volts denoted by each division on the oscilloscope. This menu provides alternative methods for changing the output amplitude that may be more convenient for certain oscilloscope applications. To access the V/DIV menu, press V/DIV from the VOLT menu.

20.00 mV/div		#DIV = 1		MODE
up	down	up	down	volt
▲	▲	▲	▲	▲
-----		-----		<b>volt</b>
1 mV	0.5V	<b>1</b>		edge
2 mV	1V	2		levsine
5 mV	2V	3		marker
10 mV	5V	4		wavegen
<b>20 mV</b>	10V	5		video
50 mV	20V	6		pulse
100 mV	50V	7		meas Z
200 mV	100V	8		overld

Each item in the V/DIV menu is described below:

- **V/div** Changes the number of volts per division in the Output Display so that the values selected correspond to the oscilloscope's input sensitivity (VOLTS/DIV.) The available settings, shown in the figure above, are provided in 1-2-5 step increments. Press the softkey under UP to increase the volts per division. Press the softkey under DOWN to decrease the volts per division.
- **#DIV** Specifies the number of divisions that establish the peak-to-peak value of the waveform. The value can be adjusted from one to eight divisions. The amount denoted by each division is displayed in the V/div field. Press the softkey under UP to increase the signal's height, and press the softkey under DOWN to decrease it.

### 8-28. Shortcuts for Setting the Voltage Amplitude

The **MULT** and **DIV** keys step the voltages through cardinal point values of an oscilloscope in a 1-2-5 step sequence. For example, if the voltage is 40 mV, pressing **MULT** increases the voltage to the nearest cardinal point, which is 50 mV. Pressing **DIV** decreases the voltage to the nearest cardinal point, which is 20 mV.

### 8-29. Oscilloscope Amplitude Calibration Procedure

The following example describes how to use the VOLT menu to calibrate the oscilloscope's amplitude gain. During calibration, you will need to set different voltages and verify that the gain matches the graticule lines on the oscilloscope according to the specifications for your particular oscilloscope. See your oscilloscope manual for the recommended calibration settings and appropriate gain values.

Before you start this procedure, verify that you are running the SC600 Option in VOLT mode. If you are, the Control Display shows the following menu.

Output @ SCOPE. 1 MΩ	DC<-AC	TRIG off	V/DIV MENU	MODE volt
▲	▲	▲	▲	▲

Perform the following sample procedure to calibrate the vertical gain:

1. Connect the calibrator to Channel 1 on the oscilloscope, making sure the oscilloscope is terminated at the proper impedance (1 MΩ for this example). Verify that the **OPR** key on the Calibrator is lit, indicating that the signal is connected.
2. Key in the voltage level that is recommended for your oscilloscope. For example to enter 20 mV, press **2** **0** **μmV**, then press **ENTER**. See "Keying in a Value" earlier in this chapter.
3. Adjust the oscilloscope as necessary. The waveform should be similar to the one shown below, with the gain at exactly the amount specified for the calibration settings for your oscilloscope. This example shows the gain at 20 mV to be 4 divisions, at 5 mV per division.

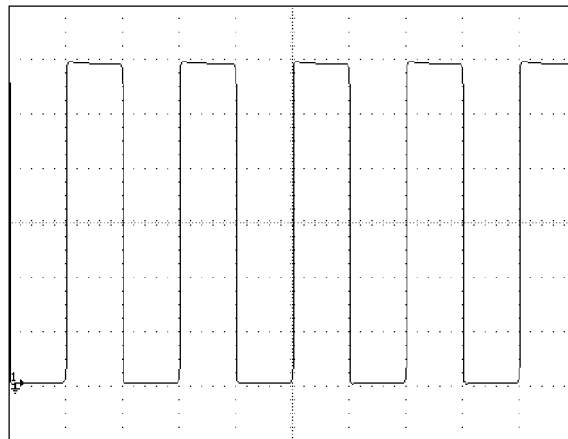

gl006i.eps

4. Change the voltage to the next value recommended for calibrating your oscilloscope model, and repeat this procedure at the new voltage level, verifying the gain is correct according to the specifications in your manual.
5. Repeat the procedure for each channel.

## 8-30. Calibrating the Pulse and Frequency Response on an Oscilloscope

The pulse response is calibrated with a square-wave signal that has a fast leading edge rise-time. Using this signal, you adjust the oscilloscope as necessary until it meets its particular specifications for rise time and pulse aberrations.

Following pulse verification, the frequency response is checked by applying a leveled sine wave and acquiring a frequency reading at the -3 dB point, when the amplitude drops approximately 30%.

### 8-31. The Edge Function

The EDGE function is used for calibrating the pulse response for your oscilloscope. To reach the EDGE menu, press the softkey under MODE until “edge” appears.

Output at SCOPE terminal (50Ω).	TDPULSE off	TRIG off	MODE edge
	off on	off /1	volt <b>edge</b> levsine marker wavegen video pulse meas Z overld

You can press the MODE softkey to cycle through the functions in the order shown, or you can press **PREV MENU** to return directly to the SCOPE menu.

Each option in the EDGE menu is described below:

- **OUTPUT @ SCOPE terminal (50 Ω)** Indicates the location and impedance of the signal output. If the signal does not appear on the oscilloscope, press **OPR**. To disconnect the signal, press **STBY**.
- **TD PULSE** Press once to turn the Tunnel Diode Pulser drive signal on, again to turn the Pulser drive off. This signal sources up to 100 V p/p to drive a Tunnel Diode Pulser (Fluke Part Number 606522, Tektronix 067-0681-01, or equivalent.)
- **TRIG** If you are using the external trigger, use this key to toggle the trigger off and on. When on, the reading will show “/1” which indicates that the external trigger is at the same frequency as the edge output. The external trigger can be useful for many oscilloscopes that have difficulty triggering on low amplitude signals.

You can also toggle the trigger off and on by pressing **TRIG OUT**.

- **MODE** Indicates you are in EDGE mode. Use the softkey to change modes and open menus for other oscilloscope calibration modes.

### 8-32. Oscilloscope Pulse Response Calibration Procedure

This sample procedure shows how to check the oscilloscope's pulse response. Before you check your oscilloscope, see your oscilloscope's manual for the recommended calibration settings.

Before you start this procedure, verify that you are running the SC600 Option in EDGE mode. If you are, the Control Display shows the following menu.

Output at SCOPE terminal (50Ω).	TDPULSE off	TRIG off	MODE edge
▲	▲	▲	▲

Perform the following sample procedure to calibrate the pulse response:

1. Connect the Calibrator to Channel 1 on the oscilloscope. Select 50 Ω impedance or use a 50 Ω termination directly at the oscilloscope input. Verify that the **OPR** key is lit, indicating that the signal is connected.
2. Alter the voltage setting for the signal so it matches the amplitude value recommended by your oscilloscope manufacturer for calibrating the edge response. The default setting is 25.00 mV p/p, 1.0000 MHz.

For example, on an HP 54522C oscilloscope, start with a signal of 1 V @ 1 MHz.

3. Adjust the scale on your oscilloscope to achieve a good picture of the edge.
4. Adjust the time base on your oscilloscope to the fastest position available (20.0 or 50.0 ns/div).

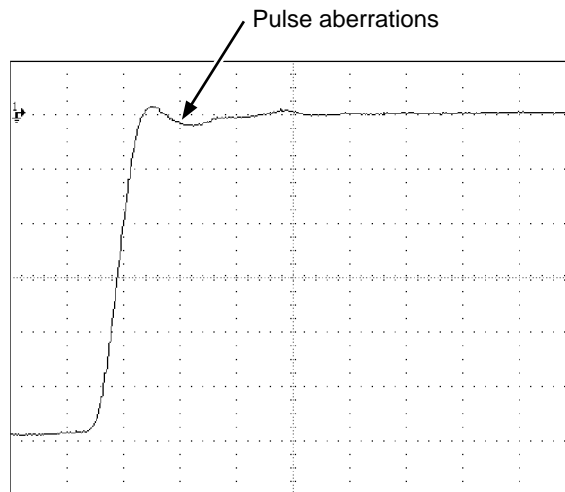

5. Verify that your oscilloscope exhibits the proper rise time and pulse aberration characteristics.
6. Remove the input signal by pressing **STBY**.

gl007i.eps

**8-33. Pulse Response Calibration Using a Tunnel Diode Pulser**

You can use the calibrator to drive a tunnel diode pulser (Fluke Part Number 606522, or Tektronix 067-0681-01, or equivalent), allowing you to check for pulse edge rise times as fast as 125 ps.

The calibrator sources a maximum pulser drive signal of 100 V p/p at 100 kHz. The recommended (and default) output setting is 80 V p/p at 100 kHz.

Perform the following procedure to use a tunnel diode pulser:

1. Connect the calibrator, tunnel diode pulser, and oscilloscope as shown in Figure 8-2.
2. With the SC600 Option in EDGE mode, press the TDPULSE softkey to “on”.
3. Press **OPR**.
4. Rotate the control on the pulser box to the minimum setting necessary to trigger a reading.

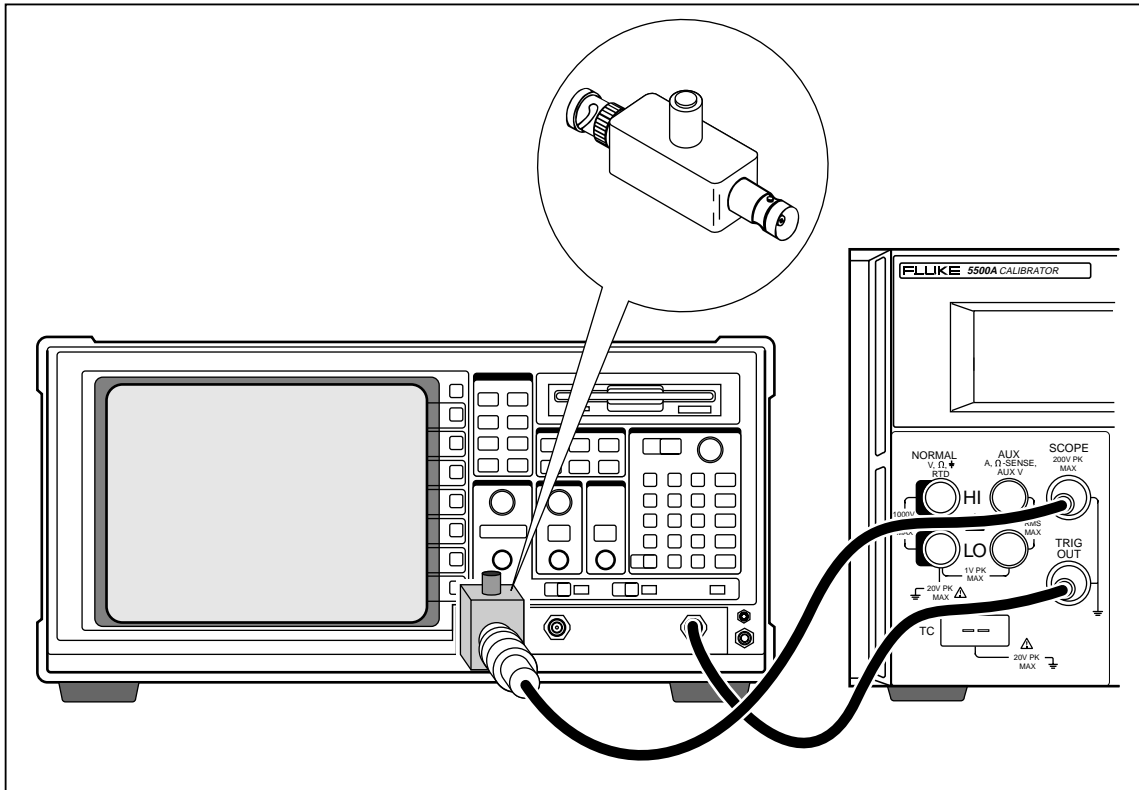

Figure 8-2. Tunnel Diode Pulser Connections

gl008f.eps

**8-34. The Leveled Sine Wave Function**

The Leveled Sine Wave (LEVSINE) function uses a leveled sine wave, whose amplitude remains relatively constant over a range of frequencies, to check the oscilloscope’s bandwidth. When you check your oscilloscope, you change the wave’s frequency until the amplitude displayed on the oscilloscope drops 30%, which is the amplitude that corresponds to the -3 dB point. Default values are 30 mV p/p, 50 kHz.

To access the LEVSINE menu, press the softkey under MODE until “levsine” appears.

Output @ SCOPE terminal (50Ω).	MORE OPTIONS	SET TO LAST F	MODE levsine
▲	▲	▲	▲
	(see “The MORE OPTIONS Menu” )	<b>LAST F</b> 50 kHz	volt edge <b>levsine</b> marker wavegen video pulse meas Z overld

You can press the MODE softkey to cycle through the functions in the order shown, or you can press **PREV MENU** to return directly to the SCOPE menu.

Each option in the LEVSINE menu is described below:

- **OUTPUT @ SCOPE terminal (50 Ω)** Indicates the location and impedance of the signal output. If the signal does not appear on the oscilloscope, press **OPR**. To disconnect the signal, press **STBY**. You cannot change the impedance while you are in LEVSINE mode.
- **MORE OPTIONS** Opens additional menu items, which are described in detail under “The MORE OPTIONS Menu.”
- **SET TO LAST F** Toggles between the current frequency setting and the reference value of 50 kHz. This option is useful for reverting to the reference to check the output after you make adjustments at another frequency.
- **MODE** Indicates you are in LEVSINE mode. Use the softkey to change modes and open menus for other calibration modes.

### 8-35. Shortcuts for Setting the Frequency and Voltage

The following three options are available for controlling the sine wave settings:

- **SET TO LAST F** toggles between the last frequency used and the reference frequency of 50 kHz, letting you check the output at the reference after you make adjustments at a different frequency.
- **MORE OPTIONS** lets you use an automatic frequency sweep and lock the voltage range, if necessary. The following section provides details on this menu.
- The **MULT X** and **DIV** keys step frequencies up or down in amounts that let you quickly access a new set of frequencies. For example, if the value is 250 kHz, **MULT X** changes it to 300 kHz, and **DIV** changes it to 200 kHz. For voltage values, **MULT X** and **DIV** step through cardinal point values in a 1.2-3-6 sequence.

**8-36. The MORE OPTIONS Menu**

When you select MORE OPTIONS, you open options that give you more control over the frequency and voltage. To access the MORE OPTIONS menu, press the softkey under MORE OPTIONS in the LEVSINE menu.

FREQ CHG	RATE	Range = 40 mV	MODE
jump	1 MHz	auto	levsine
jump	1 MHz	-----	volt
sweep	10 MHz	auto	edge
	100 kHz	locked	levsine
		10 mV	marker
		<b>40 mV</b>	wavegen
		100 mV	video
		400 mV	pulse
		1.3V	meas Z
		5.5V	overld

Each option in the MORE OPTIONS menu is described below:

- FREQ CHG** Toggles between two settings that control the way the output signal adjusts to a new frequency. “Jump” is the default setting.

“Jump” causes the output signal to jump immediately to a new frequency setting. “Sweep” causes the signal to sweep through a series of frequency values, over a range you set. Use the sweep function to watch the signal gradually change over a given bandwidth and see the point at which its amplitude changes. Details for using the sweep function are provided under “Sweeping Through a Frequency Range.”
- RATE** Used when FREQ CHANGE is set to “sweep” to select a sweep speed of 100 kHz, 1 MHz, or 10 MHz.

A slower sweep rate lets you watch the frequency change very slowly. After a faster sweep, you may want to pinpoint a certain frequency with a slower sweep over a subset of your previous frequency range.
- RANGE** The softkeys toggle between two settings. The first setting (“auto”) changes the range limit automatically in accordance with the voltage level. The second setting (“locked”) freezes the present range limit; subsequent changes in voltage level are then measured with this range limit.

There are six range limits in LEVSINE mode: 10 mV, 40 mV, 100 mV, 400 mV, 1.3 V, and 5.5 V. When set to “auto” the calibrator uses your voltage setting to automatically set the range limit that provides the most accurate output.

When set to “locked” the range limit remains fixed and you can decrease the voltage down to the bottom of the range.

For example, assume the range limit is 40 mV. If you enter 5 mV with “auto” selected, the calibrator will automatically change the range limit to 10 mV and output 5 mV from within the 10 mV range. However, if you start with the 40 mV range “locked” and then enter 5 mV, the calibrator will output 5 mV from within the 40 mV range.

The default range setting is “auto,” which should always be used unless you are troubleshooting discontinuities in your oscilloscope’s vertical gain. The range setting will always return to “auto” after you leave LEVSINE mode.

- **MODE** Indicates you are in LEVSINE mode. Use the softkey to change modes and open menus for other calibration modes.

### 8-37. Sweeping Through a Frequency Range

When you change frequencies using the sweep method, the output sine wave sweeps through a specified range of frequencies. This feature lets you identify the frequency at which the oscilloscope’s signal exhibits certain behavior; you can quickly see the frequency response of the oscilloscope. Before you start this procedure, make sure you are in the MORE OPTIONS menu and the sine wave is displayed on the oscilloscope.

Perform the following procedure to sweep through frequencies:

1. Make sure the output signal shows the starting frequency. If not, key in the starting frequency; then press **ENTER** .
2. Toggle **FREQ CHANGE** to “sweep.” Toggle the **RATE** to a lower frequency if you want to observe a very slow sweep over a small range.
3. Key in the end frequency; then press **ENTER** . After you press **ENTER** , the signal sweeps through frequencies between the two values you entered, and the Sweep menu (“Sweeping from previous to displayed frequency”) appears on the Control Display.
4. You can let the signal sweep through the entire range, or you can halt the sweep if you need to record the frequency at a certain point.

To interrupt the sweep, press the softkey under **HALT SWEEP**. The current frequency will appear on the Output Display and the MORE OPTIONS menu will reappear on the Control Display.

#### *Note*

*When you interrupt the frequency sweep by pressing HALT SWEEP, the FREQ CHANGE method switches back to “jump.”*

5. Repeat the procedure if necessary. For example, if you did a fast sweep, you may want to pinpoint a certain frequency with a slow sweep over a subset of your previous frequency range.

### 8-38. Oscilloscope Frequency Response Calibration Procedure

This sample procedure, which verifies the frequency response on your oscilloscope, is usually performed after the pulse response is verified.

This procedure checks the bandwidth by finding the frequency at the -3 dB point for your oscilloscope. The reference sine wave in this procedure has an amplitude of 6 divisions, so that the -3 dB point can be found when the amplitude drops to 4.2 divisions.



Before you start this example procedure, verify that you are running the SC600 Option in LEVSINE mode. If you are, the Control Display shows the following menu.

Output @ SCOPE terminal (50Ω)	MORE OPTIONS	SET TO LAST F	MODE levsine
▲	▲	▲	▲

Perform the following sample procedure to calibrate the frequency response:

1. Reconnect the signal by pressing the **OPR** key on the Calibrator. Select 50 Ω impedance or use a 50 Ω external termination directly at the oscilloscope input.
2. Adjust the sine wave settings in the Output Display according to the calibration recommendations in your oscilloscope manual. For example, for the HP 54522C oscilloscope, start at 600 mV @ 1 MHz. To enter 600 mV, press **6** **0** **0** **μm** **dbmV**; then press **ENTER**.
3. Adjust the oscilloscope as necessary. The sine wave should appear at exactly six divisions, peak-to-peak, as shown below.

If necessary, make small adjustments to the voltage amplitude until the wave reaches exactly six divisions. To fine-tune the voltage, press **EDIT FIELD** to bring a cursor into the Output Display, move the cursor with the **◀** key, and turn the rotary knob to adjust the value. (See “Adjusting Values with the Rotary Knob” earlier in this chapter.)

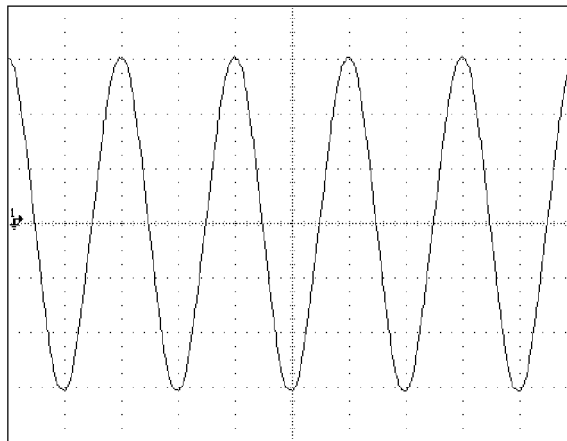

4. Increase the frequency to 400 MHz (for 500-MHz instruments), or 500 MHz (for 600-MHz instruments). To enter 400 MHz, press **4** **0** **0** **P** **M** **Hz**; then press **ENTER**.
5. Continue to increase the frequency slowly until the waveform decreases to 4.2 divisions, as shown below.

To increase the frequency slowly, fine-tune it using the rotary knob. To do this, press **EDIT FIELD** to place a cursor in the Output Display. Press **EDIT FIELD** again to place it in the frequency field, and use the **◀** and **▶** keys to move it to the digit you want to change. Then change the value by turning the rotary knob. Continue making small increments in the frequency until the signal drops to 4.2 divisions. At 4.2 divisions, the signal is at the frequency that corresponds to the -3 dB point.

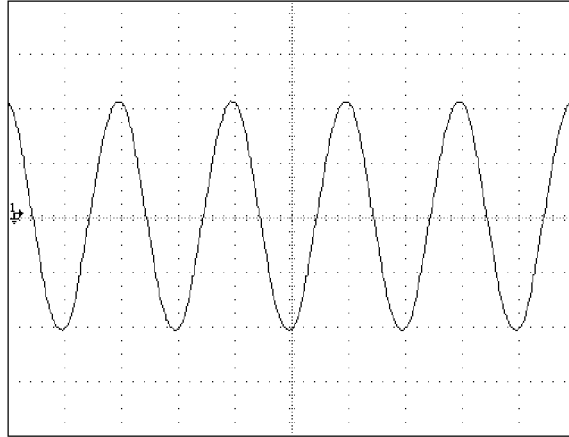

gl010i.eps

6. Remove the input signal by pressing **STBY**.
7. Repeat this procedure for the remaining channels on your oscilloscope.

### 8-39. Calibrating the Time Base of an Oscilloscope

The horizontal deflection (time base) of an oscilloscope is calibrated using a method similar to the vertical gain calibration. A time marker signal is generated from the Calibrator and the signal's peaks are matched to the graticule line divisions on the oscilloscope.

### 8-40. The Time Marker Function

The Time MARKER function, which is available through the MARKER menu, lets you calibrate the timing response of your oscilloscope. To access the MARKER menu, press the softkey under MODE until "marker" appears.

Output at SCOPE terminal (50Ω).	SHAPE	TRIG	MODE
▲	spike	off	marker
▲	sine	off	volt
▲	<b>spike</b>	/1	edge
▲	square	/10	levsine
▲	sq20%	/100	<b>marker</b>
			wavegen
			video
			pulse
			meas Z
			overld

You can press the MODE softkey to cycle through the functions in the order shown, or you can press **PREV MENU** to return directly to the SCOPE menu.

Each option in the MARKER menu is described below:

- **OUTPUT @ SCOPE terminal (50 Ω)** Indicates the location of the signal output. If the signal does not appear on the oscilloscope, press **OPR**. To disconnect the signal, press **STBY**.

- **SHAPE** Indicates the type of waveform. Depending on frequency setting, possible selections are sine, spike, square (50% duty cycle square wave), and sq20% (20% duty cycle square wave.) Note that selections available under SHAPE depend on the selected marker period (frequency), as follows:

Selection	Period (Frequency)
sine	10 ns - 2 ns (100 MHz - 500 MHz)
spike	5 s - 20 ns (0.2 Hz - 50 MHz)
square	5 s - 10 ns (0.2 Hz - 100 MHz)
sq20%	20 ms - 100 ns (50 kHz - 10 MHz)

- **TRIG** If you are using the external trigger, use this key to cycle through the trigger settings. The available trigger settings are: off, /1 (trigger signal appears on each marker), /10 (trigger signal appears on every tenth marker), and /100 (trigger signal appears at every 100th marker).

You can also toggle the trigger off and on by pressing **TRIG OUT**.

- **MODE** Indicates you are in MARKER mode. Use the softkey to change modes and open menus for other oscilloscope calibration modes.

Default marker values are 1.000 ms, SHAPE = spike.

The **MULT** and **DIV** keys step the voltages through cardinal point values of an oscilloscope in a 1-2-5 step sequence. For example, if the period is 1.000 ms, pressing **MULT** increases the period to the nearest cardinal point, which is 2.000 ms. Pressing **DIV** decreases the voltage to the nearest cardinal point, which is 500  $\mu$ s.

### 8-41. Time Base Marker Calibration Procedure for an Oscilloscope

This sample procedure uses the Time MARKER function to check the horizontal deflection (time base) of your oscilloscope. See your oscilloscope's manual for the exact time base values recommended for calibration.

Before you begin this procedure, verify that you are in MARKER mode. If you are, the Control Display shows the following menu.

Output at SCOPE terminal (50 $\Omega$ )	SHAPE spike	TRIG off	MODE marker
▲	▲	▲	▲

Perform the following sample procedure to calibrate the time base:

1. Connect the calibrator to Channel 1 on the oscilloscope. Select 50  $\Omega$  impedance or use an external 50  $\Omega$  termination. Make sure the oscilloscope is dc-coupled.
2. Apply a time marker value according to the recommended calibration settings in your oscilloscope manual. For example, to enter 200 ns, press

**2** **0** **0** **SHIFT** **n** **K** **SHIFT** **Hz**, then press **ENTER**.

*Note*

*You may enter the equivalent frequency instead of the time marker value.  
For example, instead of entering 200 ns, you may enter 5 MHz.*

3. Set your oscilloscope's time base to show 10 time markers. The time markers should align with the oscilloscope divisions, as shown in the example below.

For an accurate reading, align the signal's peaks with the horizontal center axis.

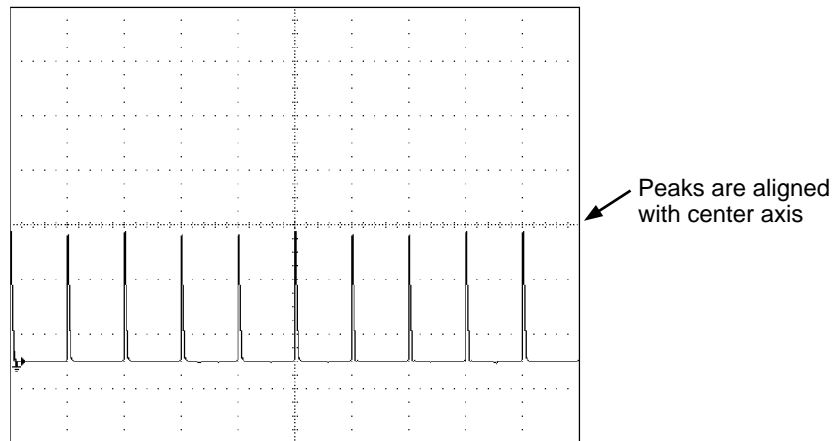

g1011i.eps

4. Repeat this procedure for all time marker values recommended for your oscilloscope. Repeat for digital and analog mode as required. Some oscilloscopes may need the magnification changed while calibrating in analog mode.
5. Remove the signal by pressing **STBY**.

## **8-42. Testing the Trigger**

The oscilloscope's ability to trigger on different waveforms can be tested using the wave generator. When the wave generator is used, a square, sine, or triangle wave is transmitted and the wave's output impedance, offset, and voltage can be varied in order to test the triggering capability at different levels.

*Note*

*The wave generator should not be used for checking the accuracy of your oscilloscope.*

The wave generator is available through the WAVEGEN menu, shown below. To access this menu, press the softkey under MODE until “wavegen” appears.

Output @ SCOPE	WAVE	SCOPE Z	OFFSET	MODE
▲	square	1 MΩ	+0.0V	wavegen
	square	1 MΩ		volt
	sine	50Ω		edge
	tri			levsine
				marker
				<b>wavegen</b>
				video
				pulse
				meas Z
				overld

You can press the MODE softkey to cycle through the functions in the order shown, or you can press **PREV MENU** to return directly to the OTHER modes menu.

Each option in the WAVEGEN menu is described below:

- **OUTPUT @ SCOPE** Indicates the location of the signal output. If the signal does not appear on the oscilloscope, press **OPR**. To disconnect the signal, press **STBY**.
- **WAVE** Scrolls through the three types of waveforms that are available. You can select a square, sine, or triangle wave as the output.
- **SCOPE Z** Toggles the calibrator’s output impedance setting between 50 Ω and 1 MΩ.
- **OFFSET** Displays the offset of the generated wave. To change the offset, key in the new value, and press **ENTER**. Using the rotary knob does not change the offset; it changes the actual voltage output.

When you change the offset, you must remain within certain limits to avoid clipping the peaks. The limit depends on the wave’s peak-to-peak value. Specifically, the peak excursion equals the absolute value of the offset plus half of the wave’s peak-to-peak value. See “Wave Generator Specifications” at the beginning of this chapter.

- **MODE** Indicates you are in WAVEGEN mode. Use the softkey to change modes and open menus for other oscilloscope calibration modes.

Default Wavegen settings are 20 mV p/p, 1000.0 Hz, WAVE = square, and offset = 0.0 V.

## 8-43. Testing Video Triggers

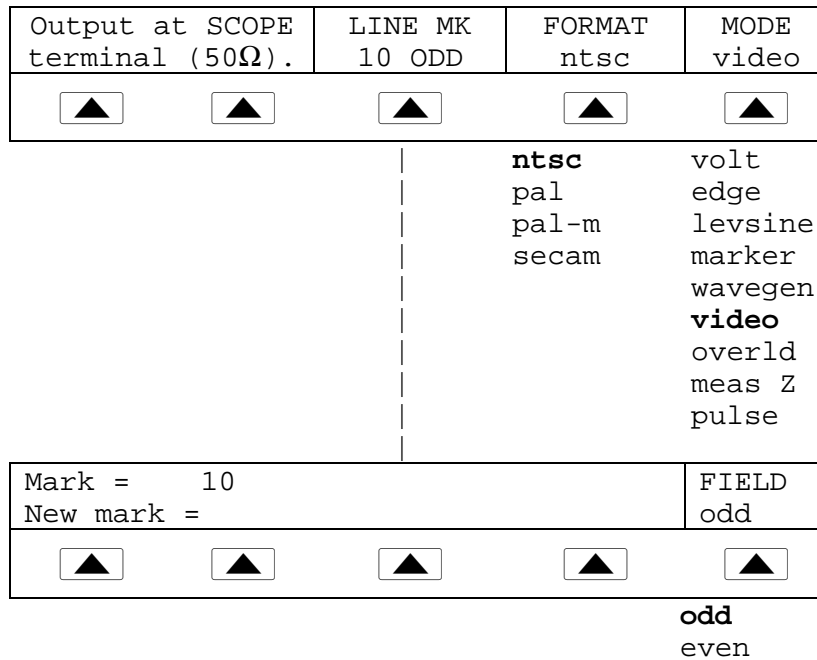

You can press the MODE softkey to cycle through the functions in the order shown, or you can press **PREV MENU** to return directly to the OTHER modes menu.

Each option in the VIDEO menu is described below:

- **Output @ SCOPE terminal (50 Ω)** Indicates the location of the signal output. If the signal does not appear on the oscilloscope, press **OPR**. To disconnect the signal, press **STBY**.
- **LINE MK** Allows you to select the marker line number. For ntsc and pal-m formats, you can also select field (“odd” or “even”). For pal and secam formats, the field (“ODD” or “EVEN”) is selected automatically based on marker line number.
- **FORMAT** Scrolls through the available formats. You can select ntsc, pal, pal-m, and secam.
- **MODE** Indicates the calibrator is in VIDEO mode. Use the softkey to change modes and open menus for other oscilloscope calibration modes.

Default video settings are + 100 %, format = NTSC, and videomark = 10.

## 8-44. Verifying Pulse Capture

Output @ SCOPE		AMPL 2.5V	TRIG off	MODE pulse
▲	▲	▲	▲	▲
		<b>2.5V</b>	<b>off</b>	volt
		1.0V	/1	edge
		250 mV	/10	levsine
		100 mV	/100	marker
		25 mV		wavegen
		10 mV		video
				<b>pulse</b>
				meas Z
				overld

You can press the MODE softkey to cycle through the functions in the order shown, or you can press **PREV MENU** to return directly to the OTHER modes menu.

Each option in the PULSE menu is described below:

- **OUTPUT @ SCOPE** Indicates the location of the signal output. If the signal does not appear on the oscilloscope, press **OPR**. To disconnect the signal, press **STBY**.
- **AMPL** Indicates the output level. You can select 2.5 V, 1.0 V, 250 mV, 100 mV, 25 mV, or 10 mV.
- **TRIG** If you are using the external trigger, use this key to cycle through the trigger settings. The available trigger settings are: off, /1 (trigger signal appears on each marker), /10 (trigger signal appears on every tenth marker), and /100 (trigger signal appears at every 100th marker).

You can also toggle the trigger off and on by pressing **TRIG OUT**.

- **MODE** Indicates you are in PULSE mode. Use the softkey to change modes and open menus for other oscilloscope calibration modes.

Default Pulse settings are 100.0 ns width and 1.000 ms period. To change these values, you have several options. Usually, you will enter values for both pulse width and period. Do this by entering the pulse width value with units first, followed immediately by the period value and units, followed by **ENTER**. For example, you could enter a pulse width of 50 ns and a period of 200 ns with the following sequence:

**5** **0** **SHIFT** **n K** **SHIFT** **sec Hz** **2** **0** **0** **SHIFT** **n K** **SHIFT** **sec Hz**  
**ENTER**

To change only the pulse width, enter a value in seconds. You can enter this value with units (e.g., 200 ns) or without units (e.g., 0.0000002). To change only the period, enter a frequency with units (e.g., 20 MHz, changing the period to 50 ns).

## 8-45. Measuring Input Resistance and Capacitance

Measured @ SCOPE terminal.		MEASURE res 50Ω	MODE meas Z
▲	▲	▲	▲
		res 50Ω	volt
		res 1MΩ	edge
		cap	levsine
			marker
			wavegen
			video
			pulse
			<b>meas Z</b>
			overld

You can press the MODE softkey to cycle through the functions in the order shown, or you can press **PREV MENU** to return directly to the OTHER modes menu.

Each option in the Impedance/Capacitance (MEAS Z) menu is described below:

- **Measured @ SCOPE terminal** Indicates the location of the measured input.
- **MEASURE** Indicates the type of test. You can select res 50 Ω or res 1 MΩ termination (for impedance) or cap (capacitance).
- **MODE** Indicates the Calibrator is in MEAS Z mode. Use the softkey to change modes and open menus for other oscilloscope calibration modes.

If you have selected Capacitance measurement, the menu appears as follows:

Measured @ SCOPE terminal.	SET OFFSET	MEASURE cap	MODE meas Z
▲	▲	▲	▲
	CLEAR OFFSET		

- **SET OFFSET** With the cable disconnected at the oscilloscope but still connected at the Calibrator, press to cancel the capacitance of the Calibrator. Press again to **CLEAR OFFSET** and return to the capacitance reading.

Default Impedance Measurement range = 50 ohm.

## 8-46. Input Impedance Measurement

With MEAS Z mode selected, perform the following procedure to measure the input impedance of an oscilloscope:

1. Use the MEASURE softkey to select “res 50 Ω” or “res 1 MΩ” termination.
2. Connect the SCOPE terminal on the calibrator to Channel 1 on the oscilloscope.
3. Press **OPR** to initiate the measurement.



### 8-47. Input Capacitance Measurement

With MEAS Z mode selected, perform the following procedure to measure the input capacitance of an oscilloscope:

1. Set the oscilloscope for 1 MΩ input impedance. Note that input capacitance testing cannot be done with 50 Ω input impedance.
2. Use the MEASURE softkey to select “cap”.
3. With the output cable connected to the Calibrator but not connected to the oscilloscope, press the SET OFFSET softkey to cancel stray capacitances.
4. Connect the output cable to Channel 1 on the oscilloscope.
5. Press **OPR** to initiate the measurement.

### 8-48. Testing Overload Protection



**Caution**

**This test checks the power handling capability of the 50 Ω input of your oscilloscope. Before proceeding, ensure that the power rating of your oscilloscope can handle the voltages and currents that this test can output. Failing to do so could damage your oscilloscope.**

Output @ SCOPE	UUTTRIP in 4.1s	T LIMIT 10s	OUT VAL DC	MODE overld
▲	▲	▲	▲	▲
			DC AC	volt edge levsine marker wavegen video pulse meas Z overld

You can press the MODE softkey to cycle through the functions in the order shown, or you can press **PREV MENU** to return directly to the OTHER modes menu.

Each option in the OVERLD menu is described below:

- **OUTPUT @ SCOPE** Indicates the location of the output signal.
- **UUTTRIP** Indicates test results. “NO” appears if the overload protection did not trip within the selected time limit. A value in seconds appears (e.g. “4.1 s”) if the overload protection has tripped within the time limit.
- **T LIMIT** indicates the selected time limit for application of the output value. Press this softkey to key in or edit a different time limit (1 s to 60 s allowed.)
- **OUT VAL** Indicates the output voltage type. You can select DC or AC and a value ranging from 5 V to 9 V (shown in Output Display). Key in or edit this value.
- **MODE** Indicates you are in OVERLD (Overload) mode. Use the softkey to change modes and open menus for other oscilloscope calibration modes.

Default overload settings are + 5.000 V and DC.

At any time, you can also set the overload time limit with the following command sequence:

INSTMT      OTHER  
SETUP      SETUP      TLIMDEF

                     (Choose 1 s to 60 s.)

Perform the following procedure to test the overload protection of an oscilloscope:

1. Connect the calibrator to Channel 1 on the oscilloscope.
2. Select the voltage type (DC or AC) using the OUT VAL softkey.
3. Key in the voltage level. (The default value is 5 V.)
4. If necessary, change the duration. (Refer to the procedure described above.) The default duration is 10s.
5. Check for test results displayed with the UUTTRIP softkey.

## 8-49. Remote Commands and Queries

This section describes commands and queries that are used specifically for the SC600 Option. Each command description indicates whether it can be used with IEEE-488 and RS-232 remote interfaces and identifies it as a Sequential, Overlapped, or Coupled command.

**IEEE-488 (GPIB) and RS-232 Applicability** Each command and query has a check box indicating applicability to IEEE-488 (general purpose interface bus, or GPIB) and RS-232 remote operations.

**Sequential Commands** Commands executed immediately as they are encountered in the data stream are called sequential commands. For more information, see “Sequential Commands” in Chapter 5.

**Overlapped Commands** Commands SCOPE, TRIG, and OUT\_IMP are designated as overlapped commands because they may be overlapped (interrupted) by the next command before they have completed execution. When an overlapped command is interrupted, it may take longer to execute while it waits for other commands to be completed. To prevent an overlapped command from being interrupted during execution, use \*OPC, \*OPC?, or \*WAI. These commands prevent interruptions until they detect the command’s completion. For more information, see “Overlapped Commands” in Chapter 5.

**Coupled Commands** SCOPE and OUT\_IMP are coupled commands because they can be coupled (combined) with other commands to form a compound command sequence. Care must be taken to ensure that commands are not coupled in a way that may cause them to disable each other, since this may result in a fault. For more information, see “Coupled Commands” in Chapter 5.

## 8-50. General Commands

### SCOPE

(IEEE-488, RS-232, Sequential)

Programs the 5520A-SC oscilloscope calibration hardware, if installed. The instrument settings are determined by this command's parameter. Once in SCOPE mode, use the OUT command to program new output in all functions except Impedance Measurement and the RANGE command as required (in OVERLD, PULSE, and MEAS Z functions only.) OPER, STBY, \*OPC, \*OPC?, and \*WAI all operate as described in Chapter 6. The state of the oscilloscope's output while in SCOPE mode is reflected by the bit in the ISR that is assigned to SETTLED.

**Table 8-15. SCOPE Command Parameters**

Parameter	Description/Example
OFF	Turns the oscilloscope hardware off. Programs 0 V, 0 Hz, output at the NORMAL terminals, standby.
VOLT	Oscilloscope ac and dc VOLT mode. Programs 20 mV peak-to-peak, 1 kHz, output at the SCOPE BNC, output impedance 1 M $\Omega$ , standby if from OFF or previously in standby. FUNC? returns SACV (for ac) or SDCV (for dc).
	Example:     SCOPE VOLT; OUT 4 V, 1 kHz  (ac voltage, 4 V peak-to-peak, 1 kHz.)
EDGE	Oscilloscope EDGE mode. Programs 25 mV peak-to-peak, 1 MHz, output at the SCOPE BNC, standby if from OFF or previously in standby. FUNC? returns EDGE.
	Example:     SCOPE EDGE; OUT 0.5 V, 5 kHz  (Edge, 0.5 V peak-to-peak, 5 kHz.)
LEVSINE	Oscilloscope LEVSINE mode. Programs 30 mV peak-to-peak, 50 kHz, output at the SCOPE BNC, standby if from OFF or previously in standby. FUNC? returns LEVSINE.
	Example:     SCOPE LEVSINE; OUT 1 V, 50 kHz  (Levelled sine wave, 1 V peak-to-peak, 50 kHz.)
MARKER	Oscilloscope MARKER mode. Programs the period to 1 ms, output at the SCOPE BNC, standby if from OFF or previously in standby. FUNC? returns MARKER.
	Example:     SCOPE MARKER; OUT 2 MS  (Marker, period of 2 ms.)
WAVEGEN	Oscilloscope WAVEGEN mode. Programs 20 mV peak-to-peak, square wave, 1 kHz, no offset, output impedance 1 M $\Omega$ , standby if from OFF or previously in standby. FUNC? returns WAVEGEN.
	Example:     SCOPE WAVEGEN; OUT 1 V, 1 kHz  (Wave Generator, 1 V peak-to-peak, 1 kHz.)

Table 8-15. SCOPE Command Parameters (cont.)

Parameter	Description/Example
VIDEO	Oscilloscope VIDEO mode. Programs 100% output (1V p/p), line marker 10, format NTSC. FUNC? returns VIDEO.
	Examples: SCOPE VIDEO; OUT 90 (Video, 90% output) SCOPE VIDEO; OUT -70 (Video, -70% output, inverse video)
PULSE	Oscilloscope PULSE mode. Programs 100 ns pulse width, 1.000 $\mu$ s period, 2.5 V range. FUNC? returns PULSE.
	Example: SCOPE PULSE; OUT 50 ns, 500 ns; RANGE TP8DB (Pulse, 50 ns pulse width, 500 ns period, 1.5 V range)
MEASZ	Oscilloscope Impedance/Capacitance measurement (MEAS Z) mode. Programs 50 $\Omega$ range. FUNC? returns MEASZ.
	Example: SCOPE MEASZ; RANGE TZCAP (MEAS Z mode, capacitance range)
OVERLD	Oscilloscope Overload mode. Programs 5 V dc range. FUNC? returns OVERLD.
	Example: SCOPE OVERLD; OUT 7 V; RANGE TOLAC (Overload, 7 V output, ac range)

### SCOPE?

(IEEE-488, RS-232, Sequential)

Returns the oscilloscope's current mode of operation. Returns OFF if the oscilloscope is off.

Parameter: (None)

Response: <character> (Returns OFF, VOLT, EDGE, LEVSINE, MARKER, WAVEGEN, VIDEO, PULSE, MEASZ, or OVERLD.)

### TRIG

(IEEE-488, RS-232, Overlapped)

Programs the oscilloscope's trigger output BNC.

Parameters: OFF (Turns the trigger output off.)  
 DIV1 (Turns the trigger output on. Frequency is the same as the signal at SCOPE output.)  
 DIV10 (Turns the trigger output on. Frequency is 1/10 of the signal at SCOPE output.)  
 DIV100 (Turns the trigger output on. Frequency is 1/100 of the signal at SCOPE output.)

Example: TRIG DIV10

**TRIG?**

(IEEE-488, RS-232, Sequential)

Returns the output setting of the oscilloscope's trigger.

Parameters: (None)

Response: <character> (Returns OFF, DIV1, DIV10, or DIV100.)

**OUT\_IMP**

(IEEE-488, RS-232, Sequential)

Programs the oscilloscope's output impedance.

Parameters: Z50 (Programs the oscilloscope's output impedance to 50  $\Omega$ .)

Z1M (Programs the oscilloscope's output impedance to 1 M $\Omega$ .)

Example: OUT\_IMP Z50

**OUT\_IMP?**

(IEEE-488, RS-232, Sequential)

Returns the impedance setting of the oscilloscope's output.

Parameters: (None)

**RANGE**

(IEEE-488, RS-232, Sequential)

Programs the instrument range in PULSE, MEAS Z, OVERLD modes.

Parameters:

Pulse	TP0DB	TP8DB	TP20DB	TP28DB	TP40DB	TP48DB
Range	2.5 V	1.0 V	250 mV	100 mV	25 mV	10 mV

Impedance Measure	TZ50OHM	TZ1MOHM	TZCAP
Range	res 50 $\Omega$	res 1M $\Omega$	cap

Overload	TOLDC	TOLAC
Range	DC	AC

Example: RANGE TP20DB

### 8-51. Edge Function Commands

#### TDPULSE

(IEEE-488, RS-232, Sequential)

Turn tunnel diode pulse drive on/off in EDGE mode.

Parameters: ON (or non-zero) or OFF (or zero)

Example: TDPULSE ON

Returns the tunnel diode pulse drive setting in EDGE mode.

Parameters: None

Response: 1 if ON, 0 if OFF.

### 8-52. Marker Function Commands

#### TMWAVE

(IEEE-488, RS-232, Sequential)

Selects the waveform for MARKER mode.

Parameters: SINE Sine wave (2 ns to 15 ns)

SPIKE Triangular/sawtooth pulse (15 ns to 5 s)

SQUARE Square wave (50% duty cycle) (4 ns to 5 s)

SQ20PCT Square wave (20% duty cycle) (85 ns to 5 s)

Example: TMWAVE SPIKE

#### TMWAVE?

(IEEE-488, RS-232, Sequential)

Returns the MARKER mode waveform setting.

Parameters: None

Response: <character> (Returns SINE, SPIKE, SQUARE, or SQ20PCT.)

### 8-53. Video Function Commands

#### VIDEOFMT

(IEEE-488, RS-232, Sequential)

Selects the format for VIDEO mode.

Parameters: NTSC, PAL, PALM (for PAL-M), or SECAM

Example: VIDEOFMT SECAM

**VIDEOFMT?**

(IEEE-488, RS-232, Sequential)

Returns the VIDEO mode format.

Parameters: None

Response: NTSC, PAL, PALM (for PAL-M), or SECAM

**VIDEOMARK**

(IEEE-488, RS-232, Sequential)

Programs the VIDEO mode line marker location.

Parameters: Line marker number.

Example: VIDEOMARK 10

**VIDEOMARK?**

(IEEE-488, RS-232, Sequential)

Returns the VIDEO mode line marker setting.

Parameters: None.

Response: <character> SINE, SPIKE, SQUARE or SQ20PCT

**8-54. Overload Function Commands****OL\_TRIP?**

(IEEE-488, RS-232, Sequential)

Returns the detected state of scope overload protection.

Parameters: (None)

Response: Returns the number of seconds before protection was tripped. Returns 0 if protection has not been tripped or if OVERLD mode not active.

**TLIMIT**

(IEEE-488, RS-232, Sequential)

Sets the OPERATE time limit for the OVERLD mode signal. The Calibrator automatically returns to STANDBY if the UUT protection trips within this interval or at the end of this interval if the protection has not tripped.

Parameters: 1 to 60 (seconds)

Example: TLIMIT 30

**TLIMIT?**

(IEEE-488, RS-232, Sequential)

Returns the programmed OPERATE time limit for the OVERLD mode signal.

Response: <Integer> Time limit in seconds.

### **TLIMIT\_D**

(IEEE-488, RS-232, Sequential)

Sets the default OPERATE time limit for the OVERLD mode signal.

Parameters: 1 to 60 (seconds)

Example: TLIMIT\_D 15

### **TLIMIT\_D?**

(IEEE-488, RS-232, Sequential)

Returns the default overload time limit.

Response: <Integer> Default time limit in seconds.

## **8-55. Impedance/Capacitance Function Commands**

### **ZERO\_MEAS**

(IEEE-488, RS-232, Sequential)

Sets the measurement offset to the capacitance value.

Parameters: (boolean) ON or OFF.

### **\*TRG**

(IEEE-488, RS-232, Sequential)

Triggers and returns a new impedance measurement value when used with the SC600 option in MEAS Z mode. (See Chapter 6 for \*TRG use in all cases except MEAS Z mode with the SC600 option.)

Responses: <measurement value>, OHM (input impedance value in ohms)  
<measurement value>, F (input capacitance value in farads)  
<measurement value>, NONE (no measurement is available)

Example: \*TRG returns 1.00E+03, OHM (1 k $\Omega$  input impedance).

#### *Note*

*You can also use the VAL? query to return an impedance measurement value with the SC600 option. VAL? returns the last measurement, whereas \*TRG gets a new measurement. Responses are the same as shown above for the \*TRG command. (See Chapter 6 for VAL? use with thermocouple measurements.)*



## 8-56. Verification Tables

The verification test points are provided here as a guide when verification to one-year specifications is desired.

### 8-57. DC Voltage Verification

Table 8-16. DC Voltage Verification

(1M $\Omega$ output impedance unless noted)			
Nominal Value (V dc)	Measured Value (V dc)	Deviation (V dc)	1-Year Spec. (V dc)
0			0.00004
0.00125			0.000040625
-0.00125			0.000040625
0.00249			0.000041245
-0.00249			0.000041245
0.0025			0.00004125
-0.0025			0.00004125
0.00625			0.000043125
-0.00625			0.000043125
0.0099			0.00004495
-0.0099			0.00004495
0.01			0.000045
-0.01			0.000045
0.0175			0.00004875
-0.0175			0.00004875
0.0249			0.00005245
-0.0249			0.00005245
0.025			0.0000525
-0.025			0.0000525
0.0675			0.00007375
-0.0675			0.00007375
0.1099			0.00009495
-0.1099			0.00009495
0.11			0.000095
-0.11			0.000095
0.305			0.0001925
-0.305			0.0001925
0.499			0.0002895
-0.499			0.0002895
0.5			0.00029
-0.5			0.00029
1.35			0.000715
-1.35			0.000715
2.19			0.001135
-2.19			0.001135
2.2			0.00114
-2.2			0.00114
6.6			0.00334
-6.6			0.00334

Table 8-16. DC Voltage Verification (cont.)

Nominal Value (V dc)	Measured Value (V dc)	Deviation (V dc)	1-Year Spec. (V dc)
10.99			0.005535
-10.99			0.005535
11			0.00554
-11			0.00554
70.5			0.03529
-70.5			0.03529
130			0.06504
-130			0.06504
6.599 (50 Ω)			0.0165375

**8-58. AC Voltage Amplitude Verification**

Table 8-17. AC Voltage Amplitude Verification

(1 MΩ output impedance unless noted)				
Nominal Value (V p-p)	Frequency (Hz)	Measured Value (V p-p)	Deviation (V p-p)	1-year Spec. (V p-p)
0.001	1000			0.000041
-0.001	1000			0.000041
0.01	1000			0.00005
-0.01	1000			0.00005
0.025	1000			0.000065
-0.025	1000			0.000065
0.11	1000			0.00015
-0.11	1000			0.00015
0.5	1000			0.00054
-0.5	1000			0.00054
2.2	1000			0.00224
-2.2	1000			0.00224
11	1000			0.01104
-11	1000			0.01104
130	1000			0.13004
-130	1000			0.13004
6.599 (50 Ω)	1000			0.0165375

**8-59. AC Voltage Frequency Verification**

Table 8-18. AC Voltage Frequency Verification

(1 MΩ output impedance unless noted)				
Nominal Value (V p-p)	Frequency (Hz)	Measured Value (Hz)	Deviation (Hz)	1-year Spec. (Hz)
2.1	10			0.000025
2.1	100			0.00025
2.1	1000			0.0025
2.1	10000			0.025

**8-60. Wave Generator Amplitude Verification: 1 MΩ Output Impedance**

**Table 8-19. Wave Generator Amplitude Verification (1 MΩ output impedance)**

Wave Shape	Nominal Value (V p-p)	Frequency (Hz)	Measured Value (V p-p)	Deviation (V p-p)	1-Year Spec. (V p-p)
square	0.0018	1000			0.000154
square	0.0119	1000			0.000457
square	0.0219	1000			0.000757
square	0.022	1000			0.00076
square	0.056	1000			0.00178
square	0.0899	1000			0.002797
square	0.09	1000			0.0028
square	0.155	1000			0.00475
square	0.219	1000			0.00667
square	0.22	1000			0.0067
square	0.56	1000			0.0169
square	0.899	1000			0.02707
square	0.9	1000			0.0271
square	3.75	1000			0.1126
square	6.59	1000			0.1978
square	6.6	1000			0.1981
square	30.8	1000			0.9241
square	55	10			1.6501
square	55	100			1.6501
square	55	1000			1.6501
square	55	10000			1.6501
sine	0.0018	1000			0.000154
sine	0.0219	1000			0.000757
sine	0.0899	1000			0.002797
sine	0.219	1000			0.00667
sine	0.899	1000			0.02707
sine	6.59	1000			0.1978
sine	55	1000			1.6501
triangle	0.0018	1000			0.000154
triangle	0.0219	1000			0.000757
triangle	0.0899	1000			0.002797
triangle	0.219	1000			0.00667
triangle	0.899	1000			0.02707
triangle	6.59	1000			0.1978
triangle	55	1000			1.6501

**8-61. Wave Generator Amplitude Verification: 50Ω Output Impedance**

**Table 8-20. Wave Generator Amplitude Verification (50Ω output impedance)**

Wave Shape	Nominal Value (V p-p)	Frequency (Hz)	Measured Value (V p-p)	Deviation (V p-p)	1-Year Spec. (V p-p)
square	0.0018	1000			0.000154
square	0.0064	1000			0.000292
square	0.0109	1000			0.000427
square	0.011	1000			0.00043
square	0.028	1000			0.00094
square	0.0449	1000			0.001447
square	0.045	1000			0.00145
square	0.078	1000			0.00244
square	0.109	1000			0.00337
square	0.11	1000			0.0034
square	0.28	1000			0.0085
square	0.449	1000			0.01357
square	0.45	1000			0.0136
square	0.78	1000			0.0235
square	1.09	1000			0.0328
square	1.1	1000			0.0331
square	1.8	1000			0.0541
square	2.5	10			0.0751
square	2.5	100			0.0751
square	2.5	1000			0.0751
square	2.5	10000			0.0751
sine	0.0018	1000			0.000154
sine	0.0109	1000			0.000427
sine	0.0449	1000			0.001447
sine	0.109	1000			0.00337
sine	0.449	1000			0.01357
sine	1.09	1000			0.0328
sine	2.5	1000			0.0751
triangle	0.0018	1000			0.000154
triangle	0.0109	1000			0.000427
triangle	0.0449	1000			0.001447
triangle	0.109	1000			0.00337
triangle	0.449	1000			0.01357
triangle	1.09	1000			0.0328
triangle	2.5	1000			0.0751

**8-62. Leveled Sinewave Verification: Amplitude**

**Table 8-21. Leveled Sinewave Verification: Amplitude**

Nominal Value (V p-p)	Frequency	Measured Value (V p-p)	Deviation (V p-p)	1-Year Spec. (V p-p)
0.005	50 kHz			0.0004
0.0075	50 kHz			0.00045
0.0099	50 kHz			0.000498
0.01	50 kHz			0.0005
0.025	50 kHz			0.0008
0.039	50 kHz			0.00108
0.04	50 kHz			0.0011
0.07	50 kHz			0.0017
0.099	50 kHz			0.00228
0.1	50 kHz			0.0023
0.25	50 kHz			0.0053
0.399	50 kHz			0.00828
0.4	50 kHz			0.0083
0.8	50 kHz			0.0163
1.2	50 kHz			0.0243
1.3	50 kHz			0.0263
3.4	50 kHz			0.0683
5.5	50 kHz			0.1103

**8-63. Leveled Sinewave Verification: Frequency**

**Table 8-22. Leveled Sinewave Verification: Frequency**

Nominal Value (V p-p)	Frequency	Measured Value (Hz)	Deviation (Hz)	1-Year Spec. (Hz)
5.5	50 kHz			0.125
5.5	500 kHz			1.25
5.5	5 MHz			12.5
5.5	50 MHz			125
5.5	500 MHz			1250

**8-64. Leveled Sinewave Verification: Harmonics**

**Table 8-23. Leveled Sinewave Verification: Harmonics**

Harmonic	Nominal Value (V p-p)	Frequency	Measured Value (dB)	Deviation (dB)	1-Year Spec. (dB)
2nd harmonic	0.0399	50 kHz			-33
3rd+ harmonic	0.0399	50 kHz			-38
2nd harmonic	0.099	50 kHz			-33
3rd+ harmonic	0.099	50 kHz			-38
2nd harmonic	0.399	50 kHz			-33
3rd+ harmonic	0.399	50 kHz			-38
2nd harmonic	1.2	50 kHz			-33
3rd+ harmonic	1.2	50 kHz			-38
2nd harmonic	5.5	50 kHz			-33
3rd+ harmonic	5.5	50 kHz			-38
2nd harmonic	5.5	100 kHz			-33
3rd+ harmonic	5.5	100 kHz			-38
2nd harmonic	5.5	200 kHz			-33
3rd+ harmonic	5.5	200 kHz			-38
2nd harmonic	5.5	400 kHz			-33
3rd+ harmonic	5.5	400 kHz			-38
2nd harmonic	5.5	800 kHz			-33
3rd+ harmonic	5.5	800 kHz			-38
2nd harmonic	5.5	1 MHz			-33
3rd+ harmonic	5.5	1 MHz			-38
2nd harmonic	5.5	2 MHz			-33
3rd+ harmonic	5.5	2 MHz			-38
2nd harmonic	5.5	4 MHz			-33
3rd+ harmonic	5.5	4 MHz			-38
2nd harmonic	5.5	8 MHz			-33
3rd+ harmonic	5.5	8 MHz			-38
2nd harmonic	5.5	10 MHz			-33
3rd+ harmonic	5.5	10 MHz			-38
2nd harmonic	5.5	20 MHz			-33
3rd+ harmonic	5.5	20 MHz			-38
2nd harmonic	5.5	40 MHz			-33
3rd+ harmonic	5.5	40 MHz			-38
2nd harmonic	5.5	80 MHz			-33
3rd+ harmonic	5.5	80 MHz			-38
2nd harmonic	5.5	100 MHz			-33
3rd+ harmonic	5.5	100 MHz			-38
2nd harmonic	5.5	200 MHz			-33
3rd+ harmonic	5.5	200 MHz			-38
2nd harmonic	5.5	400 MHz			-33
3rd+ harmonic	5.5	400 MHz			-38
2nd harmonic	5.5	600 MHz			-33
3rd+ harmonic	5.5	600 MHz			-38

**8-65. Leveled Sinewave Verification: Flatness****Table 8-24. Leveled Sinewave Verification: Flatness**

Nominal Value (V p-p)	Frequency	Measured Value (V p-p)	Deviation (V p-p)	1-Year Spec. (V p-p)
0.005	50 kHz		na	na
0.005	30 MHz			0.000175
0.005	70 MHz			0.000175
0.005	120 MHz			0.0002
0.005	290 MHz			0.0002
0.005	360 MHz			0.0003
0.005	390 MHz			0.0003
0.005	400 MHz			0.0003
0.005	480 MHz			0.0003
0.005	570 MHz			0.0003
0.005	580 MHz			0.0003
0.005	590 MHz			0.0003
0.005	600 MHz			0.0003
0.0075	50 kHz		na	na
0.0075	30 MHz			0.0002125
0.0075	70 MHz			0.0002125
0.0075	120 MHz			0.00025
0.0075	290 MHz			0.00025
0.0075	360 MHz			0.0004
0.0075	390 MHz			0.0004
0.0075	400 MHz			0.0004
0.0075	480 MHz			0.0004
0.0075	570 MHz			0.0004
0.0075	580 MHz			0.0004
0.0075	590 MHz			0.0004
0.0075	600 MHz			0.0004
0.0099	50 kHz		na	na
0.0099	30 MHz			0.0002485
0.0099	70 MHz			0.0002485
0.0099	120 MHz			0.000298
0.0099	290 MHz			0.000298
0.0099	360 MHz			0.000496
0.0099	390 MHz			0.000496
0.0099	400 MHz			0.000496
0.0099	480 MHz			0.000496
0.0099	570 MHz			0.000496
0.0099	580 MHz			0.000496
0.0099	590 MHz			0.000496
0.0099	600 MHz			0.000496

Table 8-24. Leveled Sinewave Verification: Flatness (cont.)

Nominal Value (V p-p)	Frequency	Measured Value (V p-p)	Deviation (V p-p)	1-Year Spec. (V p-p)
0.01	50 kHz		na	na
0.01	30 MHz			0.00025
0.01	70 MHz			0.00025
0.01	120 MHz			0.0003
0.01	290 MHz			0.0003
0.01	360 MHz			0.0005
0.01	390 MHz			0.0005
0.01	400 MHz			0.0005
0.01	480 MHz			0.0005
0.01	570 MHz			0.0005
0.01	580 MHz			0.0005
0.01	590 MHz			0.0005
0.01	600 MHz			0.0005
0.025	50 kHz		na	na
0.025	30 MHz			0.000475
0.025	70 MHz			0.000475
0.025	120 MHz			0.0006
0.025	290 MHz			0.0006
0.025	360 MHz			0.0011
0.025	390 MHz			0.0011
0.025	400 MHz			0.0011
0.025	480 MHz			0.0011
0.025	570 MHz			0.0011
0.025	580 MHz			0.0011
0.025	590 MHz			0.0011
0.025	600 MHz			0.0011
0.039	50 kHz		na	na
0.039	30 MHz			0.000685
0.039	70 MHz			0.000685
0.039	120 MHz			0.00088
0.039	290 MHz			0.00088
0.039	360 MHz			0.00166
0.039	390 MHz			0.00166
0.039	400 MHz			0.00166
0.039	480 MHz			0.00166
0.039	570 MHz			0.00166
0.039	580 MHz			0.00166
0.039	590 MHz			0.00166
0.039	600 MHz			0.00166
0.04	50 kHz		na	na
0.04	30 MHz			0.0007



Table 8-24. Leveled Sinewave Verification: Flatness (cont.)

Nominal Value (V p-p)	Frequency	Measured Value (V p-p)	Deviation (V p-p)	1-Year Spec. (V p-p)
0.04	70 MHz			0.0007
0.04	120 MHz			0.0009
0.04	290 MHz			0.0009
0.04	360 MHz			0.0017
0.04	390 MHz			0.0017
0.04	400 MHz			0.0017
0.04	480 MHz			0.0017
0.04	570 MHz			0.0017
0.04	580 MHz			0.0017
0.04	590 MHz			0.0017
0.04	600 MHz			0.0017
0.07	50 kHz		na	na
0.07	30 MHz			0.00115
0.07	70 MHz			0.00115
0.07	120 MHz			0.0015
0.07	290 MHz			0.0015
0.07	360 MHz			0.0029
0.07	390 MHz			0.0029
0.07	400 MHz			0.0029
0.07	480 MHz			0.0029
0.07	570 MHz			0.0029
0.07	580 MHz			0.0029
0.07	590 MHz			0.0029
0.07	600 MHz			0.0029
0.099	50 kHz		na	na
0.099	30 MHz			0.001585
0.099	70 MHz			0.001585
0.099	120 MHz			0.00208
0.099	290 MHz			0.00208
0.099	360 MHz			0.00406
0.099	390 MHz			0.00406
0.099	400 MHz			0.00406
0.099	480 MHz			0.00406
0.099	570 MHz			0.00406
0.099	580 MHz			0.00406
0.099	590 MHz			0.00406
0.099	600 MHz			0.00406
0.1	50 kHz		na	na
0.1	30 MHz			0.0016
0.1	70 MHz			0.0016
0.1	120 MHz			0.0021

Table 8-24. Leveled Sinewave Verification: Flatness (cont.)

Nominal Value (V p-p)	Frequency	Measured Value (V p-p)	Deviation (V p-p)	1-Year Spec. (V p-p)
0.1	290 MHz			0.0021
0.1	360 MHz			0.0041
0.1	390 MHz			0.0041
0.1	400 MHz			0.0041
0.1	480 MHz			0.0041
0.1	570 MHz			0.0041
0.1	580 MHz			0.0041
0.1	590 MHz			0.0041
0.1	600 MHz			0.0041
0.25	50 kHz		na	na
0.25	30 MHz			0.00385
0.25	70 MHz			0.00385
0.25	120 MHz			0.0051
0.25	290 MHz			0.0051
0.25	360 MHz			0.0101
0.25	390 MHz			0.0101
0.25	400 MHz			0.0101
0.25	480 MHz			0.0101
0.25	570 MHz			0.0101
0.25	580 MHz			0.0101
0.25	590 MHz			0.0101
0.25	600 MHz			0.0101
0.399	50 kHz		na	na
0.399	30 MHz			0.006085
0.399	70 MHz			0.006085
0.399	120 MHz			0.00808
0.399	290 MHz			0.00808
0.399	360 MHz			0.01606
0.399	390 MHz			0.01606
0.399	400 MHz			0.01606
0.399	480 MHz			0.01606
0.399	570 MHz			0.01606
0.399	580 MHz			0.01606
0.399	590 MHz			0.01606
0.399	600 MHz			0.01606
0.4	50 kHz		na	na
0.4	30 MHz			0.0061
0.4	70 MHz			0.0061
0.4	120 MHz			0.0081
0.4	290 MHz			0.0081
0.4	360 MHz			0.0161

Table 8-24. Leveled Sinewave Verification: Flatness (cont.)

Nominal Value (V p-p)	Frequency	Measured Value (V p-p)	Deviation (V p-p)	1-Year Spec. (V p-p)
0.4	390 MHz			0.0161
0.4	400 MHz			0.0161
0.4	480 MHz			0.0161
0.4	570 MHz			0.0161
0.4	580 MHz			0.0161
0.4	590 MHz			0.0161
0.4	600 MHz			0.0161
0.8	50 kHz		na	na
0.8	30 MHz			0.0121
0.8	70 MHz			0.0121
0.8	120 MHz			0.0161
0.8	290 MHz			0.0161
0.8	360 MHz			0.0321
0.8	390 MHz			0.0321
0.8	400 MHz			0.0321
0.8	480 MHz			0.0321
0.8	570 MHz			0.0321
0.8	580 MHz			0.0321
0.8	590 MHz			0.0321
0.8	600 MHz			0.0321
1.2	50 kHz		na	na
1.2	30 MHz			0.0181
1.2	70 MHz			0.0181
1.2	120 MHz			0.0241
1.2	290 MHz			0.0241
1.2	360 MHz			0.0481
1.2	390 MHz			0.0481
1.2	400 MHz			0.0481
1.2	480 MHz			0.0481
1.2	570 MHz			0.0481
1.2	580 MHz			0.0481
1.2	590 MHz			0.0481
1.2	600 MHz			0.0481
1.3	50 kHz		na	na
1.3	30 MHz			0.0196
1.3	70 MHz			0.0196
1.3	120 MHz			0.0261
1.3	290 MHz			0.0261
1.3	360 MHz			0.0521
1.3	390 MHz			0.0521
1.3	400 MHz			0.0521

Table 8-24. Leveled Sinewave Verification: Flatness (cont.)

Nominal Value (V p-p)	Frequency	Measured Value (V p-p)	Deviation (V p-p)	1-Year Spec. (V p-p)
1.3	480 MHz			0.0521
1.3	570 MHz			0.0521
1.3	580 MHz			0.0521
1.3	590 MHz			0.0521
1.3	600 MHz			0.0521
3.4	50 kHz		na	na
3.4	30 MHz			0.0511
3.4	70 MHz			0.0511
3.4	120 MHz			0.0681
3.4	290 MHz			0.0681
3.4	360 MHz			0.1361
3.4	390 MHz			0.1361
3.4	400 MHz			0.1361
3.4	480 MHz			0.1361
3.4	570 MHz			0.1361
3.4	580 MHz			0.1361
3.4	590 MHz			0.1361
3.4	600 MHz			0.1361
5.5	50 kHz		na	na
5.5	30 MHz			0.0826
5.5	70 MHz			0.0826
5.5	120 MHz			0.1101
5.5	290 MHz			0.1101
5.5	360 MHz			0.2201
5.5	390 MHz			0.2201
5.5	400 MHz			0.2201
5.5	480 MHz			0.2201
5.5	570 MHz			0.2201
5.5	580 MHz			0.2201
5.5	590 MHz			0.2201
5.5	600 MHz			0.2201

**8-66. Edge Verification: Amplitude**

Table 8-25. Edge Verification: Amplitude

Nominal Value (V p-p)	Frequency (Hz)	Measured Value (V p-p)	Deviation (V p-p)	1-Year Spec. (V p-p)
0.005	1 kHz			0.0003
0.005	10 kHz			0.0003
0.005	100 kHz			0.0003
0.01	100 kHz			0.0004
0.025	100 kHz			0.0007
0.05	100 kHz			0.0012
0.1	100 kHz			0.0022
0.25	100 kHz			0.0052
0.5	100 kHz			0.0102
1	100 kHz			0.0202
2.5	100 kHz			0.0502
2.5	10 kHz			0.0502
2.5	1 kHz			0.0502

**8-67. Edge Verification: Frequency**

Table 8-26. Edge Verification: Frequency

Nominal Value (V p-p)	Frequency	Measured Value (Hz)	Deviation (Hz)	1-Year Spec. (Hz)
2.5	1 kHz			0.0025
2.5	10 kHz			0.025
2.5	100 kHz			0.25
2.5	1 MHz			2.5
2.5	10 MHz			25

**8-68. Edge Verification: Duty Cycle**

Table 8-27. Edge Verification: Duty Cycle

Nominal Value (V p-p)	Frequency	Measured Value (%)	Deviation (from 50%)	1-Year Spec. (%)
2.5	1 MHz			5

**8-69. Edge Verification: Rise Time**

Table 8-28. Edge Verification: Rise Time

Nominal Value (V p-p)	Frequency	Measured Value (s)	Deviation (ns)	1-Year Spec. (ns)
0.25	1 kHz			0.3 ns
0.25	100 kHz			0.3 ns
0.25	10 MHz			0.3 ns
0.5	1 kHz			0.3 ns
0.5	100 kHz			0.3 ns
0.5	10 MHz			0.3 ns
1	1 kHz			0.3 ns
1	100 kHz			0.3 ns
1	10 MHz			0.3 ns
2.5	1 kHz			0.3 ns
2.5	100 kHz			0.3 ns
2.5	10 MHz			0.3 ns

**8-70. Tunnel Diode Pulser Verification**

Table 8-29. Tunnel Diode Pulser Verification

Nominal Value (V p-p)	Frequency (Hz)	Measured Value (V p-p)	Deviation (V p-p)	1-Year Spec. (V p-p)
11	100			0.2202
11	10000			0.2202
55	100			1.1002
55	10000			1.1002
100	100			2.0002
100	10000			2.0002

**8-71. Marker Generator Verification**

**Table 8-30. Marker Generator Verification**

Period (s)	Measured Value (s)	Deviation (s)	1-Year Spec. (s)
4.979 s			24.91E-3 s
2.002 s			4.06E-3 s
50.0 ms			3.75E-6 s
20.0 ms			50E-9 s
10.0 ms			25E-09 s
50.0 us			125E-12 s
20.0 us			50E-15 s
10.0 ns			25E-15 s
50.0 ns			125E-15 s
20.0 ns			50E-15 s
10.0 ns			25E-15 s
5.00 ns			12.5E-15 s
2.00 ns			5E-15 s

**8-72. Pulse Generator Verification: Period**

**Table 8-31. Pulse Generator Verification: Period**

Nominal Value (V p-p)	Pulse Width (s)	Period (s)	Measured Value (s)	Deviation (s)	1-Year Spec. (s)
2.5	8E-08	2E-06			5E-12
2.5	0.0000005	0.01			2.5E-08
2.5	0.0000005	0.02			5E-08

**8-73. Pulse Generator Verification: Pulse Width**

**Table 8-32. Pulse Generator Verification: Pulse Width**

Nominal Value (V p-p)	Pulse Width (s)	Period (s)	Measured Value (s)	Deviation (s)	1-Year Spec.
2.5	4.0E-9	2.0E-6			2.2 ns
2.5	4.0E-9	2.0E-5			2.2 ns
2.5	4.0E-9	2.0E-4			2.2 ns
2.5	4.0E-8	2.0E-3			4 ns

**8-74. Input Impedance Verification: Resistance**

**Table 8-33. Input Impedance Verification: Resistance**

<b>Nominal Value (<math>\Omega</math>)</b>	<b>Measured Value (<math>\Omega</math>)</b>	<b>Deviation (<math>\Omega</math>)</b>	<b>1-Year Spec. (<math>\Omega</math>)</b>
40			0.04
50			0.05
60			0.06
600000			600
1000000			1000
1500000			1500

**8-75. Input Impedance Verification: Capacitance**

**Table 8-34. Input Impedance Verification: Capacitance**

<b>Nominal Value (pF)</b>	<b>Measured Value (pF)</b>	<b>Deviation (pF)</b>	<b>1-Year Spec. (pF)</b>
5 pF			0.75 pF
29 pF			1.95 pF
49 pF			2.95 pF



# 5500A-SC300 Option

<b>Contents</b>		<b>Page</b>
8-76.	Introduction.....	8-59
8-77.	Oscilloscope Calibration Option Specifications.....	8-60
8-78.	Volt Function Specifications.....	8-60
8-79.	Edge Function Specifications.....	8-61
8-80.	Leveled Sine Wave Function Specifications.....	8-62
8-81.	Time Marker Function Specifications.....	8-63
8-82.	Wave Generator Specifications.....	8-63
8-83.	Trigger Signal Specifications for the Time Marker Function.....	8-64
8-84.	Trigger Signal Specifications for the Edge Function.....	8-64
8-85.	Oscilloscope Connections.....	8-65
8-86.	Starting the Oscilloscope Calibration Option.....	8-66
8-87.	The Output Signal.....	8-66
8-88.	Adjusting the Output Signal.....	8-67
8-89.	Keying in a Value.....	8-67
8-90.	Adjusting Values with the Rotary Knob.....	8-67
8-91.	Using <input type="button" value="MULT"/> and <input type="button" value="DIV"/> .....	8-68
8-92.	Resetting the Oscilloscope Option.....	8-68
8-93.	Calibrating the Voltage Amplitude on an Oscilloscope.....	8-69
8-94.	The Volt Function.....	8-69
8-95.	The V/DIV Menu.....	8-70
8-96.	Shortcuts for Setting the Voltage Amplitude.....	8-70
8-97.	Amplitude Calibration Procedure for an Oscilloscope.....	8-71
8-98.	Calibrating the Pulse and Frequency Response on an Oscilloscope....	8-72
8-99.	The Edge Function.....	8-72
8-100.	Pulse Response Calibration Procedure for an Oscilloscope.....	8-73
8-101.	The Leveled Sine Wave Function.....	8-74
8-102.	Shortcuts for Setting the Frequency and Voltage.....	8-74
8-103.	The MORE OPTIONS Menu.....	8-75
8-104.	Sweeping through a Frequency Range.....	8-77
8-105.	Frequency Response Calibration Procedure for an Oscilloscope....	8-78
8-106.	Calibrating the Time Base of an Oscilloscope.....	8-80
8-107.	The Time Marker Function.....	8-80
8-108.	Time Base Marker Calibration Procedure for an Oscilloscope.....	8-81
8-109.	Testing the Trigger.....	8-82
8-110.	Summary of Commands and Queries.....	8-83

8-111.	Verification Tables .....	8-86
8-112.	Voltage Function Verification: AC Voltage into a 1 M $\Omega$ Load .....	8-86
8-113.	Voltage Function Verification: AC Voltage into a 50 $\Omega$ Load .....	8-87
8-114.	Voltage Function Verification: DC Voltage into a 50 $\Omega$ Load .....	8-88
8-115.	Voltage Function Verification: DC Voltage into a 1 M $\Omega$ Load .....	8-89
8-116.	Edge Function Verification .....	8-90
8-117.	Wave Generator Function Verification: 1 M $\Omega$ Load .....	8-90
8-118.	Wave Generator Function Verification: 50 $\Omega$ Load .....	8-91
8-119.	Leveled Sinewave Function Verification: Amplitude .....	8-91
8-120.	Leveled Sinewave Function Verification: Flatness .....	8-92
8-121.	Leveled Sinewave Function Verification: Frequency .....	8-95
8-122.	Marker Generator Function Verification .....	8-96

## 8-76. Introduction

The Oscilloscope Calibration Option provides functions that help you maintain your oscilloscope's accuracy by verifying the following oscilloscope characteristics:

- Vertical deflection characteristics are verified by calibrating the voltage gain. The Volt function lets you compare the voltage gain to the graticule lines on the oscilloscope.
- Pulse response is checked using the Edge function, by verifying the accuracy of the oscilloscope's measurement of pulse transitions.
- Frequency response is checked by verifying the bandwidth using the Leveled Sine Wave function. A leveled sine wave is monitored until the -3 dB point is observed on the oscilloscope.
- Horizontal deflection characteristics are verified by calibrating the time base using the Time Marker function. This calibration procedure is similar to the one for verifying the vertical deflection characteristics, except that it checks the horizontal axis.
- The oscilloscope's ability to trigger on different waveforms is checked using the Wave Generator function.

The menus that implement these functions also include parameters for altering the way the output signal responds to voltage, frequency, and time settings, giving you control of the signal during calibration, and providing more methods for observing the signal's characteristics.

## 8-77. Oscilloscope Calibration Option Specifications

These specifications apply only to the Oscilloscope Calibration Option. General specifications that apply to the 5520A Calibrator can be found in Chapter 1. The specifications are valid providing the 5520A is operated under the conditions specified in Chapter 1, and has completed a warm-up period of at least twice the length of time the calibrator was powered off, up to a maximum of 30 minutes.

## 8-78. Volt Function Specifications

Volt Function	dc Signal		Square Wave Signal	
	into 50 $\Omega$	into 1 M $\Omega$	into 50 $\Omega$	into 1 M $\Omega$
<b>Amplitude Characteristics</b>				
Range	0 V to $\pm 2.2$ V	0 V to $\pm 33$ V	1.8 mV to 2.2 V p-p	1.8 mV to 105 V p-p [1]
Resolution	<100 V: 4 digits or 10 $\mu$ V, whichever is greater $\geq$ 100 V: 5 digits			
Adjustment Range	Continuous [1]			
1-Year Absolute Uncertainty, tcal $\pm$ 5°C	$\pm$ (0.25% of output + 100 $\mu$ V) [2] [3]			
Sequence	1-2-5 (e.g., 10 mV, 20 mV, 50 mV)			
<b>Square Wave Frequency Characteristics</b>				
Range	10 Hz to 10 kHz			
1-Year Absolute Uncertainty, tcal $\pm$ 5°C	$\pm$ (25 ppm of setting + 15 mHz)			
<b>Typical Aberration</b> within 20 $\mu$ s from leading edge	< (2% of output + 100 $\mu$ V)			
<p>[1] The square wave signal into 1 M<math>\Omega</math> is a positive square wave from 1.8 mV to 55 V p-p. From 95 V to 105 V, its output is a square wave-like signal that alternates between the negative peak and the positive peak, with the centerline at -10 V. Signals between 55 V and 95 V p-p are not available.</p> <p>[2] The uncertainty for 50 <math>\Omega</math> loads does not include the input impedance uncertainty of the oscilloscope. Square wave signals below 4.5 mV p-p have an uncertainty of <math>\pm</math> (0.25% of output + 200 <math>\mu</math>V).</p> <p>[3] Signals from 95 to 105 V p-p have an uncertainty of 0.5% of output in the frequency range 100 Hz to 1 kHz. Typical uncertainty is 1.5% of output for 95 to 105 V p-p signals in the frequency range 10 Hz to 100 Hz, and 0.5% of output in the frequency range 1 kHz to 10 kHz.</p>				

**8-79. Edge Function Specifications**

Edge Characteristics into 50 $\Omega$		1-Year Absolute Uncertainty, $t_{cal} \pm 5^{\circ}\text{C}$
<b>Amplitude</b>		
Range (p-p)	4.5 mV to 2.75 V	$\pm$ (2% of output + 200 $\mu\text{V}$ )
Resolution	4 digits	
Adjustment Range	$\pm$ 10% around each sequence value (indicated below)	
Sequence	5 mV, 10 mV, 25 mV, 50 mV, 100 mV, 250 mV, 500 mV, 1 V, 2.5 V	
<b>Other Edge Characteristics</b>		
Frequency Range	1 kHz to 1 MHz	$\pm$ (25 ppm of setting + 15 mHz)
Rise Time	< 400 ps	
Leading Edge Aberrations	within 10 ns	< (3% of output + 2 mV)
	10 to 30 ns	< (1% of output + 2 mV)
	after 30 ns	< (0.5% of output + 2 mV)
Typical Duty Cycle	45% to 55%	

### 8-80. Leveled Sine Wave Function Specifications

Leveled Sine Wave Characteristics into 50 $\Omega$	Frequency Range		
	50 kHz Reference	50 kHz to 100 MHz	100 to 300 MHz [1]
<b>Amplitude Characteristics</b>			
Range (p-p)	5 mV to 5.5 V [1]		
Resolution	< 100 mV: 3 digits ≥ 100 mV: 4 digits		
Adjustment Range	continuously adjustable		
1-Year Absolute Uncertainty, tcal $\pm$ 5 °C	$\pm$ (2% of output + 200 $\mu$ V)	$\pm$ (3.5% of output + 300 $\mu$ V)	$\pm$ (4% of output + 300 $\mu$ V)
Flatness (relative to 50 kHz)	not applicable	$\pm$ (1.5% of output + 100 $\mu$ V)	$\pm$ (2.0% of output + 100 $\mu$ V)
Short-term Stability	$\leq$ 1% [2]		
<b>Frequency Characteristics</b>			
Resolution	10 Hz	10 kHz [3]	10 kHz
1-Year Absolute Uncertainty, tcal $\pm$ 5 °C	$\pm$ (25 ppm + 15 mHz)	$\pm$ 25 ppm [4]	$\pm$ 25 ppm
<b>Distortion Characteristics</b>			
2nd Harmonic	$\leq$ -35 dBc		
3rd and Higher Harmonics	$\leq$ -40 dBc		
<p>[1] Extended frequency range to 350 MHz is provided, but flatness is not specified. Amplitude is limited to 3 V for frequencies above 250 MHz.</p> <p>[2] Within one hour after reference amplitude setting, provided temperature varies no more than <math>\pm</math> 5°C.</p> <p>[3] At frequencies below 120 kHz, the resolution is 10 Hz. For frequencies between 120 kHz and 999.9 kHz, the resolution is 100 Hz.</p> <p>[4] <math>\pm</math> (25 ppm + 15 mHz) for frequencies of 1 MHz and below.</p>			

**8-81. Time Marker Function Specifications**

Time Marker into 50 Ω	5 s to 100 μs	50 μs to 2 μs	1 μs to 20 ns	10 ns to 2 ns
1-Year Absolute Uncertainty, tcal ± 5° C [3]	±(25 + t*1000) ppm [1]	±(25 + t*15,000) ppm [1]	± 25 ppm	± 25 ppm
Wave Shape	pulsed sawtooth	pulsed sawtooth	pulsed sawtooth	sine
Typical Output level	> 1 V pk	> 1 V pk	> 1 V pk	> 2 V p-p [2]
Sequence (cardinal points)	5-2-1 from 5 s to 2 ns (e.g., 500 ms, 200 ms, 100 ms)			
Adjustment Range	At least ± 10% around each cardinal point.			
Resolution	4 digits			
<p>[1] t is the time in seconds. Examples: At 5 s the uncertainty is 5,025 ppm; At 50 μs the uncertainty is 25.75 ppm.</p> <p>[2] The 2 ns time marker is typically &gt; 0.5 V p-p.</p> <p>[3] Away from the cardinal points, add ±50 ppm to uncertainty.</p>				

**8-82. Wave Generator Specifications**

Wave Generator Characteristics	Square Wave, Sine Wave, and Triangle Wave into 50 Ω or 1 MΩ
<b>Amplitude</b>	
Range	into 1 MΩ: 1.8 mV to 55V p-p into 50 Ω: 1.8 mV to 2.2V p-p
1-Year Absolute Uncertainty, tcal ± 5 °C, 10 Hz to 10 kHz	± (3% of p-p output + 100 μV)
Sequence	1-2-5 (e.g., 10 mV, 20 mV, 50 mV)
Typical DC Offset Range	0 to ± (≥40% of p-p amplitude) [1]
<b>Frequency</b>	
Range	10 Hz to 100 kHz
Resolution	4 or 5 digits depending upon frequency
1-Year Absolute Uncertainty, tcal ± 5°C	± (25 ppm + 15 mHz)
[1] The DC offset plus the wave signal must not exceed 30 V rms.	

**8-83. Trigger Signal Specifications for the Time Marker Function**

Time Marker Period	Division Ratio [1]	Amplitude into 50 $\Omega$ (p-p)	Typical Rise Time
5 to 1 s	off/1	$\geq 1$ V	$\leq 2$ ns
0.5 to 0.1 s	off/1/10	$\geq 1$ V	$\leq 2$ ns
50 ms to 100 ns	off/1/10/100	$\geq 1$ V	$\leq 2$ ns
50 to 10 ns	off/10/100	$\geq 1$ V	$\leq 2$ ns
5 to 2 ns	off/100	$\geq 1$ V	$\leq 2$ ns

[1] Divider is internally limited to prevent trigger output from frequencies that are either lower than 0.2 Hz (5 s period) or higher than 10 MHz.

**8-84. Trigger Signal Specifications for the Edge Function**

Edge Signal Frequency	Division Ratio	Amplitude into 50 $\Omega$ (p-p)	Typical Rise Time
1 kHz to 1 MHz	off/1	$\geq 1$ V	$\leq 2$ ns



## 8-85. Oscilloscope Connections

Using the cable supplied with the Oscilloscope Calibration Option, attach the SCOPE connector on the 5520A to one of the channel connectors on your oscilloscope (see Figure 8-3).

To use the external trigger, attach the TRIG OUT connector on the 5520A to the external trigger connection on your oscilloscope. To use the external trigger and view its signal with the calibration signal, attach the TRIG OUT connector to another channel. See your oscilloscope manual for details on connecting and viewing an external trigger.

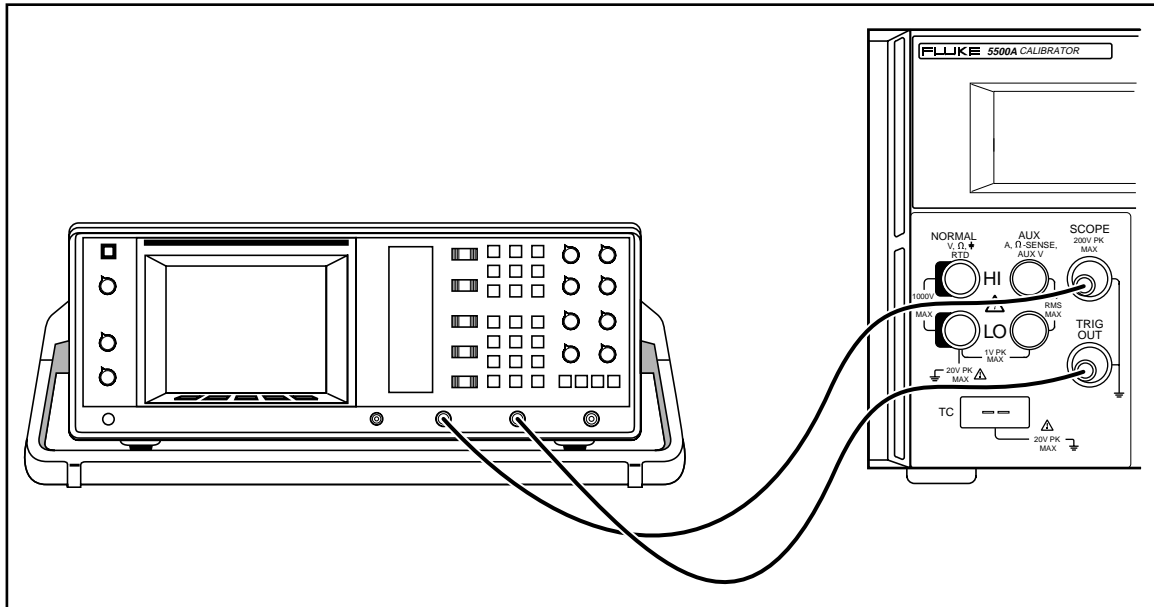

Figure 8-3. Oscilloscope Connection: Channel and External Trigger

g1020f.eps

## 8-86. Starting the Oscilloscope Calibration Option

Press  $\overline{\text{SCOPE}}$  to start the Oscilloscope Calibration Option. The Control Display opens the Volt menu, shown below, which contains options for calibrating the vertical gain on your oscilloscope. This is the first of five calibration menus, which you can scroll through by pressing the softkey under MODE. Each menu is described in detail in this chapter.



g1021i.eps

## 8-87. The Output Signal

The location of the output signal is indicated on the Control Display (the display on the right side). If your 5520A is connected, but the output does not appear on the oscilloscope, you may have the 5520A in standby mode.

The settings for the output signal are indicated in the Output Display (the display on the left side). The following example shows the default settings for Volt mode, which are set when you start the Oscilloscope Calibration Option.

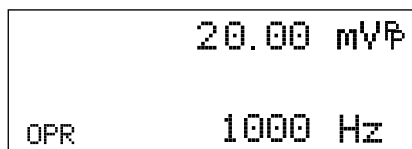

g1022i.eps

If STBY is displayed, press the  $\overline{\text{OPR}}$  key. The Output Display will show OPR and the output should appear on the oscilloscope.

### 8-88. Adjusting the Output Signal

The 5520A provides several ways to change the settings for the output signal during calibration. Since oscilloscope calibration requires many adjustments of the output signal, the three available methods for changing these settings for oscilloscope calibration are summarized below. These methods provide the means of jumping to a new value or sweeping through a range of values.

### 8-89. Keying in a Value

To key a specific value directly into the 5520A from its front panel:

1. Key in the value you want to enter, including the units and prefixes. For example to enter 120 mV press **1** **2** **0**  **$\mu$ <sub>m</sub>**  **$^{dB}$ mV**. The Control Display will show:

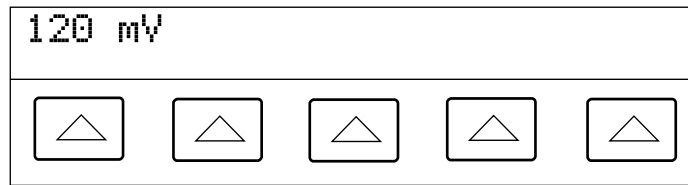

gl002i.eps

#### Note

Units and prefixes printed in purple in the upper left corner of the keys are accessed through the **SHIFT** key. For example, to enter 200  $\mu$ s, press



If you make an error, press **CE** to clear the Control Display and return to the menu.

2. Press **ENTER** to activate the value and move it to the Output Display.

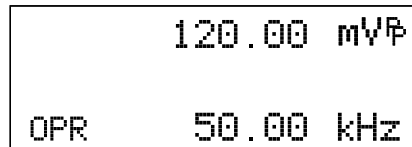

gl0023i.eps

Other settings in the display will remain unaltered unless you key in an entry and specify the units for that setting.

### 8-90. Adjusting Values with the Rotary Knob

To adjust values in the Output Display using the rotary knob:

1. Turn the rotary knob. A cursor appears in the output display under the lowest digit and begins changing that digit. If you wish to place the cursor in the field without changing the digit, press **EDIT FIELD**.

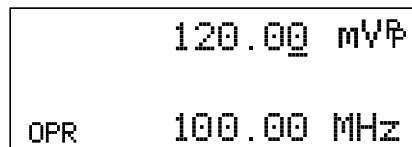

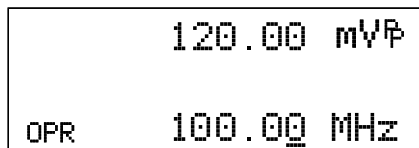

gl003i.eps

2. To move the cursor between the voltage and frequency fields, press **EDIT FIELD**.



120.00 mVp  
OPR 100.00 MHz

gl004i.eps

- Use the  and  keys to move the cursor to the digit you want to change.
- Turn the rotary knob to change the value.

When you use the rotary knob in either Volt mode or Marker mode, the Control Display shows the new value's percentage change from the reference value. This is useful for determining the percentage of error on the oscilloscope. You can set the reference value to the new value by pressing .

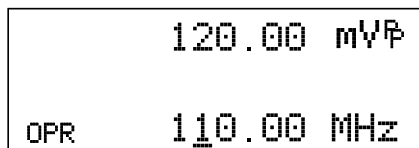

120.00 mVp  
OPR 110.00 MHz



gl005i.eps

- Press  to remove the cursor from the Output Display and save the new value as the reference value.

*Note*



*If you attempt to use the rotary knob to adjust a value to an amount that is invalid for the function you are using, or is outside the value's range limit, the value will not change and the 5520A will beep. If you need to reach a different range of values, turn the knob quickly to jump to the new range.*

**8-91. Using  and **

The  and  keys cause the current value of the signal to jump to a pre-determined cardinal value, whose amount is determined by the current function. These keys are described in more detail under the descriptions for each function.

**8-92. Resetting the Oscilloscope Option**

You can reset all parameters in the 5520A to their default settings at any time during front panel operations by pressing the  key on the front panel.

After resetting the 5500A, press  to return to the Oscilloscope Calibration Option (the Volt menu appears). Press  to reconnect the signal output.

### 8-93. Calibrating the Voltage Amplitude on an Oscilloscope

The oscilloscope voltage gain is calibrated by applying a low frequency square wave signal and adjusting its gain to meet the height specified for different voltage levels, designated by the graticule line divisions on the oscilloscope. The signal is applied from the 5520A in Volt mode. The specific voltages that you should use for calibration, and the graticule line divisions that need to be matched, vary for different oscilloscopes and are specified in your oscilloscope's service manual.

### 8-94. The Volt Function

The Voltage gain is calibrated using the Volt function. This function is accessed through the Volt menu, which appears when you start the SCOPE option, or when you press the softkey under MODE to scroll through the oscilloscope calibration menus.

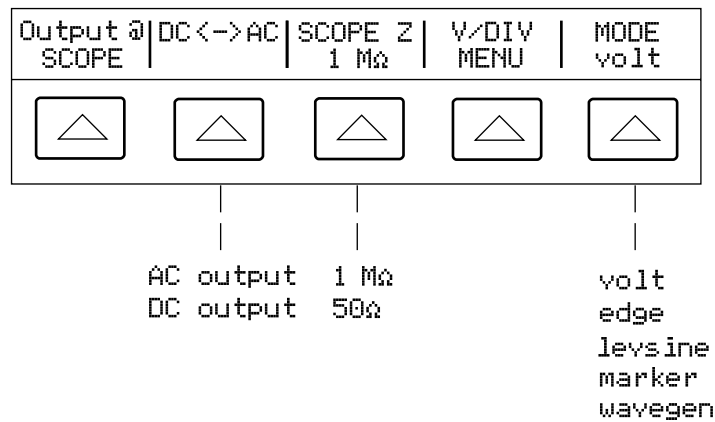

g1024i.eps

Each menu item is described below:

- **OUTPUT @ SCOPE** Indicates the location of the signal output. If the signal does not appear on the oscilloscope, press **[OPR]**. To disconnect the signal, press **[STBY]**.
- **DC <-> AC** Toggles between a dc and ac signal. Pressing the softkey from the ac signal produces the dc equivalent output.
- **SCOPE Z** Toggles the calibrator's output impedance setting between 1 MΩ and 50 Ω.
- **V/DIV MENU** Opens the voltage scaling menu, which lets you select the scale of the signal in volts per division. This menu is described below in detail, under "The V/DIV Menu."
- **MODE** Indicates you are in Volt mode. Use the softkey to change modes and open the corresponding menus for the other four oscilloscope calibration modes.

### 8-95. The V/DIV Menu

The V/DIV menu, shown below, sets the number of volts denoted by each division on the oscilloscope. This menu provides alternative methods for changing the output amplitude that may be more convenient for certain oscilloscope applications. To access the V/DIV menu, press V/DIV from the Volt menu.

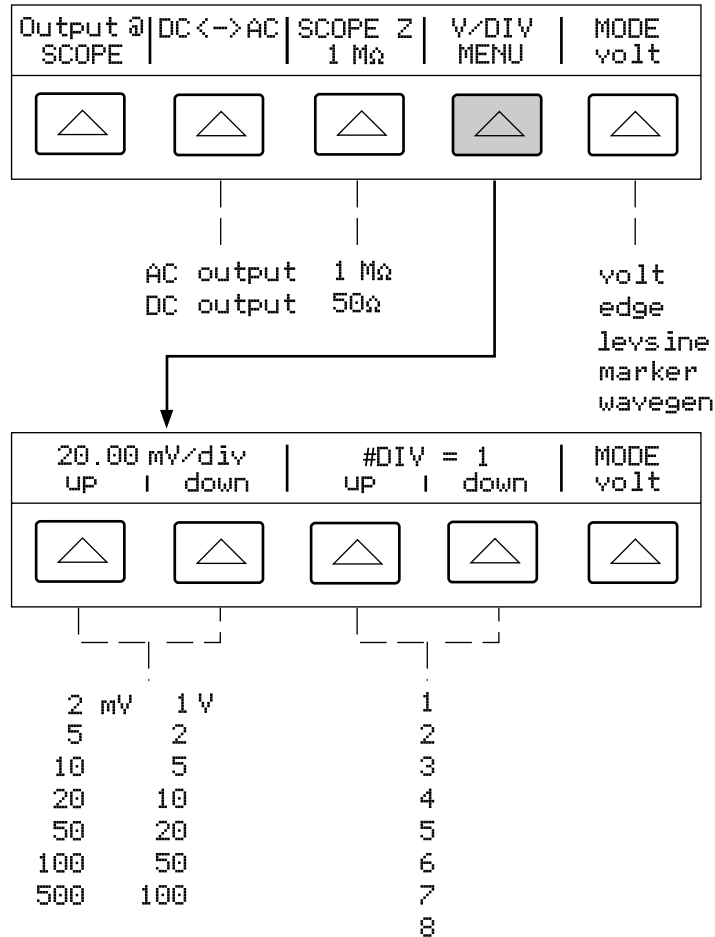

gl025i.eps

Each item in the V/DIV menu is described below.

- **V/div** Changes the scale of the output display by changing the number of volts that are represented by each division. The available settings, shown in the figure above, are provided in 1-2-5 step increments. Press the softkey under UP to increase the volts per division. Press the softkey under DOWN to decrease the volts per division.
- **# DIV** Specifies the number of divisions that establish the peak-to-peak value of the waveform. The value can be adjusted from one to eight divisions. The amount denoted by each division is displayed in the V/div field. Press the softkey under UP to increase the signal's height, and press the softkey under DOWN to decrease it.

### 8-96. Shortcuts for Setting the Voltage Amplitude

The **MULT** and **DIV** keys step the voltages through cardinal point values of an oscilloscope in a 1-2-5 step sequence. For example, if the voltage is 40 mV, then pressing **MULT** increases the voltage to the nearest cardinal point, which is 50 mV. Pressing **DIV** decreases the voltage to the nearest cardinal point, which is 20 mV.

**8-97. Amplitude Calibration Procedure for an Oscilloscope**

This example procedure describes how to use the Volt menu to calibrate the oscilloscope’s amplitude gain. During calibration, you will need to set different voltages and verify that the gain matches the graticule lines on the oscilloscope according to the specifications for your particular oscilloscope. See your oscilloscope manual for the recommended calibration settings and appropriate gain values.

Before you start this procedure, verify that you are running the oscilloscope option in Volt mode. If you are, the Control Display shows the following menu.

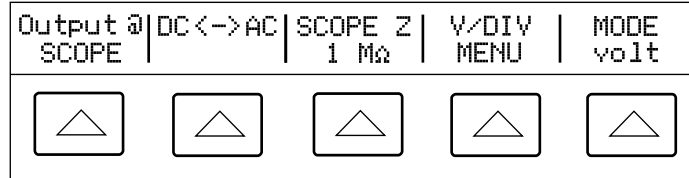

gl026i.eps

Perform the following sample procedure to calibrate the vertical gain.

1. Connect the calibrator to Channel 1 on the oscilloscope, making sure the oscilloscope is terminated at the proper impedance (1 MΩ for this example). Verify that the **OPR** key on the 5520A is lit, indicating that the signal is connected.
2. Key in the voltage level that is recommended for your oscilloscope. For example to enter 20 mV, press **2** **0** **μm** **dBm** **V**, then press **ENTER**. See “Keying in a Value” earlier in this chapter.
3. Adjust the oscilloscope as necessary. The waveform should be similar to the one shown below, with the gain at exactly the amount specified for the calibration settings for your oscilloscope.

This example shows the gain at 20 mV to be 4 divisions, at 5 mV per division.

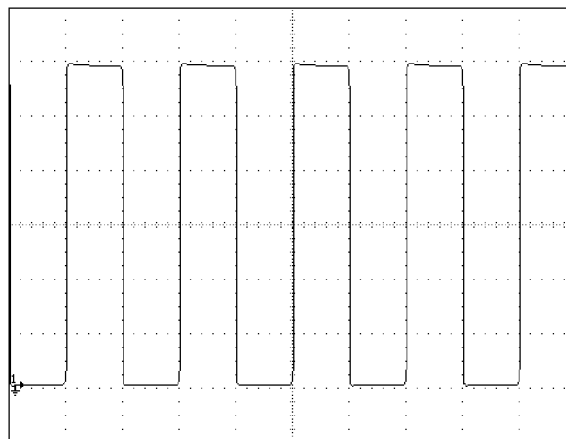

gl006i.bmp

4. Change the voltage to the next value recommended for calibrating your oscilloscope model, and repeat this procedure at the new voltage level, verifying the gain is correct according to the specifications in your manual.
5. Repeat the procedure for each channel.

## 8-98. Calibrating the Pulse and Frequency Response on an Oscilloscope

The pulse response is calibrated with a square-wave signal that has a fast leading edge rise-time. Using this signal, you adjust the oscilloscope as necessary until it meets its particular specifications for rise time and pulse aberrations.

Following pulse verification, the frequency response is checked by applying a leveled sine wave and acquiring a frequency reading at the -3 dB point, when the amplitude drops approximately 30%.

## 8-99. The Edge Function

The Edge function is used for calibrating the pulse response for your oscilloscope. To reach the Edge menu, press the softkey under MODE until “edge” appears.

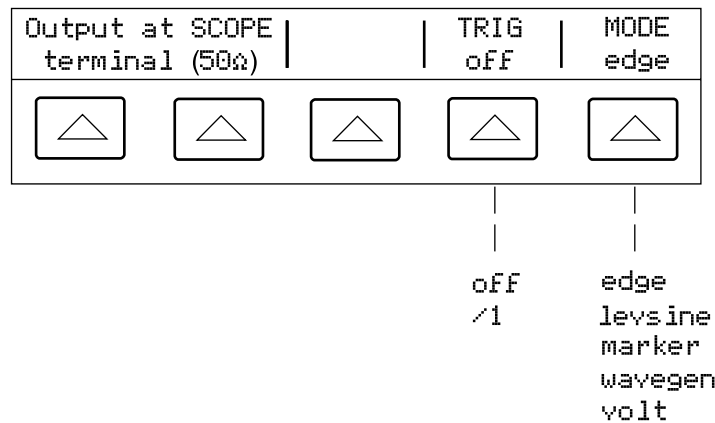

gl027i.eps

Each option in the Edge menu is described below.

- **OUTPUT @ SCOPE terminal (50 Ω)** Indicates the location and impedance of the signal output. If the signal does not appear on the oscilloscope, press **OPR**. To disconnect the signal, press **STBY**.

You cannot change the output impedance in Edge mode.

- **TRIG** If you are using the external trigger, use this key to toggle the trigger off and on. When on, the reading will show “/1” which indicates that the external trigger is at the same frequency as the edge output.

The external trigger can be useful for many digital storage oscilloscopes that have difficulty triggering on fast rise time signals.

You can also toggle the trigger off and on by pressing **TRIG OUT**.

- **MODE** Indicates you are in Edge mode. Use the softkey to change modes and open the corresponding menus for the other four oscilloscope calibration modes.



### 8-100. Pulse Response Calibration Procedure for an Oscilloscope

This sample procedure shows how to check the oscilloscope's pulse response. Before you check your oscilloscope, see your oscilloscope's manual for the recommended calibration settings.

Before you start this procedure, verify that you are running the oscilloscope option in Edge mode. If you are, the Control Display shows the following menu.

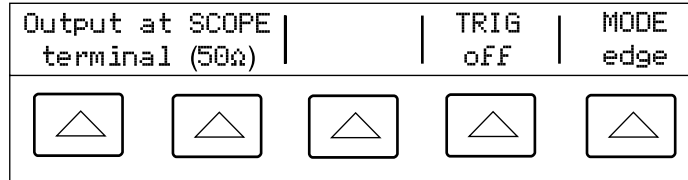

gl028i.eps

Perform the following sample procedure to calibrate the pulse response.

1. Connect the 5520A to Channel 1 on the oscilloscope. Select 50 Ω impedance or use a 50 Ω termination directly at the oscilloscope input. Verify that the **OPR** key is lit, indicating that the signal is connected.
2. Alter the voltage setting for the signal so it matches the amplitude value recommended by your oscilloscope manufacturer for calibrating the edge response. The default setting is 25 mV @ 1 MHz.

For example, on a Fluke PM3392A oscilloscope, start with a signal of 1 V @ 1 MHz.

3. Adjust the scale on your oscilloscope to achieve a good picture of the edge. For example, on a Fluke PM3392A oscilloscope with a 1 V @ 1 MHz signal, use 200 mV/div.
4. Adjust the time base on your oscilloscope to the fastest position available (20.0 or 50.0 ns/div).

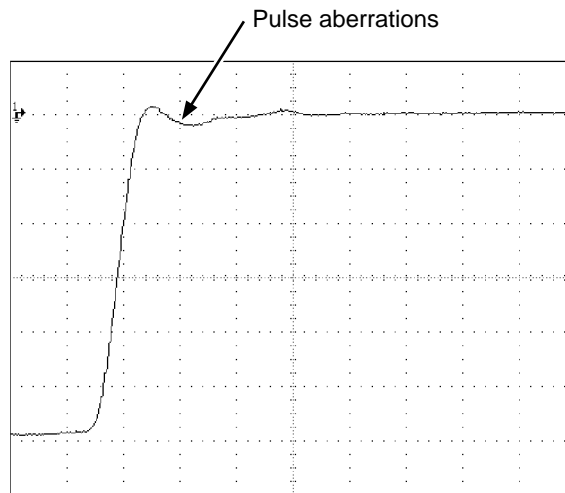

gl007i.eps

5. Verify that your oscilloscope exhibits the proper rise time and pulse aberration characteristics.
6. Remove the input signal by pressing **STBY**.

### 8-101. The Leveled Sine Wave Function

The Leveled Sine Wave (Levsine) function uses a leveled sine wave, whose amplitude remains relatively constant over a range of frequencies, to check the oscilloscope's bandwidth. When you check your oscilloscope, you change the wave's frequency until the amplitude displayed on the oscilloscope drops 30%, which is the amplitude that corresponds to the -3 dB point.

To access the Levsine menu, press the softkey under MODE until "levsine" appears.

*Note*

*Make sure there is no cable connected to TRIG OUT while using the Levsine function..*

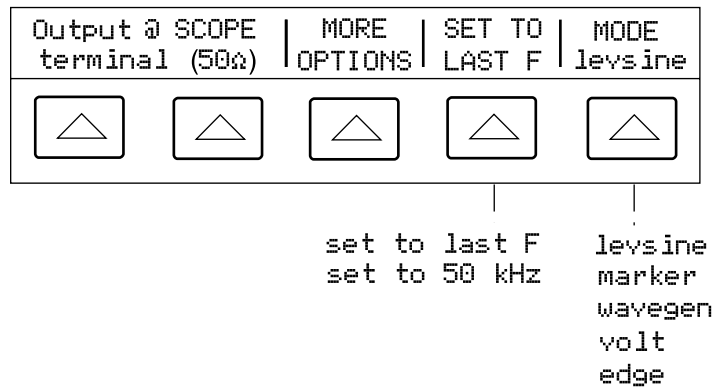

gl029i.eps

Each option in the Levsine menu is described below.

- **OUTPUT @ SCOPE terminal (50 Ω)** Indicates the location and impedance of the signal output. If the signal does not appear on the oscilloscope, press **OPR**. To disconnect the signal, press **STBY**. You cannot change the impedance while you are in Levsine mode.
- **MORE OPTIONS** Opens additional menu items, which are described in detail under "The MORE OPTIONS Menu."
- **SET TO LAST F** Toggles between the current frequency setting and the reference value of 50 kHz. This option is useful for reverting to the reference to check the output after you make adjustments at another frequency.
- **MODE** Indicates you are in Levsine mode. Use the softkey to change modes and open the corresponding menus for the other four calibration modes.

*Note*

*If a question mark appears in the Output Display, then no specifications are available for the frequency you are using. This will occur at frequencies greater than 250 MHz.*

### 8-102. Shortcuts for Setting the Frequency and Voltage

Three options are available for controlling the sine wave settings.

- **SET TO LAST F** toggles between the last frequency used and the reference frequency of 50 kHz, letting you check the output at the reference after you make adjustments at a different frequency.
- **MORE OPTIONS** lets you use an automatic frequency sweep and lock the voltage range, if necessary. The following section provides details on this menu.
- The **MULT** and **DIV** keys step frequencies up or down in amounts that let you quickly access a new set of frequencies. For example, if the value is 250 kHz, **MULT**

changes it to 300 kHz, and  $\boxed{\text{DIV}}_{\pm}$  changes it to 200 kHz. For voltage values,  $\boxed{\text{MULT}}_{\times}$  and  $\boxed{\text{DIV}}_{\pm}$  step through cardinal point values in a 1.2-3-6 sequence.

### 8-103. The MORE OPTIONS Menu

When you select MORE OPTIONS, you open options that give you more control over the frequency and voltage. To access the MORE OPTIONS menu, press the softkey under MORE OPTIONS in the Levsine menu.

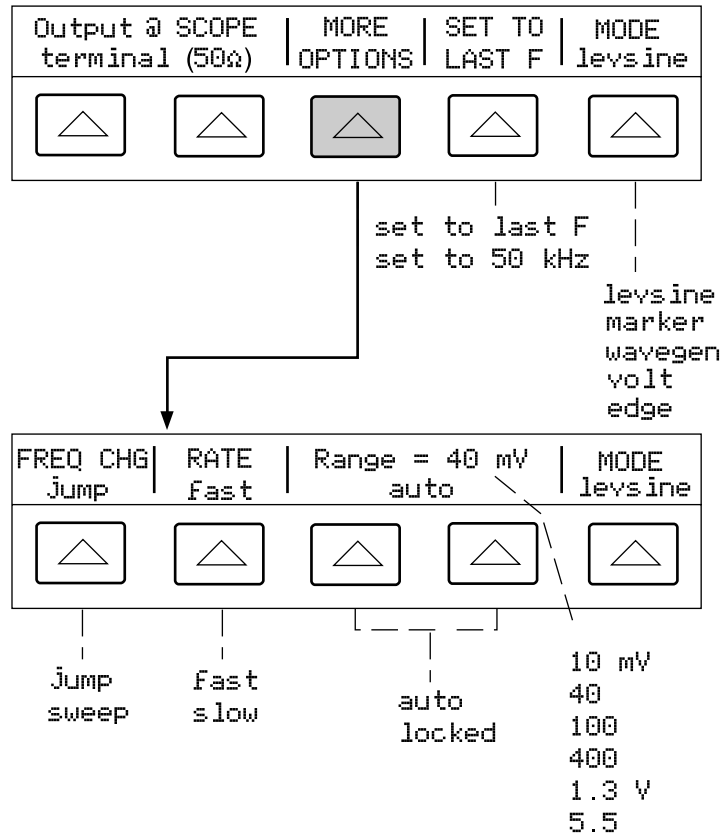

gl030i.eps

Each option in the MORE OPTIONS menu is described below.

- FREQ CHANGE** Toggles between two settings that control the way the output signal adjusts to a new frequency. This is the default setting.

“Jump” causes the output signal to jump immediately to a new frequency setting. “Sweep” causes the signal to sweep through a series of frequency values, over a range you set. Use the sweep function to watch the signal gradually change over a given bandwidth and see the point at which its amplitude changes. Details for using the sweep function are provided under “Sweeping Through a Frequency Range.”
- RATE** Used when FREQ CHANGE is set to “sweep” to toggle the sweep speed between “fast” and “slow.” The slow speed is one tenth the fast speed.

The slow sweep rate lets you watch the frequency change very slowly. After a fast sweep, you may want to pinpoint a certain frequency with a slow sweep over a subset of your previous frequency range.
- RANGE** The softkeys toggle between two settings: “auto,” which adjusts the range limit automatically in accordance with the voltage level, and “locked,” which sets the available voltages to one range.

There are six range limits in Levsine mode: 10 mV, 40 mV, 100 mV, 400 mV, 1.3 V, and 5.5 V. When set to “auto” the calibrator uses your voltage setting to automatically set the range limit that provides the most accurate output. When set to “locked” the range limit remains fixed and you can decrease the voltage down to 0 V within any range limit.

For example, assume the range limit is 40 mV. If you set the 40 mV range to “auto” and then enter 1 mV, the calibrator will adjust the range limit to 10 mV and will output 1 mV from within the 10 mV range. If you set the 40 mV range to “locked” and then enter 1 mV, the calibrator will output 1 mV from within the 40 mV range.

The default range setting is “auto,” which should always be used unless you are troubleshooting discontinuities in your oscilloscope’s vertical gain. The range setting will always return to “auto” after you leave Levsine mode.

**8-104. Sweeping through a Frequency Range**

When you change frequencies using the sweep method, the output sine wave sweeps through a specified range of frequencies, letting you identify the frequency at which the oscilloscope’s signal exhibits certain behavior (e.g., changes amplitude). Before you start this procedure, make sure you are in the MORE OPTIONS menu and the sine wave is displayed on the oscilloscope.

Perform the following procedure to sweep through frequencies.

1. Make sure the output signal shows the starting frequency. If not, key in the starting frequency; then press **ENTER** .
2. Toggle **FREQ CHANGE** to “sweep.” Toggle the **RATE** to “slow” if you want to observe a very slow sweep over a small range.
3. Key in the end frequency; then press **ENTER** .

After you press **ENTER** , the signal sweeps through frequencies between the two values you entered, and the Sweep menu appears on the Control Display as shown below.

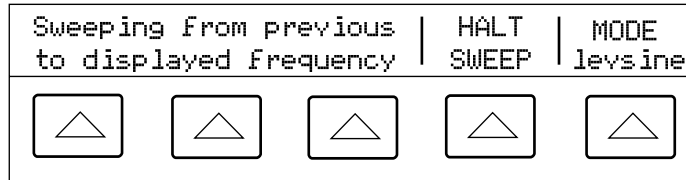

g1031i.eps

4. You can let the signal sweep through the entire range, or you can halt the sweep if you need to record the frequency at a certain point.

To interrupt the sweep, press the softkey under **HALT SWEEP**. The current frequency will appear on the Output Display and the **MORE OPTIONS** menu will reappear on the Control Display.

*Note*

*When you interrupt the frequency sweep by pressing **HALT SWEEP**, the **FREQ CHANGE** method switches back to “jump.”*

5. Repeat the procedure if necessary. For example, if you did a fast sweep, you may want to pinpoint a certain frequency with a slow sweep over a subset of your previous frequency range.

### 8-105. Frequency Response Calibration Procedure for an Oscilloscope

This sample procedure, which verifies the frequency response on your oscilloscope, is usually performed after the pulse response is verified.

This procedure checks the bandwidth by finding the frequency at the -3 dB point for your oscilloscope. The reference sine wave in this procedure has an amplitude of 6 divisions, so that the -3 dB point can be found when the amplitude drops to 4.2 divisions.

Before you start this example procedure, verify that you are running the oscilloscope option in Levsine mode. If you are, the Control Display shows the following menu.

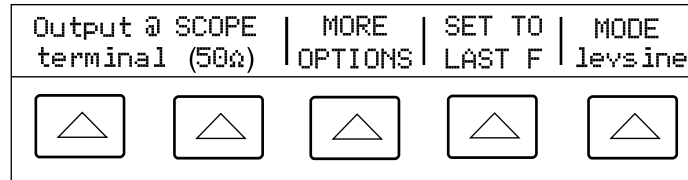

gl032i.eps

Perform the following sample procedure to calibrate the frequency response.

1. Reconnect the signal by pressing the **OPR** key on the 5500A. Select 50  $\Omega$  impedance or use a 50  $\Omega$  external termination directly at the oscilloscope input
2. Adjust the sine wave settings in the Output Display according to the calibration recommendations in your oscilloscope manual. For example, for the Fluke PM3392A oscilloscope, start at 120 mV @ 50 kHz. To enter 120 mV, press **1** **2** **0**  **$\mu$ m**  **$^{dBm}$ V**; then press **ENTER**.
3. Adjust the oscilloscope as necessary. The sine wave should appear at exactly six divisions, peak-to-peak, as shown below.

If necessary, make small adjustments to the voltage amplitude until the wave reaches exactly six divisions. To fine-tune the voltage, press **EDIT FIELD** to bring a cursor into the Output Display, move the cursor with the **←** key, and turn the rotary knob to adjust the value. (See “Fine-Tuning Values” earlier in this chapter.)

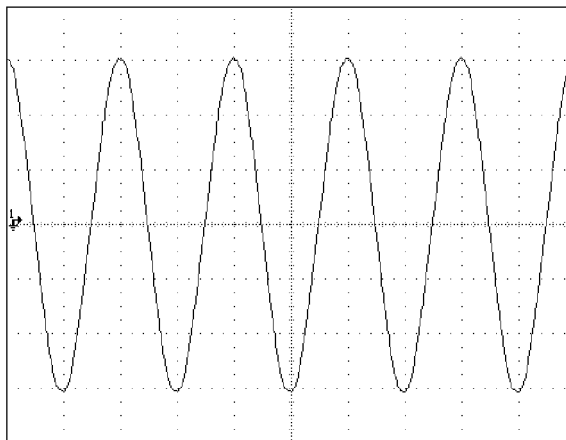

gl009i.bmp

4. Increase the frequency to 60 MHz (for 100-MHz instruments), or 150 MHz (for 200-MHz instruments). To enter 60 MHz, press **6** **0** **M** **Hz**; then press **ENTER**.
5. Continue to increase the frequency slowly until the waveform decreases to 4.2 divisions, as shown below.

To increase the frequency slowly, fine-tune it using the rotary knob. To do this, press **EDIT FIELD** to place a cursor in the Output Display. Press **EDIT FIELD** again to place it in the frequency field, and use the **◀** and **▶** keys to move it to the digit you want to change. Then change the value by turning the rotary knob.

Continue making small increments in the frequency until the signal drops to 4.2 divisions. At 4.2 divisions, the signal is at the frequency that corresponds to the -3 dB point.

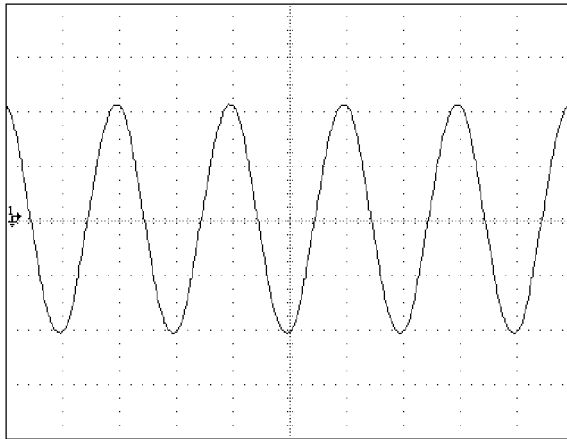

gl010i.bmp

6. Remove the input signal by pressing **STBY**.
7. Repeat this procedure for the remaining channels on your oscilloscope.

## 8-106. Calibrating the Time Base of an Oscilloscope

The horizontal deflection (time base) of an oscilloscope is calibrated using a method similar to the vertical gain calibration. A time marker signal is generated from the 5520A and the signal's peaks are matched to the graticule line divisions on the oscilloscope.

### 8-107. The Time Marker Function

The Time Marker function, which is available through the Marker menu, lets you calibrate the timing response of your oscilloscope. To access the Marker menu, press the softkey under MODE until "marker" appears.

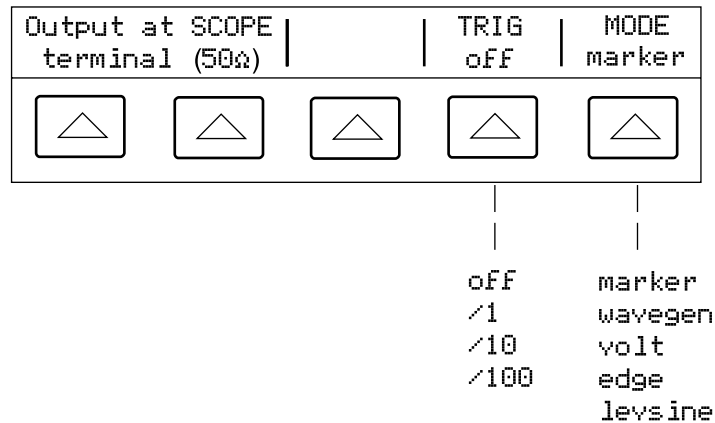

gl033i.eps

Each option in the Marker menu is described below.

- **OUTPUT @ SCOPE terminal** Indicates the location of the signal output. If the signal does not appear on the oscilloscope, press **OPR**. To disconnect the signal, press **STBY**.
- **TRIG** If you are using the external trigger, use this key to cycle through the trigger settings. The available trigger settings are: off, /1 (trigger signal appears on each marker), /10 (trigger signal appears on every tenth marker), and /100 (trigger signal appears at every 100th marker).

You can also toggle the trigger off and on by pressing **TRIG OUT**.

- **MODE** Indicates you are in Marker mode. Use the softkey to change modes and open the corresponding menus for the other four oscilloscope calibration modes.



### 8-108. Time Base Marker Calibration Procedure for an Oscilloscope

This sample procedure uses the Time Marker function to check the horizontal deflection (time base) of your oscilloscope. See your oscilloscope's manual for the exact time base values recommended for calibration.

Before you begin this procedure, verify that you are in Marker mode. If you are, the Control Display shows the following menu.

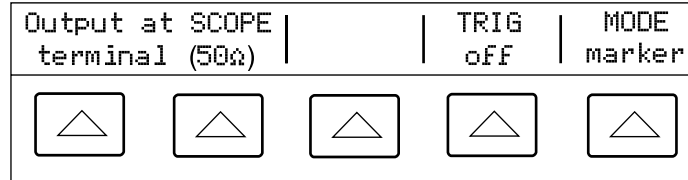

g1034i.eps

Perform the following sample procedure to calibrate the time base.

1. Connect the calibrator to Channel 1 on the oscilloscope. Select 50  $\Omega$  impedance or use an external 50  $\Omega$  termination. Make sure the oscilloscope is dc-coupled.
2. Apply a time marker value according to the recommended calibration settings in your oscilloscope manual. For example, to enter 200 ns, press **2** **0** **0** **SHIFT** **n** **k** **SHIFT** **Hz**, then press **ENTER**.

#### Note

*You may enter the equivalent frequency instead of the time marker value. For example, instead of entering 200 ns, you may enter 5 MHz.*

Set your oscilloscope's time base to show 10 time markers. The time markers should align with the oscilloscope divisions, as shown in the example below. For an accurate reading, align the signal's peaks with the horizontal center axis.

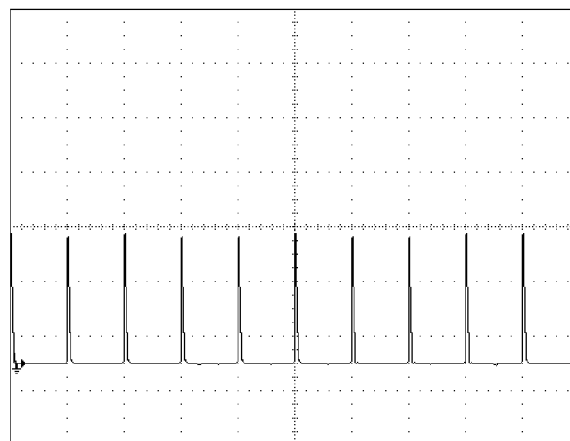

Peaks are aligned with center axis

g1011i.eps

4. Repeat this procedure for all time marker values recommended for your oscilloscope. Repeat for digital and analog mode as required. Some oscilloscopes may need the magnification changed while calibrating in analog mode.
5. Remove the signal by pressing **STBY**.

## 8-109. Testing the Trigger

The oscilloscope's ability to trigger on different waveforms can be tested using the wave generator. When the wave generator is used, a square, sine, or triangle wave is transmitted and the wave's output impedance, offset, and voltage can be varied in order to test the triggering capability at different levels.

### Note

*The wave generator should not be used for checking the accuracy of your oscilloscope. The question mark in the Output Display indicates the amplitude values are not accurate enough to use for checking the oscilloscope's accuracy.*

The wave generator is available through the Wavegen menu, shown below. To access this menu, press the softkey under MODE until "wavegen" appears.

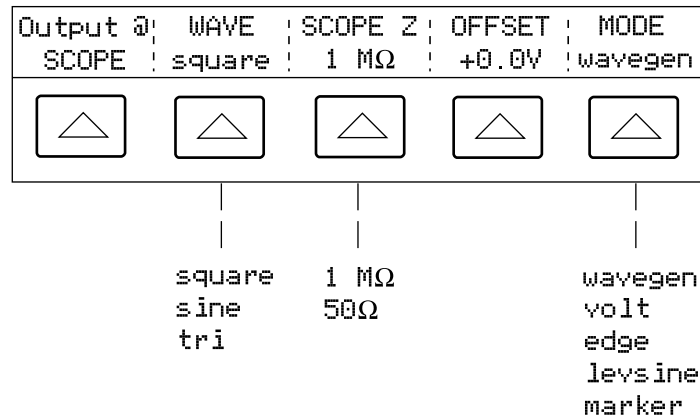

g1035i.eps

Each option in the Wavegen menu is described below.

- **OUTPUT @ SCOPE** Indicates the location of the signal output. If the signal does not appear on the oscilloscope, press **OPR**. To disconnect the signal, press **STBY**.
- **WAVE** Scrolls through the three types of waveforms that are available. You can select a square, sine, or triangle wave as the output.
- **SCOPE Z** Toggles the calibrator's output impedance setting between 50 Ω and 1 MΩ.
- **OFFSET** Displays the offset of the generated wave. To change the offset, key in the new value, and press **ENTER**. Using the rotary knob does not change the offset; it changes the actual voltage output.

When you change the offset, you must remain within certain limits to avoid clipping the peaks. The limit depends on the wave's peak-to-peak value. Specifically, the maximum peak excursion equals the offset plus half of the wave's peak-to-peak value. See "Wave Generator Specifications" at the beginning of this chapter.

- **MODE** Indicates you are in Wavegen mode. Use the softkey to change modes and open the corresponding menus for the other four oscilloscope calibration modes.

## 8-110. Summary of Commands and Queries

This section describes commands and queries that are used specifically for the oscilloscope calibration option. Each command description indicates whether it can be used with IEEE-488 and RS-232 remote interfaces and identifies it as a Sequential, Overlapped, or Coupled command.

**IEEE-488 (GPIB) and RS-232 Applicability**  IEEE-488  RS-232 Each command and query have a check box indicating applicability to IEEE-488 (general purpose interface bus, or GPIB) and RS-232 remote operations.

**Sequential Commands**  Sequential Commands executed immediately as they are encountered in the data stream are called sequential commands. For more information, see “Sequential Commands” in Chapter 5.

**Overlapped Commands**  Overlapped Commands SCOPE, TRIG, and OUT\_IMP are designated as overlapped commands because they may be overlapped (interrupted) by the next command before they have completed execution. When an overlapped command is interrupted, it may take longer to execute while it waits for other commands to be completed. To prevent an overlapped command from being interrupted during execution, use \*OPC, \*OPC?, or \*WAI . These commands prevent interruptions until they detect the command’s completion. For more information, see “Overlapped Commands” in Chapter 5.

**Coupled Commands**  Coupled SCOPE and OUT\_IMP are coupled commands because they can be coupled (combined) with other commands to form a compound command sequence. Care must be taken to ensure that commands are not coupled in a way that may cause them to disable each other, since this may result in a fault. For more information, see “Coupled Commands” in Chapter 5.

**SCOPE**  IEEE-488  RS-232  Sequential  Overlapped  Coupled

Programs the 5500A-SC oscilloscope calibration hardware, if installed. The instrument settings are determined by this command's parameter. Once in SCOPE mode, use the OUT command to program new output.

OPER, STBY, \*OPC, \*OPC?, and \*WAI all operate as described in Chapter 6. The state of the oscilloscope's output while in SCOPE mode is reflected by the bit in the ISR that is assigned to SETTLED.

The FUNC? query returns SDCV, SACV, LEVSINE, MARKER, EDGE, and WAVEGEN for the corresponding oscilloscope modes.

Parameters:	OFF	Turns the oscilloscope hardware off. Programs 0 V, 0 Hz, output at the NORMAL terminals, standby.
	VOLT	Oscilloscope's ac and dc voltage mode. Programs 20 mV peak-to-peak, 1 kHz, output at the SCOPE BNC, output impedance 1 MΩ, standby if from OFF or previously in standby.
	EDGE	Oscilloscope Edge mode. Programs 25 mV peak-to-peak, 1 MHz, output at the SCOPE BNC, standby if from OFF or previously in standby.
	LEVSINE	Oscilloscope-leveled sine mode. Programs 30 mV peak-to-peak, 50 kHz, output at the SCOPE BNC, standby if from OFF or previously in standby.
	MARKER	Oscilloscope Marker mode. Programs the period to 1 ms, output at the SCOPE BNC, standby if from OFF or previously in standby.
	WAVEGEN	Oscilloscope Wavegen mode. Programs 20 mV peak-to-peak, square wave, 1 kHz, no offset, output impedance 1 MΩ, standby if from OFF or previously in standby.

Example:	SCOPE VOLT;	OUT -2V, 0 Hz	(dc voltage, -2 V)
	SCOPE VOLT;	OUT 4V, 1 kHz	(ac voltage, 4 V peak-to-peak, 1 kHz.)
	SCOPE EDGE;	OUT 0.5V, 5 kHz	(Edge, 0.5 V peak-to-peak, 5 kHz.)
	SCOPE LEVSINE;	OUT 1V, 20 kHz	(Leveled sine wave, 2 V peak-to-peak, 20 kHz.)
	SCOPE MARKER;	OUT 2 MS	(Marker, period of 2 ms.)
	SCOPE WAVEGEN;	OUT 1V, 1 kHz	(Wave Generator, 1 V peak-to-peak, 1 kHz.)

**SCOPE?**  IEEE-488  RS-232  Sequential  Overlapped  Coupled

Returns the oscilloscope's current mode of operation. Returns OFF if the oscilloscope is off.

Parameter: (None)

Response: <character> (Returns OFF, VOLT, EDGE, LEVSINE, MARKER, or WAVEGEN.)

---

**TRIG**  IEEE-488  RS-232  Sequential  Overlapped  Coupled

Programs the oscilloscope's trigger output BNC.

Parameters: OFF (Turns the trigger output off.)  
 DIV1 (Turns the trigger output on. Frequency is the same as the signal at SCOPE output.)  
 DIV10 (Turns the trigger output on. Frequency is 1/10 of the signal at SCOPE output.)  
 DIV100 (Turns the trigger output on. Frequency is 1/100 of the signal at SCOPE output.)

---

**TRIG?**  IEEE-488  RS-232  Sequential  Overlapped  Coupled

Returns the output setting of the oscilloscope's trigger.

Parameters: (None)

Response: <character> (Returns OFF, DIV1, DIV10, or DIV100.)

---

**OUT\_IMP**  IEEE-488  RS-232  Sequential  Overlapped  Coupled

Programs the oscilloscope's output impedance.

Parameters: Z50 (Programs the oscilloscope's output impedance to 50  $\Omega$ .)  
 Z1M (Programs the oscilloscope's output impedance to 1 M $\Omega$ .)

---

**OUT\_IMP?**  IEEE-488  RS-232  Sequential  Overlapped  Coupled

Returns the impedance setting of the oscilloscope's output.

Parameters: (None)

## 8-111. Verification Tables

Before the 5520A Scope Cal Option leaves the Fluke factory, it is verified to meet its specifications at the following test points. The verification test points are provided here as a guide when re-verification is desired.

### 8-112. Voltage Function Verification: AC Voltage into a 1 M $\Omega$ Load

Nominal Value (p-p)	Frequency	Measured Value (p-p)	Deviation (mV)	1-Year Spec. (mV)
5.0 mV	10 Hz			0.11
5.0 mV	100 Hz			0.11
5.0 mV	1 kHz			0.11
5.0 mV	5 kHz			0.11
5.0 mV	10 kHz			0.11
10.0 mV	10 kHz			0.12
20.0 mV	100 Hz			0.15
20.0 mV	1 kHz			0.15
20.0 mV	10 kHz			0.15
50.0 mV	10 kHz			0.23
89.0 mV	10 Hz			0.32
89.0 mV	10 kHz			0.32
100.0 mV	10 kHz			0.35
200.0 mV	100 Hz			0.60
200.0 mV	1 kHz			0.60
200.0 mV	10 kHz			0.60
500.0 mV	10 kHz			1.35
890.0 mV	10 Hz			2.32
890.0 mV	10 kHz			2.32
1.0 V	100 Hz			2.60
1.0 V	1 kHz			2.60
1.0 V	10 kHz			2.60
2.0 V	10 kHz			5.10
5.0 V	10 Hz			12.60
5.0 V	10 kHz			12.60
10.0 V	10 kHz			25.10
20.0 V	10 kHz			50.10

**Voltage Function Verification: AC Voltage into a 1 M $\Omega$  Load (cont.)**

Nominal Value (p-p)	Frequency	Measured Value (p-p)	Deviation (mV)	1-Year Spec. (mV)
50.0 V	10 Hz			125.10
50.0 V	100 Hz			125.10
50.0 V	1 kHz			125.10
50.0 V	10 kHz			125.10
105.0 V	100 Hz			262.60
105.0 V	1 kHz			262.60

**8-113. Voltage Function Verification: AC Voltage into a 50  $\Omega$  Load**

Nominal Value (p-p)	Frequency	Measured Value (p-p)	Deviation (mV)	1-Year Spec. (mV)
5.0 mV	10 Hz			0.11
5.0 mV	100 Hz			0.11
5.0 mV	1 kHz			0.11
5.0 mV	5 kHz			0.11
5.0 mV	10 kHz			0.11
10.0 mV	100 Hz			0.12
10.0 mV	1 kHz			0.12
10.0 mV	10 kHz			0.12
20.0 mV	10 kHz			0.15
44.9 mV	10 Hz			0.21
44.9 mV	10 kHz			0.21
50.0 mV	10 kHz			0.23
100.0 mV	100 Hz			0.35
100.0 mV	1 kHz			0.35
100.0 mV	10 kHz			0.35
200.0 mV	10 kHz			0.60
449.0 mV	10 Hz			1.22
449.0 mV	10 kHz			1.22
500.0 mV	10 kHz			1.35
1.0 V	100 Hz			2.60
1.0 V	1 kHz			2.60
1.0 V	10 kHz			2.60
2.0 V	10 Hz			5.10

**Voltage Function Verification: AC Voltage into a 50  $\Omega$  Load (cont.)**

Nominal Value (p-p)	Frequency	Measured Value (p-p)	Deviation (mV)	1-Year Spec. (mV)
2.0 V	100 Hz			5.10
2.0 V	1 kHz			5.10
2.0 V	5 kHz			5.10
2.0 V	10 kHz			5.10

**8-114. Voltage Function Verification: DC Voltage into a 50  $\Omega$  Load**

Nominal Value (dc)	Measured Value (dc)	Deviation (mV)	1-Year Spec. (mV)
0.0 mV			0.10
5.0 mV			0.11
-5.0 mV			0.11
10.0 mV			0.12
-10.0 mV			0.12
22.0 mV			0.15
-22.0 mV			0.15
25.0 mV			0.16
-25.0 mV			0.16
55.0 mV			0.24
-55.0 mV			0.24
100.0 mV			0.35
-100.0 mV			0.35
220.0 mV			0.65
-220.0 mV			0.65
250.0 mV			0.72
-250.0 mV			0.72
550.0 mV			1.47
-550.0 mV			1.47
700.0 mV			1.85
-700.0 mV			1.85
2.2 V			5.60
-2.2 V			5.60



**8-115. Voltage Function Verification: DC Voltage into a 1 M $\Omega$  Load**

Nominal Value (dc)	Measured Value (dc)	Deviation (mV)	1-Year Spec. (mV)
0.0 mV			0.10
5.0 mV			0.11
-5.0 mV			0.11
22.0 mV			0.15
-22.0 mV			0.15
25.0 mV			0.16
-25.0 mV			0.16
45.0 mV			0.21
-45.0 mV			0.21
50.0 mV			0.23
-50.0 mV			0.23
220.0 mV			0.65
-220.0 mV			0.65
250.0 mV			0.72
-250.0 mV			0.72
450.0 mV			1.22
-450.0 mV			1.22
500.0 mV			1.35
-500.0 mV			1.35
3.3 V			8.35
-3.3 V			8.35
4.0 V			10.10
-4.0 V			10.10
33.0 V			82.60
-33.0 V			82.60

**8-116. Edge Function Verification**

Nominal Value (p-p)	Frequency	Pulse Response Time ( $\eta$ s)	1-Year Spec. (ps)
25.0 mV	1 MHz		400
250.0 mV	1 MHz		400
250.0 mV	10 kHz		400
250.0 mV	100 kHz		400
250.0 mV	1 MHz		400
2.5 V	1 MHz		400

**8-117. Wave Generator Function Verification: 1 M $\Omega$  Load**

Waveform	Nominal Value (p-p)	Frequency	Measured Value (p-p)	Deviation (mV)	1-Year Spec. (mV)
Square	5.0 mV	10 kHz			0.25 mV
Square	20.0 mV	10 kHz			0.70 mV
Square	89.0 mV	10 kHz			2.77 mV
Square	219.0 mV	10 kHz			6.67 mV
Square	890.0 mV	10 kHz			26.80 mV
Square	6.5 V	10 kHz			195.10 mV
Square	55.0 V	10 kHz			1.65 V
Sine	5.0 mV	10 kHz			0.25 mV
Sine	20.0 mV	10 kHz			0.70 mV
Sine	89.0 mV	10 kHz			2.77 mV
Sine	219.0 mV	10 kHz			6.67 mV
Sine	890.0 mV	10 kHz			26.80 mV
Sine	6.5 V	10 kHz			195.10 mV
Sine	55.0 V	10 kHz			1.65 V
Triangle	5.0 mV	10 kHz			0.25 mV
Triangle	20.0 mV	10 kHz			0.70 mV
Triangle	89.0 mV	10 kHz			2.77 mV
Triangle	219.0 mV	10 kHz			6.67 mV
Triangle	890.0 mV	10 kHz			26.80 mV
Triangle	6.5 V	10 kHz			195.10 mV
Triangle	55.0 V	10 kHz			1.65 V

**8-118. Wave Generator Function Verification: 50  $\Omega$  Load**

Waveform	Nominal Value (p-p)	Frequency	Measured Value (p-p)	Deviation (mV)	1-Year Spec. (mV)
Square	5.0 mV	10 kHz			0.25 mV
Square	10.9 mV	10 kHz			0.43 mV
Square	44.9 mV	10 kHz			1.45 mV
Square	109.0 mV	10 kHz			3.37 mV
Square	449.0 mV	10 kHz			13.57 mV
Square	1.1 V	10 kHz			32.50 mV
Square	2.2 V	10 kHz			66.10 mV
Sine	5.0 mV	10 kHz			0.25 mV
Sine	10.9 mV	10 kHz			0.43 mV
Sine	44.9 mV	10 kHz			1.45 mV
Sine	109.0 mV	10 kHz			3.37 mV
Sine	449.0 mV	10 kHz			13.57 mV
Sine	1.1 V	10 kHz			32.50 mV
Sine	2.2 V	10 kHz			66.10 mV
Triangle	5.0 mV	10 kHz			0.25 mV
Triangle	10.9 mV	10 kHz			0.43 mV
Triangle	44.9 mV	10 kHz			1.45 mV
Triangle	109.0 mV	10 kHz			3.37 mV
Triangle	449.0 mV	10 kHz			13.57 mV
Triangle	1.1 V	10 kHz			32.50 mV
Triangle	2.2 V	10 kHz			66.10 mV

**8-119. Leveled Sinewave Function Verification: Amplitude**

Nominal Value (p-p)	Frequency	Measured Value (p-p)	Deviation (mV)	1-Year Spec. (mV)
5.0 mV	50 kHz			0.300
10.0 mV	50 kHz			0.400
20.0 mV	50 kHz			0.600
40.0 mV	50 kHz			1.000
50.0 mV	50 kHz			1.200
100.0 mV	50 kHz			2.200
200.0 mV	50 kHz			4.200

**Leveled Sinewave Function Verification: Amplitude (cont.)**

Nominal Value (p-p)	Frequency	Measured Value (p-p)	Deviation (mV)	1-Year Spec. (mV)
400.0 mV	50 kHz			8.200
500.0 mV	50 kHz			1.200
1.3 V	50 kHz			26.200
2.0 V	50 kHz			40.200
5.5 V	50 kHz			110.200

**8-120. Leveled Sinewave Function Verification: Flatness**

Nominal Value (p-p)	Frequency	Measured Value (p-p)	Deviation (mV)	1-Year Spec. (mV)
5.0 mV	500 kHz			0.17
5.0 mV	1 MHz			0.17
5.0 mV	1 MHz			0.17
5.0 mV	2 MHz			0.17
5.0 mV	5 MHz			0.17
5.0 mV	10 MHz			0.17
5.0 mV	20 MHz			0.17
5.0 mV	50 MHz			0.17
5.0 mV	100 MHz			0.17
5.0 mV	125 MHz			0.20
5.0 mV	160 MHz			0.20
5.0 mV	200 MHz			0.20
5.0 mV	220 MHz			0.20
5.0 mV	235 MHz			0.20
5.0 mV	250 MHz			0.20
10.0 mV	500 kHz			0.25
10.0 mV	1 MHz			0.25
10.0 mV	1 MHz			0.25
10.0 mV	2 MHz			0.25
10.0 mV	5 MHz			0.25
10.0 mV	10 MHz			0.25
10.0 mV	20 MHz			0.25
10.0 mV	50 MHz			0.25
10.0 mV	100 MHz			0.25
10.0 mV	125 MHz			0.30

**Leveled Sinewave Function Verification: Flatness (cont.)**

Nominal Value (p-p)	Frequency	Measured Value (p-p)	Deviation (mV)	1-Year Spec. (mV)
10.0 mV	160 MHz			0.30
10.0 mV	200 MHz			0.30
10.0 mV	220 MHz			0.30
10.0 mV	235 MHz			0.30
10.0 mV	250 MHz			0.30
40.0 mV	500 kHz			0.70
40.0 mV	1 MHz			0.70
40.0 mV	1 MHz			0.70
40.0 mV	2 MHz			0.70
40.0 mV	5 MHz			0.70
40.0 mV	10 MHz			0.70
40.0 mV	20 MHz			0.70
40.0 mV	50 MHz			0.70
40.0 mV	100 MHz			0.70
40.0 mV	125 MHz			0.90
40.0 mV	160 MHz			0.90
40.0 mV	200 MHz			0.90
40.0 mV	220 MHz			0.90
40.0 mV	235 MHz			0.90
40.0 mV	250 MHz			0.90
100.0 mV	500 kHz			1.60
100.0 mV	1 MHz			1.60
100.0 mV	1 MHz			1.60
100.0 mV	2 MHz			1.60
100.0 mV	5 MHz			1.60
100.0 mV	10 MHz			1.60
100.0 mV	20 MHz			1.60
100.0 mV	50 MHz			1.60
100.0 mV	100 MHz			1.60
100.0 mV	125 MHz			2.10
100.0 mV	160 MHz			2.10
100.0 mV	200 MHz			2.10

**Leveled Sinewave Function Verification: Flatness (cont.)**

Nominal Value (p-p)	Frequency	Measured Value (p-p)	Deviation (mV)	1-Year Spec. (mV)
100.0 mV	220 MHz			2.10
100.0 mV	235 MHz			2.10
100.0 mV	250 MHz			2.10
400.0 mV	500 kHz			6.10
400.0 mV	1 MHz			6.10
400.0 mV	1 MHz			6.10
400.0 mV	2 MHz			6.10
400.0 mV	5 MHz			6.10
400.0 mV	10 MHz			6.10
400.0 mV	20 MHz			6.10
400.0 mV	50 MHz			6.10
400.0 mV	100 MHz			6.10
400.0 mV	125 MHz			8.10
400.0 mV	160 MHz			8.10
400.0 mV	200 MHz			8.10
400.0 mV	220 MHz			8.10
400.0 mV	235 MHz			8.10
400.0 mV	250 MHz			8.10
1.3 V	500 kHz			19.60
1.3 V	1 MHz			19.60
1.3 V	1 MHz			19.60
1.3 V	2 MHz			19.60
1.3 V	5 MHz			19.60
1.3 V	10 MHz			19.60
1.3 V	20 MHz			19.60
1.3 V	50 MHz			19.60
1.3 V	100 MHz			19.60
1.3 V	125 MHz			26.10
1.3 V	160 MHz			26.10
1.3 V	200 MHz			26.10
1.3 V	220 MHz			26.10
1.3 V	235 MHz			26.10

**Leveled Sinewave Function Verification: Flatness (cont.)**

Nominal Value (p-p)	Frequency	Measured Value (p-p)	Deviation (mV)	1-Year Spec. (mV)
1.3 V	250 MHz			26.10
5.5 V	500 kHz			82.5
5.5 V	1 MHz			82.5
5.5 V	1 MHz			82.5
5.5 V	2 MHz			82.5
5.5 V	5 MHz			82.5
5.5 V	10 MHz			82.5
5.5 V	20 MHz			82.5
5.5 V	50 MHz			82.5
5.5 V	100 MHz			82.5
5.5 V	125 MHz			110.00
5.5 V	160 MHz			110.00
5.5 V	200 MHz			110.00
5.5 V	220 MHz			110.00
5.5 V	235 MHz			110.00
5.5 V	250 MHz			110.00

**8-121. Leveled Sinewave Function Verification: Frequency**

Nominal Value (p-p)	Frequency	Measured Frequency	Deviation	1-Year Spec.
1.3 V	50 kHz			0.0013 kHz
1.3 V	10 MHz			0.0003 MHz
1.3 V	250 MHz			0.0063 MHz

**8-122. Marker Generator Function Verification**

Nominal Interval	Measured Interval	Deviation	1-Year Spec.
4.98 s			25.12 ms
2.00 s			4.05 ms
999.21 ms			1.03 ms
500.00 ms			262.50 $\mu$ s
200.00 ms			45.00 $\mu$ s
100.00 ms			12.50 $\mu$ s
50.00 ms			3.75 $\mu$ s
20.00 ms			900.000 ns
10.00 ms			350.00 ns
5.00 ms			150.00 ns
2.00 ms			54.000 ns
1.00 ms			26.000 ns
500.00 $\mu$ s			12.750 ns
200.00 $\mu$ s			5.040 ns
100.00 $\mu$ s			2.510 ns
50.00 $\mu$ s			1.287 ns
20.00 $\mu$ s			0.506 ns
10.00 $\mu$ s			0.252 ns
5.00 $\mu$ s			0.125 ns
2.00 $\mu$ s			0.050 ns
1.00 $\mu$ s			0.025 ns
500.000 ns			0.013 ns
200.000 ns			5.000 ps
100.000 ns			2.500 ps
50.000 ns			1.250 ps
20.000 ns			0.500 ps
10.000 ns			0.250 ps
5.000 ns			0.125 ps
2.000 ns			0.050 ps



# **Chapter 9**

## **Accessories**

	<b>Title</b>	<b>Page</b>
9-1.	Introduction.....	9-3
9-2.	Rack Mount Kit .....	9-4
9-3.	IEEE-488 Interface Cables .....	9-4
9-4.	RS-232 Null-Modem Cables.....	9-4
9-5.	RS-232 Modem Cables .....	9-4
9-6.	5500A/LEADS.....	9-4
9-7.	5725A Amplifier Accessory .....	9-4



## 9-1. Introduction

Table 9-1 summarizes the available models, options and accessories, including cables and components.

**Table 9-1. Options and Accessories**

Model	Description
105780	5500A Getting Started Guide
105783	5500A Programming Reference Guide
105798	5500A Service Manual
5500/CAL	Calibration Software (RS-232 interface)
5500A-SC	Oscilloscope Calibration Option
5500A/CASE	5500A Transit Case for calibrator
5500A/HNDL	5500A Side Handle for transporting the calibrator
5500A/LEADS	5500A Lead Set
5725A	Amplifier
851931	Replacement fuse; 2.5 A/250 V Time Delay (100 V or 120 V line voltage)
851936	Replacement fuse; 1.25 A/250 V Time Delay (200 V or 240 V line voltage)
666339	MET/CAL-IEEE PCI
664828	MET/CAL-IEEE NT
943738	RS-232 Modem Cable, 2.44 m (8 ft) (SERIAL 2 TO UUT) to UUT (DB-9)
945097	5500A Operator Reference Guide
945159	5500A Operator Manual (includes Operator and Programmer Reference Guides)
MET/CAL	Calibration Software (IEEE-488 and RS-232 interface)
MET/TRACK	Metrology Asset Management Software
PM2295/05	IEEE-488 Cable, 0.5 m (1.64 ft)
PM2295/10	IEEE-488 Cable, 1 m (3.28 ft)
PM2295/20	IEEE-488 Cable, 2 m (6.56 ft)
PM8914/001	RS-232 Null Modem Cable, 1.5 m (5 ft) (SERIAL 1 FROM HOST) to PC COM (DB-9)
RS40	RS-232 Null Modem Cable, 1.83 m (6 ft) (SERIAL 1 FROM HOST) to PC COM (DB-25)
TC100	Test Instrument Cart
Y5537	24 in. (61 cm) Rack Mount Kit for 5500A
Y8021	Shielded IEEE-488 Cable 0.5 m (1.64 ft)
Y8022	Shielded IEEE-488 Cable 2 m (6.56 ft)
Y8023	Shielded IEEE-488 Cable 4 m (13 ft)

## **9-2. Rack Mount Kit**

The Y5537 rack mount kit provides all the hardware necessary to mount the 5500A on slides in a 24-inch (61 cm) equipment rack. Instructions are provided in the kit. (To rack mount the 5725A Amplifier, order kit Y5735.)

## **9-3. IEEE-488 Interface Cables**

Shielded IEEE-488 cables are available in three lengths (See Table 9-1). The cables attach to the 5500A to any other IEEE-488 device. Each cable has double 24-pin connectors at both ends to allow stacking. Metric threaded mounting screws are provided with each connector. Appendix D shows the pinout for the IEEE-488 connector.

## **9-4. RS-232 Null-Modem Cables**

The PM8914/001 and RS40 null modem cables connect the 5500A SERIAL 1 FROM HOST port to a printer, video display terminal, computer, or other serial device configured as DTE (Data Terminal Equipment). Appendix D shows the pinouts for the serial connectors.

## **9-5. RS-232 Modem Cables**

The 943738 modem cable connects the 5500A SERIAL 2 TO UUT port to a unit under test serial port (with DB-9 male connector). Appendix D shows the pinouts for the serial connectors.

## **9-6. 5500A/LEADS**

The optional test lead kit, 5500A/LEADS, consists of four high-voltage safety leads (red, black, white, yellow), thermocouple extension wires, thermocouple miniconnectors, and thermocouple measuring “beads.”

## **9-7. 5725A Amplifier Accessory**

The Fluke 5725A Amplifier is an external unit operating under 5500A Calibrator control to extend the volt/hertz and voltage compliance capability of the calibrator. The amplifier adds the following capabilities to the calibrator with no compromise in accuracy:

- Frequency limits at higher voltage increase to 100 kHz at 750 V, 30 kHz at 1100 V.
- Load limit increased to 70 mA for frequencies above 5 kHz
- Capacitive drive increases to 1000 pF, subject to the maximum output current.

A separate set of binding posts on the front panel of the 5725A supplies extended capability. Since most meters have a separate input terminal for the high current ranges, this eliminates the need to change cables during a procedure.

# ***Appendices***

<b>Appendix</b>	<b>Title</b>	<b>Page</b>
A	Glossary.....	A-1
B	ASCII and IEEE-488 Bus Codes.....	B-1
C	RS-232/IEEE-488 Cables and Connectors.....	C-1
D	Creating a Visual Basic Test Program.....	D-1
E	Error Message .....	E-1



# Appendix A

## Glossary

**adc (analog-to-digital converter)**

A device or circuit that converts an analog signal to digital signals.

**absolute uncertainty**

Uncertainty specifications that include the error contributions made by all equipment and standards used to calibrate the instrument. Absolute uncertainty is the numbers to compare with the UUT for determining test uncertainty ratio.

**accuracy**

The degree to which the measured value of a quantity agrees with the true (correct) value of that quantity. For example, an instrument specified to  $\pm 1\%$  uncertainty is 99% accurate.

**apparent power**

The power value obtained by simply multiplying the ac current by the ac voltage on a circuit without consideration of any phase relationship between the two waveforms. (See “true power” for comparison.)

**assert**

To cause a digital signal to go into a logic true state.

**af (audio frequency)**

The frequency range of human hearing; normally 15 - 20,000 Hz.

**artifact standard**

An object that produces or embodies a physical quantity to be standardized, for example a Fluke 732A dc Voltage Reference Standard.

**base units**

Units in the SI system that are dimensionally independent. All other units are derived from base units. The only base unit in electricity is the ampere.

**buffer**

1. An area of digital memory for temporary storage of data.
2. An amplifier stage before the final amplifier.

**burden voltage**

The maximum sustainable voltage across the terminals of a load.

**compliance voltage**

The maximum voltage a constant-current source can supply.

**control chart**

A chart devised to monitor one or more processes to detect the excessive deviation from a desired value of a component or process.

**crest factor**

The ratio of the peak voltage to the rms voltage of a waveform (with the dc component removed).

**dac (digital-to-analog converter)**

A device or circuit that converts a digital waveform to an analog voltage.

**dBm**

A reference power level of 1 mW expressed in decibels.

**derived units**

Units in the SI system that are derived from base units. Volts, ohms, and watts are derived from amperes and other base and derived units.

**displacement power factor**

Refers to the displacement component of power factor; the ratio of the active power of the fundamental wave, in watts, to the apparent power of the fundamental wave, in volt-amperes.

**distortion**

Undesired changes in the waveform of a signal. Harmonic distortion disturbs the original relationship between a frequency and other frequencies naturally related to it. Intermodulation distortion (imd) introduces new frequencies by the mixing of two or more original frequencies. Other forms of distortion are phase distortion and transient distortion.

**errors**

The different types of errors described in this glossary are “offset error,” “linearity error,” “random error,” “scale error,” “systematic errors,” and “transfer error.”

**flatness**

A measure of the variation of the actual output of an ac voltage source at different frequency points when set to the same nominal output level. A flat voltage source exhibits very little error throughout its frequency range.



**floor**

The part of the uncertainty specification of an instrument that is typically a fixed offset plus noise. Floor can be expressed as units, such as microvolts or counts of the least significant digit. For the 5500A, the floor specification is combined with fixed range errors in one term to determine total uncertainty.

**full scale**

The maximum reading of a range of a meter, analog-to-digital converter, or other measurement device, or the maximum attainable output on a range of a calibrator.

**gain error**

Same as scale error. Scale or gain error results when the slope of the meter's response curve is not exactly 1. A meter with only gain error (no offset or linearity error), will read 0V with 0V applied, but something other than 10V with 10V applied.

**ground**

The voltage reference point in a circuit. Earth ground is a connection through a ground rod or other conductor to the earth, usually accessible through the ground conductor in an ac power receptacle.

**ground loops**

Undesirable currents induced when there is more than one chassis ground potential in a system of instruments. Ground loops can be minimized by connecting all instruments in a system to ground to one point.

**guard**

See "voltage guard" and "current guard."

**harmonics**

A waveform that is an integral multiple of the fundamental frequency. For example, a waveform that is twice the frequency of a fundamental is called the second harmonic.

**IPTS-68**

Refers to the International Provisional Temperature Standard (1968), replaced by the International Temperature Standard (1990). This specifies the definition of the °C temperature standard.

**ITS-90**

Refers to the International Temperature Standard (1990), which replaced the International Provisional Temperature Standard (1968). This specifies the definition of the °C temperature standard.

**International Systems of Units**

Same as "SI System of Units," the accepted system of units. See also "units," "base units," and "derived units."

**legal units**

The highest echelon in a system of units, for example the U.S. National Bureau of Standards volt.

**life-cycle cost**

The consideration of all elements contributing to the cost of an instrument throughout its useful life. This includes initial purchase cost, service and maintenance cost, and the cost of support equipment.

**linearity**

The relationship between two quantities when a change in the first quantity is directly proportional to a change in the second quantity.

**linearity error**

Linearity error occurs when the response curve of a meter is not exactly a straight line. This type of error is measured by fixing two points on the response curve, drawing a line through the points, then measuring how far the curve deviates from the straight line at various points in the response curve.

**MAP (Measurement Assurance Program)**

A program for measurement process. A MAP provides information to demonstrate that the total uncertainty of the measurements (data), including both random error and systematic components of error relative to national or other designated standards is quantified, and sufficiently small to meet requirements.

**MTBF (Mean Time Between Failures)**

The time interval in operating hours that can be expected between failure of equipment. MTBF can be calculated from direct observation or mathematically derived through extrapolation.

**MTTF (Mean Time To Fail)**

The time interval in operating hours that can be expected until the first failure of equipment. MTTF can be calculated from direct observation or mathematically derived through extrapolation.

**MTTR (Mean Time to Repair)**

The average time in hours required to repair failed equipment.

**metrology**

The science of, and the field of knowledge concerned with measurement.

**minimum use specifications**

A compilation of specifications that satisfies the calibration requirements of a measurement system or device. The minimum use specifications are usually determined by maintaining a specified test uncertainty ratio between the calibration equipment and the unit under test. The 5500A Service Manual contains a table of minimum use specifications for performing full verification.

**noise**

A signal containing no useful information that is superimposed on a desired or expected signal.

**normal mode noise**

An undesired signal that appears between the terminals of a device.

**offset error**

Same as zero error. The reading shown on a meter when an input value of zero is applied is its offset or zero error.

**parameters**

Independent variables in a measurement process such as temperature, humidity, test lead resistance, etc.

**power factor**

The ratio of actual power used in a circuit, expressed in watts, to the power which is apparently being drawn from the source, expressed in volt-amperes.

**precision**

The precision of a measurement process is the coherence, or the closeness to the one result, of all measurement results. High precision, for example would result in a tight pattern of arrow hits on a target, without respect to where on the target the tight pattern falls.

**predictability**

A measure of how accurately the output value of a device can be assumed after a known time following calibration. If a device is highly stable, it is also predictable. If a device is not highly stable, but its value changes at the same rate every time after calibration, its output has a higher degree of predictability than a device that exhibits random change.

**primary standard**

A standard defined and maintained by some authority and used to calibrate all other secondary standards.

**process metrology**

Tracking the accuracy drift of calibration and other equipment by applying statistical analysis to correction factors obtained during calibration.

**random error**

Any error which varies in an unpredictable manner in absolute value and in sign when measurements of the same value of a quantity are made under effectively identical conditions.

**range**

The stated upper end of a measurement device's span. Usually, however, a measurement device can measure quantities for a specified percentage overrange. (The absolute span including overrange capability is called "scale.") In the 5500A, however, range and scale are identical.

**range calibration**

An optional calibration procedure available to enhance the 5500A specifications by nulling the output to an external standard.

**reference amplifier**

DC voltage references developed for the 5500A. These are 6.9V devices consisting of a zener diode and a transistor. These reference amplifiers exhibit extremely low uncertainty and drift, and are superior to zener diode or temperature-compensated zener diode voltage references.

**reference standard**

The highest-echelon standard in a laboratory; the standard that is used to maintain working standards that are used in routine calibration and comparison procedures.

**relative uncertainty**

5500A uncertainty specifications that exclude the effects of external dividers and standards, for use when range constants are adjusted. Relative uncertainty includes only the stability, temperature coefficient, noise, and linearity specifications of the 5500A itself.

**reliability**

A measure of the “uptime” of an instrument.

**repeatability**

The degree of agreement among independent measurements of a quantity under the same conditions.

**resistance**

A property of a conductor that determines the amount of current that will flow when a given amount of voltage exists across the conductor. Resistance is measured in ohms. One ohm is the resistance through which one volt of potential will cause one ampere of current to flow.

**resolution**

The smallest change in quantity that can be detected by a measurement system or device. For a given parameter, resolution is the smallest increment that can be measured, generated, or displayed.

**rf (radio frequency)**

The frequency range of radio waves; from 150 kHz up to the infrared range.

**rms (root-mean-square)**

The value assigned to an ac voltage or current that results in the same power dissipation in a resistance as a dc current or voltage of the same value.

**rms sensor**

A device that converts ac voltage to dc voltage with great accuracy. RMS sensors operate by measuring the heat generated by a voltage through a known resistance (i.e., power); therefore, they sense true rms voltage.

**resistance temperature detector (RTD)**

A resistance device that provides a proportional resistance output for a temperature of the device. Most RTDs are characterized by their resistance at 0 °C, called the ice point. The most common ice point is 100  $\Omega$  at 0 °C. The curve of resistance vs. temperature can be one of several: pt385 (0.00385 ohms/ohm/°C) and pt3926 (0.003926 ohms/ohm/°C) are examples.

**scale**

The absolute span of the reading range of a measurement device including overrange capability.

**scale error**

Same as gain error. Scale or gain error results when the slope of the meter's response curve is not exactly 1. A meter with only scale error (no offset or linearity error), will read 0V with 0V applied, but something other than 10V with 10V applied.

**secondary standard**

A standard maintained by comparison against a primary standard.

**sensitivity**

The degree of response of a measuring device to the change in input quantity, or a figure of merit that expresses the ability of a measurement system or device to respond to an input quantity.

**shield**

A grounded covering device designed to protect a circuit or cable from electromagnetic interference.

**SI System of Units**

The accepted International System of Units. See also "units," "base units," and "derived units."

**specifications**

A precise statement of the set of requirements satisfied by a measurement system or device.

**stability**

A measure of the freedom from drift in value over time and over changes in other variables such as temperature. Note that stability is not the same as uncertainty.

**standard**

A device that is used as an exact value for reference and comparison.

**standard cell**

A primary cell that serves as a standard of voltage. The term "standard cell" often refers to a "Weston normal cell," which is a wet cell with a mercury anode, a cadmium mercury amalgam cathode, and a cadmium sulfate solution as the electrolyte.

**systematic errors**

Errors in repeated measurement results that remain constant or vary in a predictable way.

**temperature coefficient**

A factor per °C deviation from a nominal value or range that the uncertainty of an instrument increases. This specification is necessary to account for the thermal coefficients in a calibrator's analog circuitry.

**test uncertainty ratio**

The numerical ratio of the uncertainty of the measurement system or device being calibrated to the uncertainty of the measurement system or device used as the calibrator. (Also called "test accuracy ratio.")

**thermal emf**

The voltage generated when two dissimilar metals joined together are heated.

**thermocouple**

Two dissimilar metals that, when welded together, develop a small voltage dependent on the relative temperature between the hotter and colder junction.

**traceability**

The ability to relate individual measurement results to national standards or nationally accepted measurement systems through an unbroken chain of comparisons, i.e., a calibration “audit trail.”

Measurements, measurement systems or devices have traceability to the designated standards if and only if scientifically rigorous evidence is produced in a continuing basis to show that the measurement process is producing measurement results for which the total measurement uncertainty relative to national or other designated standards is qualified.

**transfer error**

The sum of all new errors induced during the process of comparing one quantity against another.

**transfer standard**

Any working standard used to compare a measurement process, system, or device at one location or level with another measurement process, system, or device at another location or level.

**transport standard**

A transfer standard that is rugged enough to allow shipment by common carrier to another location.

**true power**

The actual power (real power) used to produce heat or work. Compare to ‘apparent power.’”

**true value**

Also called legal value, the accepted, consensus, i.e., the correct value of the quantity being measured.

**uncertainty**

The maximum difference between the accepted, consensus, or true value and the measured value of a quantity. Uncertainty is normally expressed in units of ppm (parts per million) or as a percentage.

**units**

Symbols or names that define the measured quantities. Examples of units are: V, mV, A, kW, and dBm. See also “SI System of Units.”

**UUT (Unit Under Test)**

An abbreviated name for an instrument that is being tested or calibrated.

**var**

Symbol for voltampere reactive, the unit of reactive power, as opposed to real power in watts.

**verification**

Checking the functional performance and uncertainty of an instrument or standard without making adjustments to it or changing its calibration constants.

**volt**

The unit of emf (electromotive force) or electrical potential in the SI system of units. One volt is the difference of electrical potential between two points on a conductor carrying one ampere of current, when the power being dissipated between these two points is equal to one watt.

**voltage guard**

A floating shield around voltage measurement circuitry inside an instrument. The voltage guard provides a low-impedance path to ground for common-mode noise and ground currents, thereby eliminating errors introduced by such interference.

**watt**

The unit of power in the SI system of units. One watt is the power required to do work at the rate of one joule/second. In terms of volts and ohms, one watt is the power dissipated by one ampere flowing through a one-ohm load.

**working standard**

A standard that is used in routine calibration and comparison procedures in the laboratory, and is maintained by comparison to reference standards.

**zero error**

Same as offset error. The reading shown on a meter when an input value of zero is applied is its zero or offset error.





***Appendix B***  
***ASCII and IEEE-488 Bus Codes***



ASCII CHAR.	DECIMAL	OCTAL	HEX	BINARY 7654 3210	DEV. NO.	MESSAGE ATN=TRUE	ASCII CHAR.	DECIMAL	OCTAL	HEX	BINARY 7654 3210	DEV. NO.	MESSAGE ATN=TRUE
NUL	0	000	00	0000 0000			@	64	100	40	0100 0000	0	MTA
SQH	1	001	01	0000 0001			A	65	101	41	0100 0001	1	MTA
STX	2	002	02	0000 0010		GTL	B	66	102	42	0100 0010	2	MTA
ETX	3	003	03	0000 0011			C	67	103	43	0100 0011	3	MTA
EOT	4	004	04	0000 0100			D	68	104	44	0100 0100	4	MTA
ENQ	5	005	05	0000 0101		SDC PPC	E	69	105	45	0100 0101	5	MTA
ACH	6	006	06	0000 0110			F	70	106	46	0100 0110	6	MTA
BELL	7	007	07	0000 0111			G	71	107	47	0100 0111	7	MTA
BS	8	010	08	0000 1000			H	72	110	48	0100 1000	8	MTA
HT	9	011	09	0000 1001		GET TCT	I	73	111	49	0100 1001	9	MTA
LF	10	012	0A	0000 1010			J	74	112	4A	0100 1010	10	MTA
VT	11	013	0B	0000 1011			K	75	113	4B	0100 1011	11	MTA
FF	12	014	0C	0000 1100			L	76	114	4C	0100 1100	12	MTA
CR	13	015	0D	0000 1101			M	77	115	4D	0100 1101	13	MTA
SO	14	016	0E	0000 1110			N	78	116	4E	0100 1110	14	MTA
SI	15	017	0F	0000 1111			O	79	117	4F	0100 1111	15	MTA
DLE	16	020	10	0001 0000			P	80	120	50	0101 0000	16	MTA
DC1	17	021	11	0001 0001		LLO	Q	81	121	51	0101 0001	17	MTA
DC2	18	022	12	0001 0010			R	82	122	52	0101 0010	18	MTA
DC3	19	023	13	0001 0011			S	83	123	53	0101 0011	19	MTA
DC4	20	024	14	0001 0100		DCL PPU	T	84	124	54	0101 0100	20	MTA
NAK	21	025	15	0001 0101			U	85	125	55	0101 0101	21	MTA
SYN	22	026	16	0001 0110			V	86	126	56	0101 0110	22	MTA
ETB	23	027	17	0001 0111			W	87	127	57	0101 0111	23	MTA
CAN	24	030	18	0001 1000		SPE SPD	X	88	130	58	0101 1000	24	MTA
EM	25	031	19	0001 1001			Y	89	131	59	0101 1001	25	MTA
SUB	26	032	1A	0001 1010			Z	90	132	5A	0101 1010	26	MTA
ESC	27	033	1B	0001 1011			[	91	133	5B	0101 1011	27	MTA
FS	28	034	1C	0001 1100			\	92	134	5C	0101 1100	28	MTA
GS	29	035	1D	0001 1101			]	93	135	5D	0101 1101	29	MTA
RS	30	036	1E	0001 1110			^	94	136	5E	0101 1110	30	MTA
US	31	037	1F	0001 1111			_	95	137	5F	0101 1111	30	MTA UNT
SPACE	32	040	20	0010 0000	0	MLA	,	96	140	60	0111 0000	0	MSA
!	33	041	21	0010 0001	1	MLA	a	97	141	61	0111 0001	1	MSA
"	34	042	22	0010 0010	2	MLA	b	98	142	62	0111 0010	2	MSA
#	35	043	23	0010 0011	3	MLA	c	99	143	63	0111 0011	3	MSA
\$	36	044	24	0010 0100	4	MLA	d	100	144	64	0111 0100	4	MSA
%	37	045	25	0010 0101	5	MLA	e	101	145	65	0111 0101	5	MSA
&	38	046	26	0010 0110	6	MLA	f	102	146	66	0111 0110	6	MSA
'	39	047	27	0010 0111	7	MLA	g	103	147	67	0111 0111	7	MSA
(	40	050	28	0010 1000	8	MLA	h	104	150	68	0111 1000	8	MSA
)	41	051	29	0010 1001	9	MLA	i	105	151	69	0111 1001	9	MSA
*	42	052	2A	0010 1010	10	MLA	j	106	152	6A	0111 1010	10	MSA
+	43	053	2B	0010 1011	11	MLA	k	107	153	6B	0111 1011	11	MSA
,	44	054	2C	0010 1100	12	MLA	l	108	154	6C	0111 1100	12	MSA
-	45	055	2D	0010 1101	13	MLA	m	109	155	6D	0111 1101	13	MSA
.	46	056	2E	0010 1110	14	MLA	n	110	156	6E	0111 1110	14	MSA
/	47	057	2F	0010 1111	15	MLA	o	111	157	6F	0111 1111	15	MSA
0	48	060	30	0011 0000	16	MLA	p	112	160	70	0111 0000	16	MSA
1	49	061	31	0011 0001	17	MLA	q	113	161	71	0111 0001	17	MSA
2	50	062	32	0011 0010	18	MLA	r	114	162	72	0111 0010	18	MSA
3	51	063	33	0011 0011	19	MLA	s	115	163	73	0111 0011	19	MSA
4	52	064	34	0011 0100	20	MLA	t	116	164	74	0111 0100	20	MSA
5	53	065	35	0011 0101	21	MLA	u	117	165	75	0111 0101	21	MSA
6	54	066	36	0011 0110	22	MLA	v	118	166	76	0111 0110	22	MSA
7	55	067	37	0011 0111	23	MLA	w	119	167	77	0111 0111	23	MSA
8	56	070	38	0011 1000	24	MLA	x	120	170	78	0111 1000	24	MSA
9	57	071	39	0011 1001	25	MLA	y	121	171	79	0111 1001	25	MSA
:	58	072	3A	0011 1010	26	MLA	z	122	172	7A	0111 1010	26	MSA
;	59	073	3B	0011 1011	27	MLA	{	123	173	7B	0111 1011	27	MSA
<	60	074	3C	0011 1100	28	MLA		124	174	7C	0111 1100	28	MSA
=	61	075	3D	0011 1101	29	MLA	}	125	175	7D	0111 1101	29	MSA
>	62	076	3E	0011 1110	30	MLA	~	126	176	7E	0111 1110	30	MSA
?	63	077	3F	0011 1111	30	UNL		127	177	7F	0111 1111	30	UNS



# Appendix C

## RS-232/IEEE-488 Cables and Connectors

### IEEE-488 Connector

The IEEE-488 connector on the rear panel mates with an IEEE-488 standard cable. The pin assignments of the rear-panel IEEE-488 connector are shown in Figure C-1. IEEE-488 connection cables are available from Fluke as shown in Table C-1. See Chapter 9, “Accessories,” for ordering information.

**Table C-1. IEEE-488 Connection Cables**

IEEE-488 Connection Cable	Fluke Part Number
0.5 m (1.64 feet)	PM2295/05
1 m (3.28 feet)	PM2295/10
2 m (6.56 feet)	PM2295/20

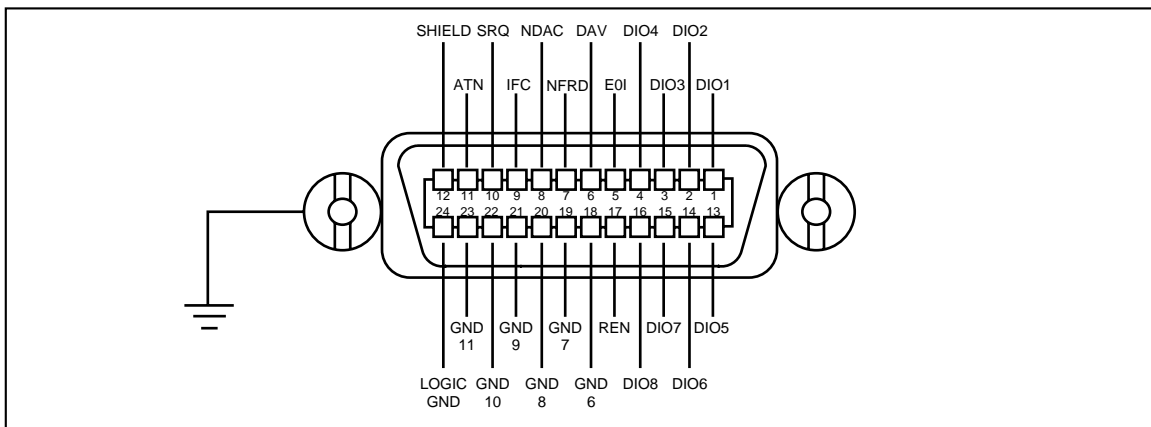

**Figure C-1. IEEE-488 Connector Pinout (connection side)**

Fe-01.eps

## Serial Connectors

The two 9-pin serial connectors on the rear panel of the 5500A Calibrator are used to interface with a computer, or controller, and an instrument serial port. The pin assignments of the rear-panel serial connectors are in conformance to EIA/TIA-574 standard and are shown in Figures C-1 (Host) and C-2 (UUT).

Serial connection cables are available from Fluke are shown in Table C-2. See Chapter 9, "Accessories," for ordering information.

**Table C-2. Serial Port Connection Cables**

Connection Cable		Fluke Part Number
5500A SERIAL 1 FROM HOST	PC COM port (DB-9)	PM8914/001
5500A SERIAL 1 FROM HOST	PC COM port (DB-25)	RS40
5500A SERIAL 2 TO UUT	UUT serial port (DB-9)	943738
5500A SERIAL 2 TO UUT	UUT serial port (DB-25)	n/a

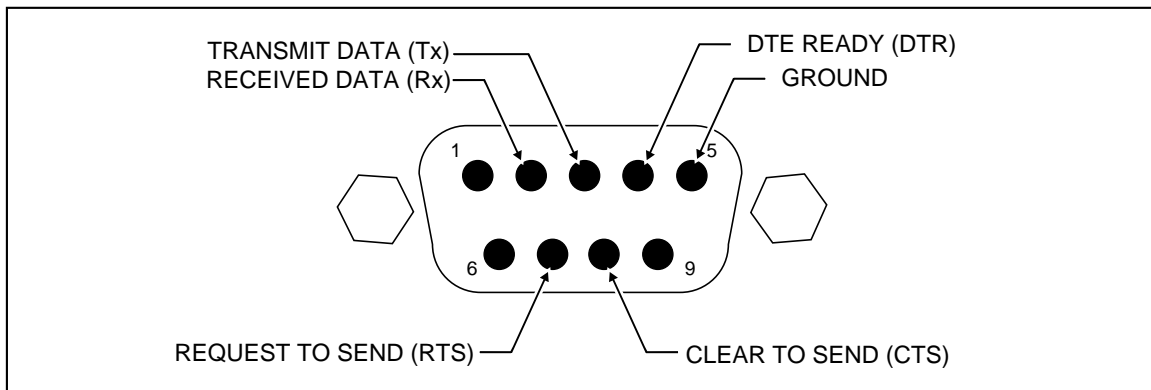

Fe-02.eps

**Figure C-2. SERIAL 1 FROM HOST Port Connector Pinout**

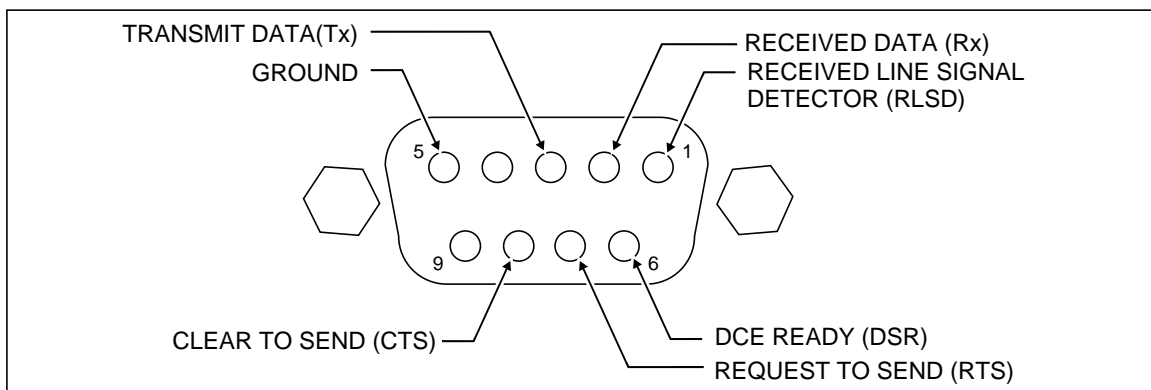

Fe-03.eps

**Figure C-3. SERIAL 2 TO UUT Port Connector Pinout (connection side)**

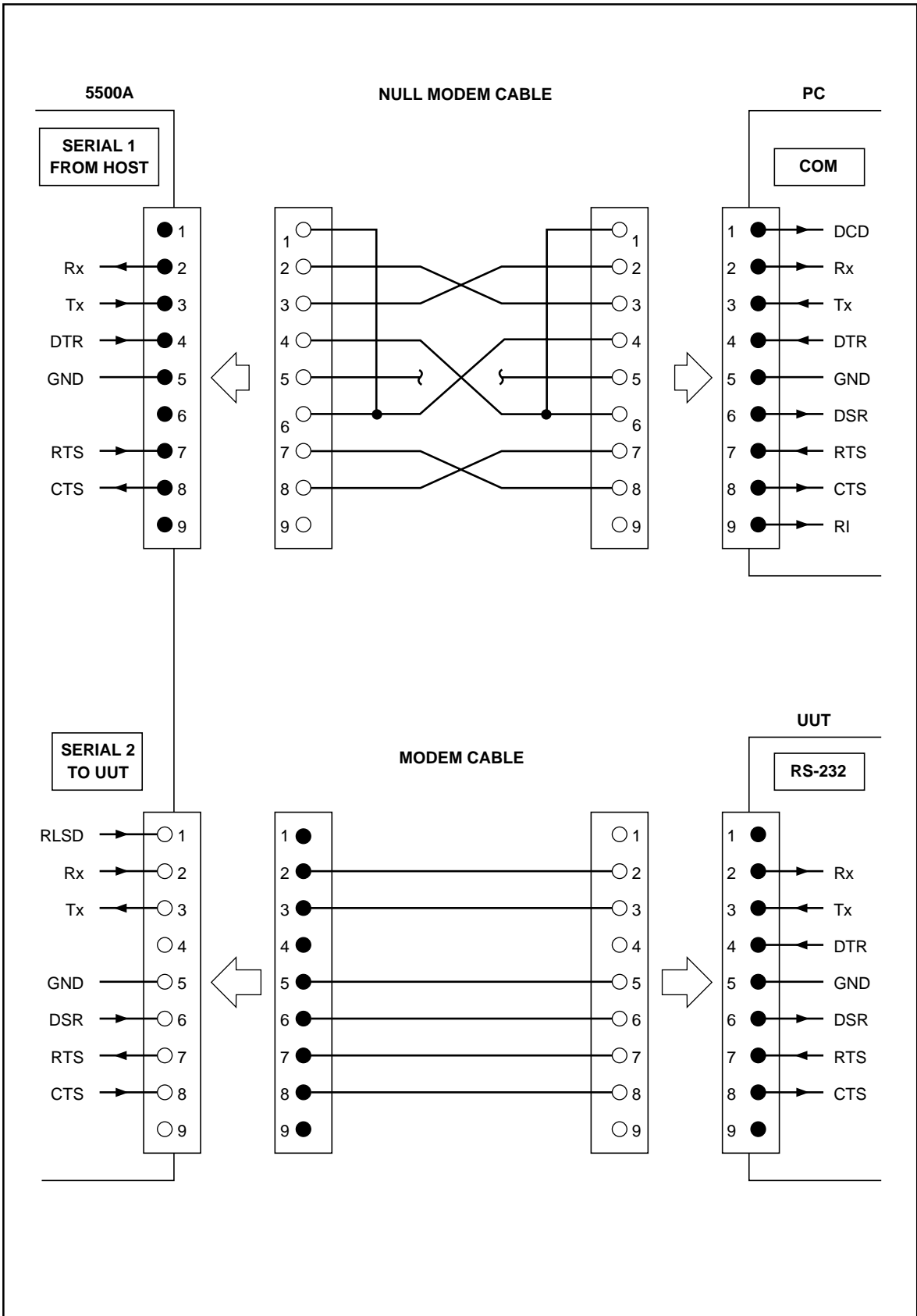

Figure C-4. Serial Port Connections (DB-9/DB-9)

Fe-04.eps

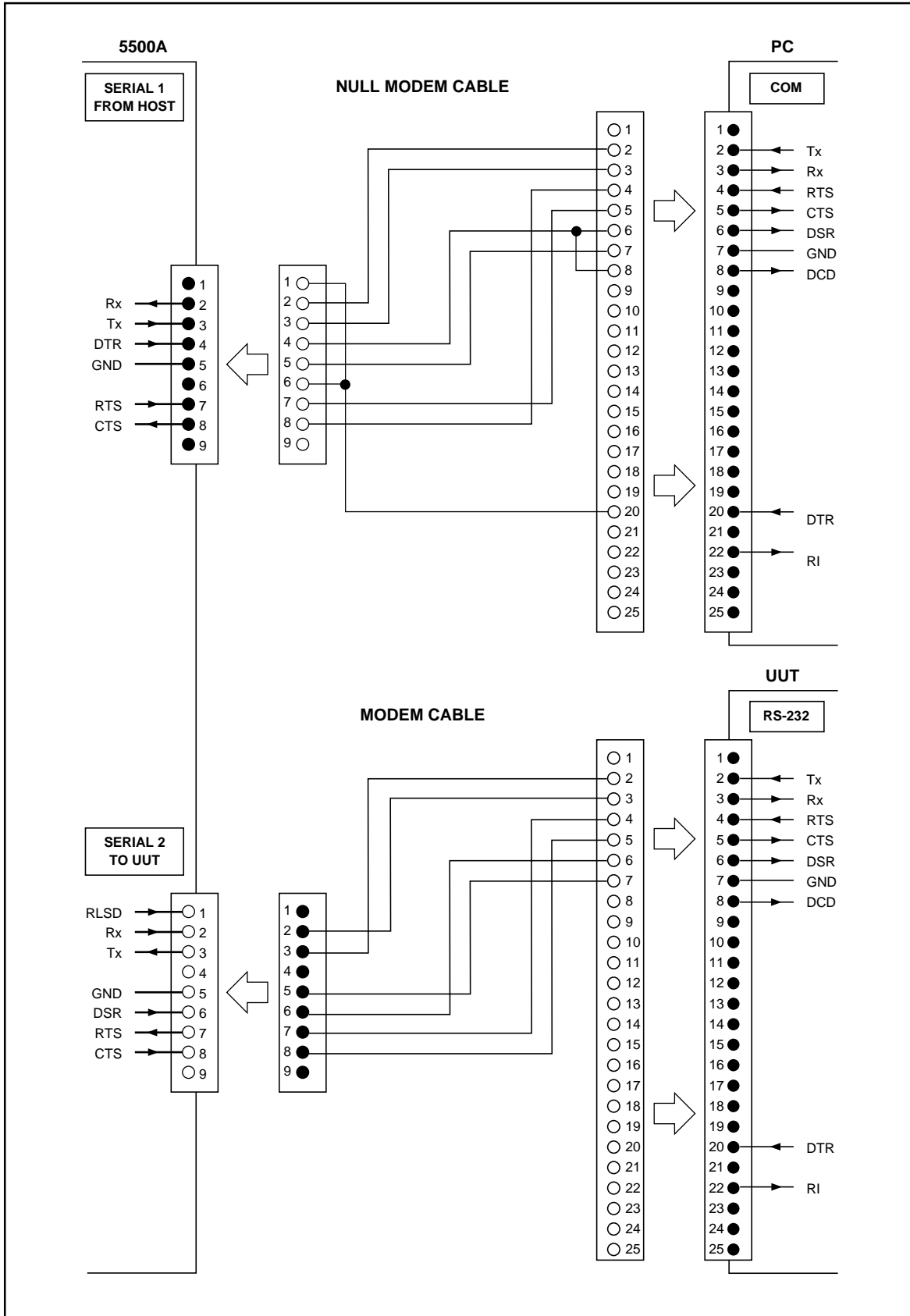

Figure C-5. Serial Port Connections (DB-9/DB-25)

Fe-05.eps



## Appendix D

# Creating a Visual Basic Test Program

### Creating a Visual Basic Test Program

The following procedure creates a test program in Visual Basic that you may use to test 5500A Calibrator RS-232 Host port and RS-232 UUT port operation. This program is referenced in Chapter 4 under “Testing RS-232 (Host) Operation using Visual Basic” and “Testing RS-232 (UUT) Operation using Visual Basic.” This procedure assumes you have access to the Custom Control Icons in your edition of Visual Basic, and creates the least complicated program for RS-232 testing.

Complete the following procedure to create an RS-232 test program in Visual Basic.

1. Open Microsoft Visual Basic from the Visual Basic group, displaying the Form1 screen (below).

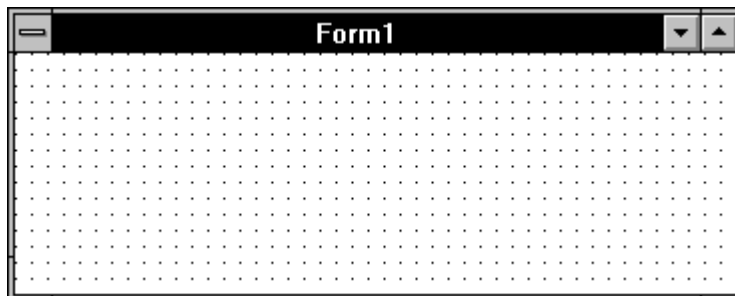

FF-06.bmp

2. From the Toolbox, double click the Command icon , creating a Command1 button on the Form1 screen. Repeat, creating a Command2 button. Repeat again creating a Command3 button.

- Separate the Command buttons and resize the form for ease of use (below is typical).

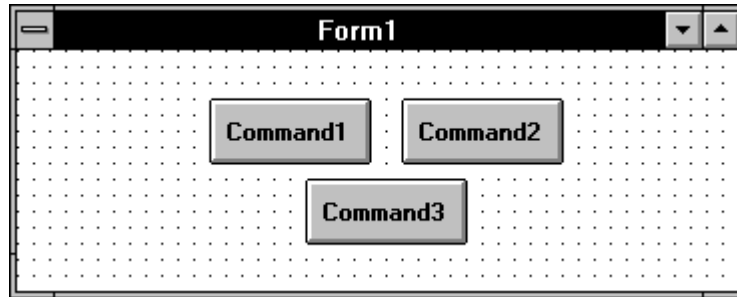

Ff-0a.bmp

- From the Toolbox, double click the Communications icon , placing the icon on the Form1 screen. This custom control icon provides complete serial communications capabilities for this program. Position the icon anywhere on the Form1 screen that is convenient.
- Double click on a clear area of the Form1 screen to open the Code window for Form1. Enter the code shown below. If using COM2 on the PC, change the command to `Comm1.CommPort = 2`. If not using the factory default settings for the RS-232 ports, then change the command `Comm1.Settings` as required.

```
Sub Form_Load ()
    Comm1.CommPort = 1           [if using COM2, enter = 2]
    Comm1.Settings = "9600,N,8,1" [baud, parity, data, stop]
    Comm1.PortOpen = True
End Sub
```

- While still in the Code window, select Command1 from the Object list. Enter the code shown below. The `Chr(10)` means ascii character 10 (line feed).

```
Sub Command1_Click ()
    Comm1.Output = "REMOTE" + Chr(10)
End Sub
```

- Select Command2 from the Object list. Enter the code shown below.

```
Sub Command2_Click ()
    Comm1.Output = "LOCAL" + Chr(10)
End Sub
```

- Select Command3 from the Object list. Enter the code shown below, where `<uut command>` is the command you selected for the UUT response.

```
Sub Command3_Click ()
    Comm1.Output = "UUT_SEND ""<uut command>"" " + Chr(10)
End Sub
```

For example, "UUT\_SEND ""REMS\n"" ". Note the use of `\n`, which indicates a Carriage Return (CR) as the end-of-line character. Other characters include `\r` (Line Feed), `\t` (Tab), `\b` (Backspace) and `\f` (Form Feed). Also note the double quotes around `<uut command>` to show embedded quotes.

9. On the Visual Basic Toolbar, click the Start button  to run the RS-232 test program (below is typical). If there are no errors, continue to Step 10.

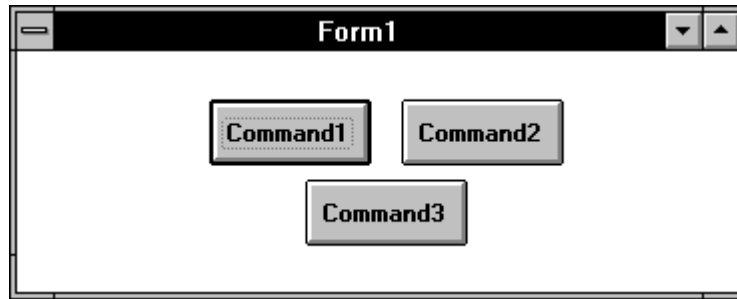

FF-0d.bmp

10. Click the Stop button  on the Toolbar to stop the program.  
 (Hint: Before continuing to the next step, connect the 5500A Calibrator and UUT (if applicable) and test the program in actual operation.)
11. Save the program as `vb_rs232.exe` by selecting the Make EXE File command from the File menu. Save the program files by selecting the Save Program command from the File menu.
12. Select the Exit command from the File menu to exit Visual Basic.
13. In Program Manager, select New from the File menu. Check Program Group, then click OK. In the Description box, enter RS-232 Test then click OK. This creates and opens the RS-232 Test group.
14. With the RS-232 Test group still open, select New from the File menu. Check Program Item, then click OK. In the Description box, enter Test Ports. Use Browse to locate your `vb_rs232.exe` file, then click OK to enter this file in the Command Line box. Click OK. This creates the Test Ports icon (below).

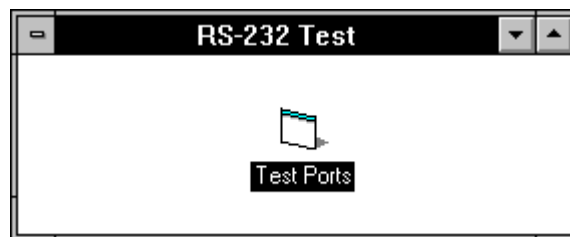

FF-0c.bmp



# Appendix E Error Message

## Error Messages

The following is a list of the 5500A Calibrator error messages. The error message format is shown in Table E-1.

**Table E-1. Error Message Format**

Error Number	(Message Class : Description)	Text characters
0 to 65535	<b>QYE</b> Query Error, caused by a full input buffer, unterminated action or interrupted action	<b>F</b> Error is displayed on the front panel as it occurs Up to 36 text characters
	<b>DDE</b> Device-Specific Error, caused by the 5500A due to some condition, for example, overrange	<b>R</b> Error is queued to the remote interface as it occurs
	<b>EXE</b> Execution Error, caused by an element outside of, or inconsistent with, the 5500A capabilities	<b>S</b> Error causes instrument to go to Standby
	<b>CME</b> Command Error, caused by incorrect command syntax, unrecognized header, or parameter of the wrong type	<b>D</b> Error causes instrument returns to the power up state
		(none) Error is returned to the initiator only (i.e., local initiator or remote initiator)

```

0      (QYE:      )  No Error
1      (DDE:FR   )  Error queue overflow
100    (DDE:FR D)  Inguard not responding (send)
101    (DDE:FR D)  Inguard not responding (recv)
102    (DDE:FR D)  Lost sync with inguard
103    (DDE:FR   )  Invalid guard xing command
  
```

104 (DDE:FR D) Hardware relay trip occurred  
105 (DDE:FR D) Inguard got impatient  
106 (DDE:FR D) A/D fell asleep  
107 (DDE:FR D) Inguard watchdog timeout  
201 (DDE:FR D) 5725A ROM failure  
202 (DDE:FR D) 5725A RAM failure  
203 (DDE:FR D) 5725A EEPROM failure  
204 (DDE:FR D) 5725A data bus failure  
205 (DDE:FR D) 5725A CLAMPS circuit failure  
206 (DDE:FR D) 5725A HVCLR circuit failure  
207 (DDE:FR D) 5725A DAC failure  
208 (DDE:FR D) 5725A watchdog timer fault  
209 (DDE:FR D) 5725A I heatsink too hot  
210 (DDE:FRS ) Output tripped to standby  
211 (DDE:FR D) 5725A compliance V exceeded  
212 (DDE:FRS ) 5725A compliance V exceeded  
213 (DDE:FR D) 5725A +400V did not shut off  
214 (DDE:FR D) 5725A -400V did not shut off  
215 (DDE:FR D) 5725A V heatsink too hot  
216 (DDE:FRS ) 5725A V heatsink too hot  
217 (DDE:FR D) 5725A +400V supply too small  
218 (DDE:FR D) 5725A +400V supply too large  
219 (DDE:FR D) 5725A -400V supply too large  
220 (DDE:FR D) 5725A -400V supply too small  
221 (DDE:FR D) 5725A +400V supply overI  
222 (DDE:FRS ) Output tripped to standby  
223 (DDE:FR D) 5725A -400V supply overI  
224 (DDE:FRS ) Output tripped to standby  
225 (DDE:FR D) 5725A fan not working  
226 (DDE:FR D) 5725A CLAMPS fault  
227 (DDE:FRS ) Output tripped to standby  
228 (DDE:FR D) 5725A software TRAP  
229 (DDE:FR D) 5725A cable was off  
230 (DDE:FR D) 5725A RESET  
231 (DDE:FR D) 5725A guard-crossing timeout  
232 (DDE:FR D) 5725A illegal command  
233 (DDE:FR D) 5725A non-maskable interrupt  
234 (DDE:FR D) 5725A HVCLEAR tripped  
235 (DDE:FRS ) Output tripped to standby  
300 (DDE: ) Invalid procedure number  
301 (DDE: ) No such step in procedure  
302 (DDE: ) Can't change that while busy  
303 (DDE: ) Can't begin/resume cal there  
304 (DDE: ) Wrong unit for reference  
305 (DDE: ) Entered value out of bounds  
306 (DDE: ) Not waiting for a reference  
307 (DDE: ) Continue command ignored  
308 (DDE:FR ) Cal constant outside limits  
309 (DDE:FR ) Cal try to null failed  
310 (DDE:FR D) Sequence failed during cal  
311 (DDE:FR D) A/D measurement failed  
312 (DDE:FR ) Invalid cal step parameter  
313 (DDE: ) Cal switch must be ENABLED  
314 (DDE:FR ) Divide by zero encountered  
315 (DDE:FR ) Must be in OPER at this step

```

316 (DDE:FR ) Open thermocouple for RJ cal
400 (DDE:FR D) Encoder not responding VERS
401 (DDE:FR D) Encoder not responding COMM
402 (DDE:FR D) Encoder not responding STAT
403 (DDE:FR ) Encoder self-test failed
404 (DDE:FR D) Queue from 5725A full
405 (DDE:FR ) Message over display R side
406 (DDE:FR ) Unmappable character #%d [%d is an ASCII character]
407 (DDE:FR ) Encoder did not reset
408 (DDE:FR ) Encoder got invalid command
500 (DDE: ) Internal state error
501 (DDE: ) Invalid keyword or choice
502 (DDE: ) Harmonic must be 1 - 50
503 (DDE: ) Frequency must be >= 0
504 (DDE: ) AC magnitude must be > 0
505 (DDE: ) impedance must be >= 0
506 (DDE: ) Function not available
507 (DDE: ) Value not available
508 (DDE: ) Cannot enter watts by itself
509 (DDE: ) Output exceeds user limits
510 (DDE: ) Duty cycle must be 1.0-99.0
511 (DDE: ) Power factor must be 0.0-1.0
512 (DDE: ) Can't select that field now
513 (DDE: ) Edit digit out of range
514 (DDE: ) Can't switch edit field now
515 (DDE: ) Not editing output now
516 (DDE: ) dBm works only for sine ACV
517 (DDE: ) Freq too high for non-sine
518 (DDE: ) Value outside locked range
519 (DDE: ) Must specify an output unit
520 (DDE: ) Can't do two freqs at once
521 (DDE: ) Can't source 3 values at once
522 (DDE: ) Temp must be degrees C or F
523 (DDE: ) Can't do that now
524 (DDE: ) Can't turn on the boost
525 (DDE: ) Can't turn off the boost
526 (DDE: ) Limit too small or large
527 (DDE: ) No changes except RESET now
528 (DDE:FR D) 5725A went away while in use
529 (DDE: ) Cannot edit to or from 0 Hz
530 (DDE: ) Bad state image - not loaded
531 (DDE: ) TC offset limited to +/-500 C
532 (DDE: ) Can't go to STBY in Meas TC
533 (DDE: ) Can't set an offset now
534 (DDE: ) Can't lock this range
535 (DDE: ) Can't set phase or PF now
536 (DDE: ) Can't set wave now
537 (DDE: ) Can't set harmonic now
538 (DDE: ) Can't change duty cycle now
539 (DDE: ) Can't change compensation now
540 (DDE:FR ) Current OUTPUT moved to 5725A
541 (DDE: ) TC ref must be valid TC temp
542 (DDE: ) Can't turn EARTH on now
543 (DDE: D) STA couldn't update OTD
544 (DDE: ) Can't enter W with non-sine

```

545 (DDE: ) ) Can't edit now  
546 (DDE: ) ) Can't set trigger to that now  
547 (DDE: ) ) Can't set output imp. now  
548 (DDE:FR ) ) Compensation is now OFF  
549 (DDE: ) ) Period must be >= 0  
550 (DDE: ) ) A report is already printing  
551 (DDE: ) ) -SC option not installed  
600 (DDE:FR D) ) Outguard watchdog timeout  
601 (DDE: ) ) Power-up RAM test failed  
602 (DDE:FR ) ) Power-up GPIB test failed  
700 (DDE: R ) ) Saving to NV memory failed  
701 (DDE: R ) ) NV memory invalid  
702 (DDE: R ) ) NV invalid so default loaded  
703 (DDE: R ) ) NV obsolete so default loaded  
800 (DDE:FR ) ) Serial parity error %s [%s is serial port]  
801 (DDE:FR ) ) Serial framing error %s [%s is serial port]  
802 (DDE:FR ) ) Serial overrun error %s [%s is serial port]  
803 (DDE:FR ) ) Serial characters dropped %s [%s is serial port]  
900 (DDE:FR ) ) Report timeout - aborted  
1000 (DDE:FR ) ) Sequence failed during diag  
1001 (DDE:FR ) ) Guard xing link diag fail  
1002 (DDE:FR ) ) Inguard bus r/w diag fail  
1003 (DDE:FR ) ) A6 A/D comm fault  
1004 (DDE:FR ) ) A6 A/D or DAC fault  
1005 (DDE:FR ) ) A6 DAC fine channel fault  
  
1006 through 1090 Error messages for self diagnostics. Refer  
to Chapter 4 of the *5500A Service Manual* for  
the message and a description of the possible  
cause.  
  
1200 (DDE:FR ) ) Sequence name too long  
1201 (DDE:FR ) ) Sequence RAM table full  
1202 (DDE:FR ) ) Sequence name table full  
1300 (CME: R ) ) Bad syntax  
1301 (CME: R ) ) Unknown command  
1302 (CME: R ) ) Bad parameter count  
1303 (CME: R ) ) Bad keyword  
1304 (CME: R ) ) Bad parameter type  
1305 (CME: R ) ) Bad parameter unit  
1306 (EXE: R ) ) Bad parameter value  
1307 (QYE: R ) ) 488.2 I/O deadlock  
1308 (QYE: R ) ) 488.2 interrupted query  
1309 (QYE: R ) ) 488.2 unterminated command  
1310 (QYE: R ) ) 488.2 query after indefinite response  
1311 (DDE: R ) ) Invalid from GPIB interface  
1312 (DDE: R ) ) Invalid from serial interface  
1313 (DDE: R ) ) Service only  
1314 (EXE: R ) ) Parameter too long  
1315 (CME: R ) ) Invalid device trigger  
1316 (EXE: R ) ) Device trigger recursion  
1317 (CME: R ) ) Serial buffer full  
1318 (EXE: R ) ) Bad number  
1319 (EXE: R ) ) Service command failed



```

1320 (CME: R ) Bad binary number
1321 (CME: R ) Bad binary block
1322 (CME: R ) Bad character
1323 (CME: R ) Bad decimal number
1324 (CME: R ) Exponent magnitude too large
1325 (CME: R ) Bad hexadecimal block
1326 (CME: R ) Bad hexadecimal number
1328 (CME: R ) Bad octal number
1329 (CME: R ) Too many characters
1330 (CME: R ) Bad string
1331 (DDE: R ) OPER not allowed while error pending
1500 (DDE:FRS ) Compliance voltage exceeded
1501 (DDE:FRS ) Shunt amp over or underload
1502 (DDE:FRS ) Heat sink too hot
1503 (DDE:FRS ) Output current lim exceeded
1504 (DDE:FRS ) Input V or A limit exceeded
1600 (DDE:FR D) OPM transition error
1601 (DDE:FR D) TC measurement failure
1800 (DDE:FR ) Unknown boost command
1801 (DDE:FR ) BX not responding
65535 (DDE:FR ) Unknown error %d [%d is unknown error number]
  
```



# Index

## —\*—

- \*CLS remote command, 6-12
- \*ESE remote command, 6-16
- \*ESE? remote command, 6-16
- \*ESR? remote command, 6-16
- \*IDN? remote command, 6-20
- \*OPC, 5-45
- \*OPC remote command, 6-26
- \*OPC?, 5-45
- \*OPC? remote command, 6-26
- \*OPT? remote command, 6-26
- \*PUD remote command, 6-30
- \*PUD? remote command, 6-31
- \*RST remote command, 6-33
- \*SRE remote command, 6-37
- \*SRE? remote command, 6-37
- \*STB? remote command, 6-38
- \*TEMP\_STD? remote command, 6-42
- \*TRG remote command, 6-43
- \*TST? remote command, 6-44
- \*WAI, 5-45
- \*WAI remote command, 6-47

## —5—

- 5500A Operator Manual, 1-6
- 5500A Operator Reference Guide, 1-7
- 5500A Remote Programming Reference Guide, 1-7
- 5500A Service Manual, 1-7
- 5500A/LEADS**, 9-4
- 5725A Amplifier, 1-7
  - Accessory, 9-4
  - Connecting the, 2-7
  - Output of, 4-48
  - Selecting the, 4-5
  - Using the, 4-47
- 5725A Amplifier Accessory**, 9-4
- 5725A Amplifier Output, 4-48

## —A—

- AC Current Amplitude Accuracy, 7-15
- AC Current Output, 4-22
- AC Power Amplitude Accuracy (High Current), 7-20
- AC Power Amplitude Accuracy (High Power), 7-21
- AC Power Amplitude Accuracy (High Voltage), 7-20
- AC POWER INPUT Module, 3-11
- AC POWER INPUT Module, location of, 3-11
- AC Power Output, 4-25
- AC Voltage
  - Dual Output Setting, 4-30
- AC Voltage Accuracy with a DC Offset, 7-27
- AC Voltage Amplitude Accuracy (AUX), 7-13
- AC Voltage Amplitude Accuracy (NORMAL), 7-12
- AC Voltage Amplitude Accuracy, Squarewaves (AUX), 7-24
- AC Voltage Amplitude Accuracy, Squarewaves (NORMAL), 7-23
- AC Voltage Harmonic Amplitude Accuracy (AUX), 7-26
- AC Voltage Harmonic Amplitude Accuracy (NORMAL), 7-25
- AC Voltage Output, Setting of, 4-19
- AC voltage, dc offset specifications, 1-29
- Accessing the Fuse and Selecting Line Voltage, 2-5
- Adjusting the Phase, 4-43
- Air Filter, Cleaning the, 7-4
- Amplitude Calibration, 8-16, 8-18, 8-69, 8-71
- Applications, 4-52
  - Calibrating a Fluke 51 Thermometer, 4-61
  - Calibrating an 80 Series DMM, 4-52
  - Testing a Model 41 Power Harmonics Analyzer, 4-58
- Auto Range, 4-17
- Auto Range versus Locked Range, 4-17

## —B—

- BOOST key, 3-5
- BOOST remote command, 6-8
- BOOST? remote command, 6-8

Bus Setup Procedure, 5-7

## —C—

Cable Connection Instructions, 4-11  
Cable Connections for Testing a 40 Series Watts Function, 4-59  
Cable Connections for Testing a 50 Series Thermometer, 4-62  
Cable Connections for Testing an 80 Series Current Function, 4-55  
Cable Connections for Testing an 80 Series General Functions, 4-53  
Cable Connections for Testing an 80 Series High Amps Function, 4-57  
Cable recommendations, 4-9  
Cables, 4-52  
Calculating power uncertainty, 1-25  
Calibrating an  
    80 Series DMM, 4-52  
    Fluke 51 Thermometer, 4-61  
Calibrating the Meter, 4-57  
Calibrating the Thermocouple, 4-63  
Calibration Check, Performing a, 7-6  
CALIBRATION Switch, 3-10  
Calibration Switch, Enabled Commands, 5-29  
Capacitance Accuracy, 7-17  
Capacitance Output Setting, 4-33  
Caution, 4-63, 7-6  
CAUTION, 2-3, 2-7, 4-6, 4-9, 4-18, 4-19, 4-24, 4-26, 4-28, 4-30, 7-4  
CE key, 3-6  
CFREQ? remote command, 6-12  
Changing between remote and local operation, 5-21  
Character Processing, Incoming, 5-33  
CHASSIS GROUND Binding Post, 3-11  
Checking 5500A status, 5-35  
Cleaning the Air Filter, 7-4  
Cleaning, General, 7-6  
CLS remote command, 6-12  
Command Summary by Function, 6-3  
Command syntax information, 5-31  
Commands  
    Alphabetical List, 6-8  
    Calibration Switch Enabled, 5-29  
    Common, 5-26  
    Compound, 5-28  
    Coupled, 5-28  
    Device-Dependent, 5-25  
    IEEE-488 Only, 5-30  
    Overlapped, 5-29  
    Query, 5-26  
    RS-232 Only, 5-29  
    Sequential, 5-29  
    Summary by Function, Table of, 6-3

Types of, 5-25

Using, 5-25

Commands for RS-232 Only, 5-29  
Common Commands, 5-26, 6-4  
Compound Commands, 5-28  
Connecting the 5725A Amplifier, 2-7  
Connecting the Calibrator to a UUT, 4-9  
Control Display, 3-4  
Cooling Considerations, 2-7  
Coupled Commands, 5-28  
CUR\_POST remote command, 6-12  
CUR\_POST? remote command, 6-12  
Current  
    Limit setting, 4-51  
    Setting AC Output, 4-22  
    Setting DC output, 4-21

## —D—

DC Current Amplitude Accuracy, 7-9  
DC Current Output, 4-21  
DC Offset, Entering of, 4-46  
DC Power Amplitude Accuracy (AUX), 7-19  
DC Power Amplitude Accuracy (NORMAL), 7-19  
DC Power Output, 4-24  
DC Voltage Amplitude Accuracy (AUX), 7-8  
DC Voltage Amplitude Accuracy (NORMAL), 7-7  
DC Voltage Offset Accuracy, 7-26  
DC Voltage Output, Setting of, 4-18  
DC Voltage, Dual voltage setting, 4-28  
DC\_OFFSET remote command, 6-13  
DC\_OFFSET? remote command, 6-13  
Device-Dependent Commands, 5-25  
Display  
    Control, 3-4  
    Output, 3-4  
Displaying the Output Error, 4-50  
DIVIDE key, 3-7  
Divide, Using Multiply and Divide, 4-50  
DPF remote command, 6-13  
DPF? remote command, 6-13  
Dual AC Voltage Output, 4-30  
Dual DC Voltage Output, 4-28  
DUTY remote command, 6-14  
DUTY? remote command, 6-14

## —E—

EARTH  
    When to Use, 4-10  
EARTH Connection, 4-52  
EARTH key, 3-5  
EARTH remote command, 6-14  
EARTH? remote command, 6-14  
Edge Function, 8-19, 8-72  
    Specifications, 8-7, 8-61

- Edit keys, 3-6
  - EDIT remote command, 6-15
  - EDIT? remote command, 6-15
  - Editing and Error Output Settings, 4-49
  - Editing Output Settings, 4-49
  - Editing the Output Setting, 4-49
  - EEPROM Format Menu, 4-6
  - ENTER key, 3-8
  - Entering a DC Offset, 4-46
  - Entering a Phase Angle, 4-44
  - Entering a Power Factor, 4-45
  - ERR? remote command, 6-15
  - ERR\_UNIT remote command, 6-16
  - Error Mode
    - Operation, 4-17
  - Error Mode Commands**, 6-3
  - Error Mode, Keys that exit, 4-49
  - Error Output, Displaying the, 4-50
  - Error Queue, 5-43
  - Error Settings, 4-49
  - ESE
    - Bit assignments, 5-38
    - Programming the, 5-39
  - ESE remote command, 6-16
  - ESE? remote command, 6-16
  - ESR
    - Explained, 5-38
    - Bit assignments, 5-38
    - Programming the, 5-39
    - Register, 5-38
  - ESR? remote command, 6-16
  - Event Status
    - Enable Register (ESE), 5-38
    - Register (ESR), 5-38
    - Register Bit assignments, 5-38
  - EXPLAIN? remote command, 6-17
  - External Connection Commands**, 6-3
  - Extra Space or Tab Characters, 5-32
- F—**
- Factory Defaults for SETUP, 4-7
  - Fan Filter, 3-10
  - FAULT? remote command, 6-17
  - Features
    - Front Panel, 3-4
    - Rear Panel, 3-10
  - Features (Chapter 3), 3-3
  - FORMAT remote command, 6-17
  - Four-Wire versus Two-Wire Connections, 4-10
  - Frequency Response Calibration, 8-24, 8-78
  - Frequency Response Calibration, 8-21
  - Frequency Response Calibration, 8-74
  - Frequency specifications, 1-26
  - Frequency Sweep for Oscilloscope Calibration, 8-24, 8-77
  - Front Panel Features, 3-3
  - Front Panel Operation (Chapter 4), 4-3
  - FUNC? remote command, 6-18
  - Function Generator, 8-28, 8-82
  - Fuse, Accessing the, 2-5
  - Fuse, Non-Operator Replacement, 7-27
  - Fuse, Replacement, 2-3
  - Fuse, Replacing the, 7-3
- G—**
- General Cleaning, 7-6
  - Guidelines for Programming the Calibrator, 5-43
- H—**
- HARMONIC remote command, 6-19
  - HARMONIC? remote command, 6-19
  - Harmonics
    - Setting, 4-42
    - Waveform, 4-42
  - Harmonics Performance for Amps, Harmonics screen, 4-61
  - Harmonics Performance for Volts, Harmonics Screen, 4-60
- I—**
- IDN remote command, 6-20
  - IEEE-488
    - Bus Setup Procedure, 5-7
    - interface, testing the, 5-8
    - Using for Remote Control, 5-4
  - IEEE-488 Interface Cable, 9-4
  - IEEE-488 Interface Messages, 5-26
  - IEEE-488 Interface Overview, 5-23
  - IEEE-488 Port, Testing the, 5-8
  - IEEE-488 Remote Control Connections, 5-5
  - Incoming Character Processing, 5-33
  - INCR remote command, 6-20
  - Input Buffer Operation, 5-47
  - Inspection, 2-3
  - Instruction Manuals, 1-6
  - Instrument Setup, 4-5
  - Instrument Status
    - Change Enable Register (ISCE), 5-40
    - Change Register (ISCR), 5-40
  - Instrument Status Register, 5-40
  - Interface Messages
    - Accepted by 5500A - Table of, 5-27
    - That the 5500A sends, 5-28
  - Interface Messages (IEEE-488), 5-26
  - Introduction and Specifications (Chapter 1), 1-3
  - ISCE

- Bit Assignments, 5-40
- Explained, 5-40
- Programming the, 5-42
- ISCE remote command, 6-20
- ISCE? remote command, 6-21
- ISCE0 remote command, 6-21
- ISCE0? remote command, 6-21
- ISCE1 remote command, 6-21
- ISCE1? remote command, 6-22
- ISCR
  - Bit Assignments, 5-40
  - Explained, 5-40
  - Programming the, 5-42
- ISCR? remote command, 6-22
- ISCR0? remote command, 6-22
- ISCR1? remote command, 6-22
- ISR
  - Bit Assignments, 5-40
  - Explained, 5-40
  - Programming the, 5-42
- ISR? remote command, 6-23

## —K—

Keys

- +/-, 3-9
- BOOST, 3-5
- CE, 3-6
- DIVIDE, 3-7
- EARTH, 3-5
- Edit, 3-6
- ENTER, 3-8
- MEASURE TC, 3-7
- Multiplier, 3-7
- MULTIPLY, 3-7
- NEW REF, 3-6
- NUMERIC, 3-8
- OPR, 3-5
- PREV MENU, 3-5
- RESET, 3-6
- SCOPE, 3-5
- SETUP, 3-6
- SHIFT, 3-8
- STBY, 3-5
- TRIG OUT, 3-7
- Units, 3-7

Keys That Exit Error Mode, 4-49

## —L—

- Leveled Sine Wave Function, 8-21, 8-74
  - Specifications, 8-8, 8-62
- Levsine Menu, 8-21, 8-74
  - Frequency Sweep, 8-24, 8-77
  - MORE OPTIONS menu, 8-23, 8-75
- LIMIT remote command, 6-23

- LIMIT? remote command, 6-23
- Line Power Cord Types, 2-6
- Line Power Cord Types - Table of, 2-6
- Line Power, Connecting to, 2-4
- Line Voltage, Selecting, 2-4
- Line Voltage, Selecting the, 2-5
- Local Operation, 1-4
- LOCAL remote command, 6-24
- Local State, 5-21
- Local with Lockout State, 5-21
- Locked Range, 4-17
- LOCKOUT remote command, 6-24
- Lockout State
  - Local with, 5-21
  - Remote with, 5-21
- LOWS remote command, 6-24
- LOWS? remote command, 6-24

## —M—

- Maintenance (Chapter 7), 7-3
- MEASURE TC key, 3-7
- Measuring Thermocouple Temperatures, 4-39
- Menu Tree
  - Softkeys, 3-12
- Modem Cables**, 9-4
- MORE OPTIONS menu, 8-23, 8-75
- MULT remote command, 6-25
- Multiplier Keys, 3-7
- MULTIPLY key, 3-7
- Multiply, Using Multiply and Divide, 4-50

## —N—

- NEW REF key, 3-6
- NEWREF remote command, 6-25
- Null-Modem Cables, 9-4
- NUMERIC keys, 3-8

## —O—

- OLDREF remote command, 6-25
- ONTIME? remote command, 6-25
- OPC remote command, 6-26
- OPC? remote command, 6-26
- OPER remote command, 6-26
- OPER? remote command, 6-26
- Operate and standby modes, 4-8
- Operating State Transitions
  - Local State, 5-21
  - Local with Lockout State, 5-21
  - Remote State, 5-21
- Operating State Transitions
  - Remote with Lockout State, 5-21
- Operation Overview, 1-4
- OPR key, 3-5

- OPT? remote command, 6-26
  - Options and Accessories, 9-3
  - Options and Accessories (Chapter 8), 9-3
  - Oscilloscope Calibration
    - Adjusting Output Signal, 8-14, 8-66
    - Amplitude, 8-16, 8-18, 8-69, 8-71
    - Commands and Queries, 8-34, 8-83
    - Edge Function, 8-19, 8-72
    - Frequency Response, 8-21, 8-24, 8-74, 8-78
    - Frequency Sweep, 8-24, 8-77
    - Horizontal Time Base, 8-26, 8-80
    - Introduction, 8-5, 8-59
    - Leveled Sine Wave Function, 8-21, 8-74
    - Marker Function, 8-26, 8-80
    - MORE OPTIONS menu, 8-23, 8-75
    - Oscilloscope Connection, 8-13, 8-65
    - Pulse Response, 8-19, 8-20, 8-21, 8-72, 8-73
    - Resetting Parameters, 8-15, 8-68
    - Starting, 8-13, 8-66
    - Testing the Trigger, 8-28, 8-82
    - Time Marker, 8-26, 8-80
    - Time Marker, 8-27, 8-81
    - Trigger Connection, 8-13, 8-65
    - V/DIV menu, 8-17, 8-70
    - Volt Function, 8-16, 8-69
    - Voltage Gain, 8-16, 8-18, 8-69, 8-71
    - Wave Generator, 8-28, 8-82
  - Oscilloscope Calibration Specifications, 8-5, 8-60
  - Oscilloscope Commands, 6-6
  - Oscilloscope Connection
    - Channel and External Trigger, 8-13, 8-65
  - Oscilloscope Connections, 8-13, 8-65
  - OUT remote command, 6-27
  - OUT? remote command, 6-28
  - OUT\_ERR? remote command, 6-29
  - Output Commands**, 6-5
  - Output Display, 3-4
  - Output Editing, 4-49
  - Output Limits, Setting of, 4-50
  - Output Queue, 5-42
  - Output Setting
    - AC Current, 4-22
    - AC Power, 4-25
    - AC Voltage, 4-19
    - Capacitance, 4-33
    - DC Current, 4-21
    - dc offset, 4-46
    - DC Power, 4-24
    - DC Voltage, 4-18
    - Dual AC Voltage, 4-30
    - Dual DC Voltage, 4-28
    - Phase Adjusting, 4-43
    - Power Factor, 4-45
    - Resistance, 4-32
    - Temperature Simulation, 4-35
    - Temperature Simulation (RTD), 4-37
  - Output Signal
    - Adjusting for Oscilloscope Calibration, 8-14, 8-66
  - Overlapped Commands, 5-29
- P—**
- Parameter Syntax Rules, 5-31
  - Peak-to-Peak Versus Rms Waveforms, 4-16
  - Performances Tests, 7-7
  - PF. See Power Factor
  - Phase Accuracy, 7-22
  - Phase Angle, Entering a, 4-44
  - PHASE remote command, 6-29
  - PHASE? remote command, 6-29
  - Placement of Calibrator, 2-7
  - Power
    - AC Output Setting, 4-25
    - DC Output Setting, 4-24
  - Power Cords, 2-6
  - Power Factor, Entering of, 4-45
  - POWER? remote command, 6-30
  - Preparing for Operation (Chapter 2), 2-3
  - PREV MENU key, 3-5
  - Program Examples
    - Remote, 5-43
    - Taking a Thermocouple Measurement, 5-46
    - Using \*OPC?, \*OPC, and \*WAI, 5-45
    - Verifying a Meter on IEEE-488 Bus, 5-45
    - Verifying a Meter on RS-232 Bus, 5-45
    - Writing an Error Handler, 5-44
    - Writing an SRQ handler, 5-44
  - Programming
    - The ESR and ESE, 5-39
    - the STB and SRE, 5-38
  - Programming the Calibrator, 5-43
  - PUD remote command, 6-30
  - PUD? remote command, 6-31
  - Pulse Response Calibration, 8-19, 8-20, 8-21, 8-72, 8-73
- Q—**
- Query Commands, 5-26
  - Queue
    - Output, 5-42
- R—**
- Rack Mount Kit, 9-4
  - Rack Mounting, 2-7
  - RANGE? remote command, 6-31
  - RANGELCK remote command, 6-31
  - RANGELCK? remote command, 6-32
  - Rear Panel Features, 3-3
  - Recommended Cable and Connector Types, 4-9

- REFOUT? remote command, 6-32
- Registers
  - Event Status (ESR), 5-38
  - Event Status Enable (ESE), 5-38
  - Instrument Status (ISR), 5-40
  - Instrument Status Change (ISCR), 5-40
  - Instrument Status Change Enable (ISCE), 5-40
- Remote Commands (Chapter 6), 6-3
- Remote Control
  - Using Host Port, 5-10, 5-15
  - Using IEEE Port, 5-4
- Remote Operation (Chapter 5), 5-4
- Remote Operation (IEEE-488), 1-5
- Remote Program Examples, 5-43
- REMOTE remote command, 6-32
- Remote State, 5-21
- Remote with Lockout State, 5-21
- Replacing the Line Fuse, 7-3
- RESET key, 3-6
- Resetting the Calibrator, 4-7
- Resistance Accuracy, 7-10
- Resistance DC Offset Measurement, 7-11
- Resistance Output Setting, 4-32
- Response Data Types
  - Binary Block Data, 5-34
  - Floating, 5-34
  - Indefinite ASCII, 5-34
  - Integer, 5-34
  - String, 5-34
  - Table of, 5-34
- Response Message Syntax, 5-34
- Rms Versus Peak-to-Peak Waveforms, 4-16
- RS-232
  - Controlling an Instrument, 5-46
  - Host Port Setup Procedure, 5-10
  - Using Host Port, 5-10, 5-15
  - UUT Port Setup Procedure, 5-15
- RS-232 Host Port Commands**, 6-6
- RS-232 Host Port Operation using a Terminal, 5-12
- RS-232 Host Port Operation using Visual Basic, 5-14
- RS-232 Host Port Setup Procedure, 5-10
- RS-232 Host Port, Testing the, 5-12
- RS-232 Interface Overview, 5-22
- RS-232 Modem Cables, 9-4
- RS-232 Null-Modem Cables, 9-4
- RS-232 Remote Control Connections, 5-6
- RS-232 UUT Port Commands**, 6-7
- RS-232 UUT Port Operation using Visual Basic, 5-18
- RS-232 UUT Port Operation via a Terminal, 5-17
- RS-232 UUT Port Setup Procedure, 5-15
- RS-232 UUT Port testing via IEEE-488 Port, 5-19
- RS-232 UUT Port testing via RS-232 Host Port, 5-17
- RST remote command, 6-33
- RTD, Setting Temperature Simulation, 4-37
- RTD\_TYPE remote command, 6-33

- RTD\_TYPE? remote command, 6-33
- RTD\_TYPE\_D remote command, 6-34
- RTD\_TYPE\_D? remote command, 6-34

## —S—

- Sample Applications, 4-52
- SCOPE key, 3-5
- Selecting an External Amplifier, 4-5
- Sequential Commands, 5-29
- Serial Poll
  - Status Byte, 5-35
- Service
  - Information, 2-6
- Service Request
  - SRQ Line, 5-37
- SERVICE REQUEST
  - Enable Register (SRE), 5-37
- Setting a Dual AC Voltage Output, 4-30
- Setting a Dual DC Voltage Output, 4-28
- Setting AC Current Output, 4-22
- Setting AC Power Output, 4-25
- Setting AC Voltage Output, 4-19
- Setting Capacitance Output, 4-33
- Setting DC Current Output, 4-21
- Setting DC Power Output, 4-24
- Setting DC Voltage Output, 4-18
- Setting Harmonics, 4-42
- Setting Output Limits, 4-50
- Setting Resistance Output, 4-32
- Setting Temperature Simulation (RTD), 4-37
- Setting Temperature Simulation (Thermocouple), 4-35
- Setting the Output, 4-17
- Setting up the RS-232 Host Port for Remote Control, 5-10
- Setting up the RS-232 UUT Port for Remote Control, 5-15
- Setting Voltage and Current Limits, 4-51
- Setup and Utility Commands**, 6-6
- SETUP key, 3-6
- Setup menu, 4-4
- Setup Menus
  - Format EEPROM menu, 4-6
  - IEEE-488 Port, 5-7
  - Instrument Setup, 4-5
  - RS-232 Host Port, 5-10
  - Utility Functions Menu, 4-6
- SETUP Softkey Menu Tree, 3-12
- SHIFT key, 3-8
- Shortcuts for Setting the Voltage Amplitude, 8-17
- Signal
  - Adjusting during Oscilloscope Calibration, 8-14, 8-66
- Sinewave, 4-41
- Softkey Menu Trees, 3-3



- Softkeys
    - Using the, 4-4
  - SP\_SET, 6-35
  - SP\_SET? remote command, 6-35
  - Special Functions Menu, 4-6
  - Specifications
    - AC voltage, dc offset, 1-29
    - Oscilloscope Calibration Option, 8-5, 8-60
    - Power uncertainty, 1-25
  - SPLSTR remote command, 6-36
  - SPLSTR? remote command, 6-36
  - Squarewave, 4-41
  - Squarewave and Duty Cycle, 4-42
  - SRC\_PREF remote command, 6-36
  - SRC\_PREF? remote command, 6-37
  - SRE
    - Programming the, 5-38
    - Register, 5-37
  - SRE remote command, 6-37
  - SRE? remote command, 6-37
  - SRQ, Service Request Line, 5-37
  - SRQSTR remote command, 6-37
  - SRQSTR? remote command, 6-38
  - Standard Equipment Table, 2-3
  - Status
    - Checking 5500A, 5-35
    - Register Overview - Figure, 5-36
    - Register Summary - Table, 5-35
    - Serial Poll Status Byte, 5-35
  - Status Commands**, 6-7
  - STB
    - Explained, 5-35
    - Programming the, 5-38
  - STB remote command, 6-38
  - STBY key, 3-5
  - STBY remote command, 6-38
  - Summary of Commands and Queries, 6-8
    - Oscilloscope Calibration Option, 8-34, 8-83
  - Syntax
    - Information, General, 5-31
    - Parameter Rules, 5-31
    - Response Messages, 5-34
- T—**
- Tab Characters, 5-32
  - Taking a Thermocouple Measurement, 5-46
  - TC\_MEAS remote command, 6-38
  - TC\_OFFSET remote command, 6-38
  - TC\_OFFSET? remote command, 6-39
  - TC\_OTCD remote command, 6-39
  - TC\_OTCD? remote command, 6-39
  - TC\_REF remote command, 6-39
  - TC\_REF? remote command, 6-40
  - TC\_TYPE remote command, 6-40
  - TC\_TYPE? remote command, 6-41
  - TC\_TYPE\_D remote command, 6-41
  - TC\_TYPE\_D? remote command, 6-42
  - TEMP\_STD remote command, 6-42
  - Temperature Simulation, 4-35
  - Temperature Simulation, RTD, 4-37
  - Terminators, 5-33
  - Testing a Model 41 Power Harmonics Analyzer, 4-58
  - Testing Harmonics Amps Performance, 4-61
  - Testing Harmonics Volts Performance, 4-60
  - Testing RS-232 Host Port Operation using a Terminal, 5-12
  - Testing RS-232 Host Port Operation using Visual Basic, 5-14
  - Testing RS-232 UUT Port Operation using Visual Basic, 5-18
  - Testing RS-232 UUT Port Operation via a Terminal, 5-17
  - Testing the IEEE-488 Port, 5-8
  - Testing the Meter, 4-53
  - Testing the RS-232 Host Port, 5-12
  - Testing the RS-232 UUT Port via IEEE-488 Port, 5-19
  - Testing the RS-232 UUT Port via RS-232 Host Port, 5-17
  - Testing the Thermometer, 4-62
  - Testing Watts, VA, VAR Performance, 4-58
  - Thermocouple
    - Measuring Temperatures, 4-39
  - Thermocouple (TC) Measurement Commands**, 6-7
    - Thermocouple Measurement Accuracy, 7-18
    - Thermocouple Measuring Accuracy, 7-18
    - Thermocouple Performance, 4-63
    - Thermocouple Sourcing Accuracy, 7-18
  - Time Marker
    - Oscilloscope Calibration, 8-27, 8-81
  - Time Marker Calibration, 8-26, 8-80
  - Time Marker Function, 8-26, 8-80
    - Specifications, 8-9
  - Trianglewave, 4-41
  - TRIG OUT key, 3-7
  - Trigger Specifications, 8-11, 8-64
  - Trigger Tests for Oscilloscope, 8-28, 8-82
  - Truncated Sinewave, 4-42
  - Truncated Waveform
    - Truncated, 4-42
  - TSENS\_TYPE remote command, 6-43
  - TSENS\_TYPE? remote command, 6-43
  - Turning on the Calibrator, 4-3
  - Types of Commands, 5-25
- U—**
- Unpacking, 2-3

- Using Commands, 5-25
- Using Multiply and Divide, 4-50
- Using the 5725A Amplifier, 4-47
- Using the Format EEPROM Menu, 4-6
- Using the Instrument Setup Menu, 4-5
- Using the Operate and Standby Modes, 4-8
- Using the Setup Menu, 4-4
- Using the Softkeys, 4-4
- Utility Functions Menu, 4-6
- UUT Connection: Capacitance (Compensation Off), 4-14
- UUT Connection: Capacitance (Four-Wire Compensation), 4-13
- UUT Connection: Capacitance (Two-Wire Compensation), 4-14
- UUT Connection: DC Voltage/AC Voltage, 4-15
- UUT Connection: Resistance (Compensation Off), 4-13
- UUT Connection: Resistance (Four-Wire Compensation), 4-12
- UUT Connection: Resistance (Two-Wire Compensation), 4-12
- UUT Connection: Temperature (RTD), 4-15
- UUT Connection: Temperature (Thermocouple), 4-16
- UUT Connections, 4-11
  - Connecting the Calibrator to a UUT, 4-9
- UUT Port
  - Controlling an Instrument, 5-46
- UUT\_FLUSH remote command, 6-44
- UUT\_RECV? remote command, 6-44
- UUT\_SEND remote command, 6-45
- UUT\_SET remote command, 6-46
- UUT\_SET? remote command, 6-46

## —V—

- V/DIV menu, 8-17, 8-70

- VAL? remote command, 6-47
- Volt Function, 8-16, 8-69
  - Specifications, 8-6, 8-60
  - V/DIV menu, 8-17, 8-70
- Voltage
  - Limit Setting, 4-51
  - Selecting Line, 2-4
  - Setting AC Output, 4-19
  - Setting DC output, 4-18
- Voltage Gain Calibration, 8-16, 8-18, 8-69, 8-71
- VVAL? remote command, 6-47

## —W—

- WAI remote command, 6-47
- Warming up the Calibrator, 4-4
- Watts Performance, Text Screen, 4-59
- Wave Generator, 8-28, 8-82
- WAVE remote command, 6-48
- WAVE? remote command, 6-48
- Waveform Types, 4-40
- Waveforms
  - Harmonics, 4-42
  - Setting Harmonics, 4-42
  - Sinewave, 4-41
  - Squarewave, 4-41
  - Trianglewave, 4-41
  - Truncated, 4-42
- Wavegen Menu, 8-28, 8-82
- When to Use EARTH, 4-10
- Where To Go From Here, 1-6

## —Z—

- ZCOMP remote command, 6-48
- ZCOMP? remote command, 6-49
- Zeroing the Calibrator, 4-7