

Keysight N1913/1914A EPM Series Power Meters

Notices

Copyright Notice

© Keysight Technologies 2009–2018

No part of this manual may be reproduced in any form or by any means (including electronic storage and retrieval or translation into a foreign language) without prior agreement and written consent from Keysight Technologies as governed by United States and international copyright laws.

Manual Part Number

N1913-90001

Edition

Edition 20, February 12, 2018

Printed in:

Printed in Malaysia

Published by:

Keysight Technologies
Bayan Lepas Free Industrial Zone,
11900 Penang, Malaysia

Technology Licenses

The hardware and/or software described in this document are furnished under a license and may be used or copied only in accordance with the terms of such license.

Declaration of Conformity

Declarations of Conformity for this product and for other Keysight products may be downloaded from the Web. Go to <http://www.keysight.com/go/conformity>. You can then search by product number to find the latest Declaration of Conformity.

U.S. Government Rights

The Software is “commercial computer software,” as defined by Federal Acquisition Regulation (“FAR”) 2.101. Pursuant to FAR 12.212 and 27.405-3 and Department of Defense FAR Supplement (“DFARS”) 227.7202, the U.S. government acquires commercial computer software under the same terms by which the software is customarily provided to the public. Accordingly, Keysight provides the Software to U.S. government customers under its standard commercial license, which is embodied in its End User License Agreement (EULA), a copy of which can be found at <http://www.keysight.com/find/sweula>. The license set forth in the EULA represents the exclusive authority by which the U.S. government may use, modify, distribute, or disclose the Software. The EULA and the license set forth therein, does not require or permit, among other things, that Keysight: (1) Furnish technical information related to commercial computer software or commercial computer software documentation that is not customarily provided to the public; or (2) Relinquish to, or otherwise provide, the government rights in excess of these rights customarily provided to the public to use, modify, reproduce, release, perform, display, or disclose commercial computer software or commercial computer software documentation. No additional government requirements beyond those set forth in the EULA shall apply, except to the extent that those terms, rights, or licenses are explicitly required from all providers of commercial computer software pursuant to the FAR and the DFARS and are set forth specifically in writing elsewhere in the EULA. Keysight shall be under no obligation to update, revise or otherwise modify the Software. With respect to any technical data as defined by FAR 2.101, pursuant to FAR 12.211 and 27.404.2 and DFARS 227.7102, the U.S. government acquires no greater than Limited Rights as defined in FAR 27.401 or DFAR 227.7103-5 (c), as applicable in any technical data.

Warranty

THE MATERIAL CONTAINED IN THIS DOCUMENT IS PROVIDED “AS IS,” AND IS SUBJECT TO BEING CHANGED, WITHOUT NOTICE, IN FUTURE EDITIONS. FURTHER, TO THE MAXIMUM EXTENT PERMITTED BY APPLICABLE LAW, KEYSIGHT DISCLAIMS ALL WARRANTIES, EITHER EXPRESS OR IMPLIED, WITH REGARD TO THIS MANUAL AND ANY INFORMATION CONTAINED HEREIN, INCLUDING BUT NOT LIMITED TO THE IMPLIED WARRANTIES OF MERCHANTABILITY AND FITNESS FOR A PARTICULAR PURPOSE. KEYSIGHT SHALL NOT BE LIABLE FOR ERRORS OR FOR INCIDENTAL OR CONSEQUENTIAL DAMAGES IN CONNECTION WITH THE FURNISHING, USE, OR PERFORMANCE OF THIS DOCUMENT OR OF ANY INFORMATION CONTAINED HEREIN. SHOULD KEYSIGHT AND THE USER HAVE A SEPARATE WRITTEN AGREEMENT WITH WARRANTY TERMS COVERING THE MATERIAL IN THIS DOCUMENT THAT CONFLICT WITH THESE TERMS, THE WARRANTY TERMS IN THE SEPARATE AGREEMENT SHALL CONTROL.

Safety Information

CAUTION

A CAUTION notice denotes a hazard. It calls attention to an operating procedure, practice, or the like that, if not correctly performed or adhered to, could result in damage to the product or loss of important data. Do not proceed beyond a CAUTION notice until the indicated conditions are fully understood and met.

WARNING

A WARNING notice denotes a hazard. It calls attention to an operating procedure, practice, or the like that, if not correctly performed or adhered to, could result in personal injury or death. Do not proceed beyond a WARNING notice until the indicated conditions are fully understood and met.

Certification

Keysight Technologies certifies that this product met its published specifications at the time of shipment. Keysight further certifies that its calibration measurements are traceable to the United States National Institute of Standard and Technology (formerly National Bureau of Standards), to the extent allowed by that organization's calibration facility, and to the calibration facilities of other International Standards Organization members.

General Warranty

The material contained in this document is provided "as is," and is subject to being changed, without notice, in future editions. Further, to the maximum extent permitted by applicable law, Keysight disclaims all warranties, either express or implied with regard to this manual and any information contained herein, including but not limited to the implied warranties of merchantability and fitness for a particular purpose. Keysight shall not be liable for errors or for incidental or consequential damages in connection with the furnishing, use, or performance of this document or any information contained herein. Should Keysight and the user have a separate written agreement with warranty terms covering the material in this document that conflict with these terms, the warranty terms in the separate agreement shall control. Duration and conditions of warranty for this product may be superseded when the product is integrated into (becomes a part of) other Keysight products. During the warranty period, Keysight will, at its option, either repair or replace products which prove to be defective. The warranty period begins on the date of delivery or on the date of installation if installed by Keysight.

Warranty Service

For warranty service or repair, this product must be returned to a service facility designated by Keysight. For products returned to Keysight for warranty service, the Buyer shall prepay shipping charges to Keysight and Keysight shall pay shipping charges to return the product to the Buyer. However, the Buyer shall pay all shipping charges, duties, and taxes for products returned to Keysight from another country.

Limitation of Warranty

The foregoing warranty shall not apply to defects resulting from improper or inadequate maintenance by the Buyer, Buyer-supplied products or interfacing, unauthorized modification or misuse, operation outside of the environmental specifications for the product, or improper site preparation or maintenance.

The design and implementation of any circuit on this product is the sole responsibility of the Buyer. Keysight does not warrant the Buyer's circuitry or malfunctions of Keysight products that result from the Buyer's circuitry. In addition, Keysight does not warrant any damage that occurs as a result of the Buyer's circuit or any defects that result from Buyer-supplied products.

To the extent allowed by local law, Keysight makes no other warranty, expressed or implied, whether written or oral with respect to this product and specifically disclaims any implied warranty or condition of merchantability, fitness for a particular purpose or satisfactory quality.

Exclusive Remedies

To the extent allowed by local law, the remedies provided herein are the Buyer's sole and exclusive remedies. Keysight shall not be liable for any direct, indirect, special, incidental, or consequential damages (including lost profit or data), whether based on warranty, contract, tort, or any other legal theory.

Restricted Rights Legend

The Software and Documentation have been developed entirely at private expense. They are delivered and licensed as “commercial computer software” as defined in DFARS 252.227-7013 (Oct 1988), DFARS 252.211-7015 (May 1991), or DFARS 252.227-7014 (Jun 1995), as a “commercial item” as defined in FAR 2.101(a), or as “restricted computer software” as defined in FAR 52.227-19 (Jun 1987) (or any equivalent agency regulation or contract clause), whichever is applicable. You have only those rights provided for such Software and Documentation by the applicable FAR or DFARS clause or the Keysight standard software agreement for the product involved.

Technology Licenses

The hardware and/or software described in this document are furnished under a license and may be used or copied only in accordance with the terms of such license.

Safety Summary

The following general safety precautions must be observed during all phases of operation of this instrument. Failure to comply with these precautions or with specific warnings elsewhere in this manual violates safety standards of design, manufacture, and intended use of the instrument. Keysight Technologies assumes no liability for the customer's failure to comply with these requirements.

Safety Notices

WARNING















A **WARNING** notice denotes a hazard. It calls attention to an operating procedure, practice, or the like that, if not correctly performed or adhered to, could result in personal injury or loss of life. Do not proceed beyond a **WARNING** notice until the indicated conditions are fully understood and met.





CAUTION

A **CAUTION** notice denotes a hazard. It calls attention to an operating procedure, practice, or the like that, if not correctly performed or adhered to, could result in damage to the product or loss of important data. Do not proceed beyond a **CAUTION** notice until the indicated conditions are fully understood and met.

Safety Symbols

The following symbols on the instrument and in the documentation indicate precautions which must be taken to maintain safe operation of the instrument.

| | |
|---|--|
|  <p>Caution, risk of danger. The Instruction Documentation Symbol. The instrument is marked with this symbol when it is necessary for the user to refer to the instructions in the supplied documentation.</p> |  <p>This symbol indicates the operating switch for 'Stand-by' mode. Note, this instrument is NOT isolated from the mains when the switch is pressed. To isolate the instrument, the mains coupler (mains input cord) should be removed from the power supply.</p> |
|  <p>Alternating current (AC)</p> |  <p>Instrument protected throughout by DOUBLE INSULATION or REINFORCED INSULATION.</p> |
|  <p>Direct current (DC)</p> |  <p>On (Supply)</p> |
|  <p>Both direct and alternating current</p> |  <p>Off (Supply)</p> |
|  <p>Three-phase alternating current</p> |  <p>Caution, risk of electric shock</p> |
|  <p>Earth (ground) TERMINAL</p> |  <p>Caution, hot surface</p> |
|  <p>PROTECTIVE CONDUCTOR TERMINAL</p> |  <p>In position of bi-stable push control</p> |

| | |
|--|--|
|  <p>Frame or chassis TERMINAL</p> |  <p>Out position of bi-stable push control</p> |
|  <p>Equipotentiality</p> |  <p>This symbol indicates that a device, or part of a device, may be susceptible to electrostatic discharges (ESD) which can result in damage to the product. Observe ESD precautions given on the product, or its user documentation, when handling equipment bearing this mark.</p> |

General Safety Information

This is a Safety Class I instrument (provided with a protective earthing ground, incorporated in the power cord). The mains plug shall only be inserted in a socket outlet provided with a protective earth contact. Any interruption of the protective conductor inside or outside of the instrument is likely to damage the meter. Intentional interruption is prohibited.

WARNING

- Do not operate the instrument in an explosive atmosphere or in the presence of flammable gasses or fumes.
 - Do not use repaired fuses or short-circuited fuseholders: For continued protection against fire, replace the line fuse(s) only with fuse(s) of the same voltage and current rating and type.
 - Do not perform procedures involving cover or shield removal unless you are qualified to do so: Operating personnel must not remove the meter covers or shields. Procedures involving the removal of covers and shields are for use by service-trained personnel only.
 - Do not service or adjust alone: Under certain conditions, dangerous voltages may exist even with the instrument switched off. To avoid electrical shock, service personnel must not attempt internal service or adjustment unless another person, capable of rendering first aid and resuscitation, is present.
 - Do not operate damaged instrument: Whenever it is possible that the safety protection features built into this instrument have been impaired, either through physical damage, excessive moisture, or any other reason, REMOVE POWER and do not use the instrument until safe operation can be verified by service-trained personnel. If necessary, return the instrument to a Keysight Technologies Sales and Service Office for service and repair to ensure the safety features are maintained.
 - Do not substitute parts or modify the instrument: Because of the danger of introducing additional hazards, do not install substitute parts or perform any unauthorized modification to the instrument. Return the instrument to a Keysight Technologies Sales and Service Office for service and repair to ensure the safety features are maintained.
-

Environmental Conditions

The N1913/1914A is designed for indoor use and in an area with low condensation. The table below shows the general environmental requirements for this instrument.

| Environmental condition | Requirement |
|-------------------------|--|
| Temperature | Operating condition – 0 °C to 55 °C |
| | Storage condition – -40 °C to 70 °C |
| Humidity | Operating condition – Up to 95% RH at 40°C (non-condensing) |
| | Storage condition – Up to 90% RH at 65°C (non-condensing) |
| Altitude | Up to 4600 m |
| Pollution degree | 2 |

Regulatory Information

The N1913/1914A EPM Series power meters comply with the following safety and Electromagnetic Compatibility (EMC) compliances:







Safety compliance

- IEC 61010-1:2010/EN 61010-1:2010 (3rd Edition)
- Canada: CAN/CSA-C22.2 No. 61010-1-12
- USA: ANSI/UL 61010-1 (3rd Edition)

EMC compliance

- IEC 61326-1:2005/EN 61326-1:2006
- CISPR11:2003/EN 55011:2007, Group 1 Class A
- Canada: ICES/NMB-001:Issue 4, June 2006
- Australia/New Zealand: AS/NZS CISPR 11:2004

Regulatory Markings

| | |
|--|--|
|  <p>The CE mark is a registered trademark of the European Community. This CE mark shows that the product complies with all the relevant European Legal Directives.</p> <p>ICES/NMB-001 indicates that this ISM device complies with the Canadian ICES-001.</p> <p>Cet appareil ISM est conforme a la norme NMB-001 du Canada.</p> <p>ISM GRP.1 Class A indicates that this is an Industrial Scientific and Medical Group 1 Class A product.</p> |  <p>The CSA mark is a registered trademark of the Canadian Standards Association.</p> |
|  <p>This symbol is a South Korean Class A EMC Declaration. This is a Class A instrument suitable for professional use and in electromagnetic environment outside of the home.</p> |  <p>The RCM mark is a registered trademark of the Australian Communications and Media Authority.</p> |
|  <p>This symbol indicates the time period during which no hazardous or toxic substance elements are expected to leak or deteriorate during normal use. Forty years is the expected useful life of the product.</p> |  <p>This instrument complies with the WEEE Directive (2002/96/EC) marking requirement. This affixed product label indicates that you must not discard this electrical or electronic product in domestic household waste.</p> |

Waste Electrical and Electronic Equipment (WEEE) Directive 2002/96/EC

This instrument complies with the WEEE Directive (2002/96/EC) marking requirement. This affixed product label indicates that you must not discard this electrical or electronic product in domestic household waste.

Product category:

With reference to the equipment types in the WEEE directive Annex 1, this instrument is classified as a “Monitoring and Control Instrument” product.

The affixed product label is as shown below.



Do not dispose in domestic household waste.

To return this unwanted instrument, contact your nearest Keysight Service Center, or visit <http://about.keysight.com/en/companyinfo/environment/takeback.shtml> for more information.

Sales and Technical Support

To contact Keysight for sales and technical support, refer to the support links on the following Keysight websites:

- www.keysight.com/find/epm
(product-specific information and support, software and documentation updates)
- www.keysight.com/find/assist
(worldwide contact information for repair and service)

Table of Contents

| | |
|---|----|
| Certification | 3 |
| General Warranty | 3 |
| Warranty Service | 3 |
| Limitation of Warranty | 4 |
| Exclusive Remedies | 4 |
| Restricted Rights Legend | 5 |
| Technology Licenses | 5 |
| Safety Summary | 6 |
| Safety Notices | 6 |
| Safety Symbols | 7 |
| General Safety Information | 9 |
| Environmental Conditions | 10 |
| Regulatory Information | 10 |
| Regulatory Markings | 11 |
| Waste Electrical and Electronic Equipment (WEEE) Directive 2002/96/ EC | 12 |
| Product category: | 12 |
| Sales and Technical Support | 12 |
| 1 Introduction | |
| LXI Class-C Compliant Power Meter | 26 |
| Rack Mounting | 26 |
| Power Meter and Sensor Capability | 27 |
| Specifications | 27 |
| Conventions Used in this Guide | 28 |
| Front Panel Keys and Connections | 29 |
| The Display Layout | 34 |
| Window Symbols and Pop-ups | 37 |

| | |
|--|----|
| Warning Symbol Pop-up | 37 |
| Wait Symbol Pop-up | 38 |
| Confirm Symbol Pop-up | 38 |
| Numeric Entry Pop-up | 38 |
| Text Entry Pop-up | 39 |
| List Pop-up | 39 |
| Rear Panel Connections | 40 |
| Using the Instrument Web Interface | 41 |
| Using the Remote Front Panel | 45 |
| Editing the Instrument's LAN Settings | 46 |
| Capturing the Screen Image | 49 |
| Getting the Instrument Data | 50 |
| Making Socket Connection | 51 |
| Programming Language Selection (Option 200) | 53 |
| 2 General Power Meter Functions | |
| Setting the Units of Measurement | 56 |
| Setting the Measurement Frequency | 57 |
| Setting the Resolution | 58 |
| Making Relative Measurements | 59 |
| Setting Offsets | 61 |
| Setting Channel Offsets | 62 |
| Setting Display Offsets | 63 |
| Setting Frequency Dependent Offsets | 65 |
| Editing Frequency Dependent Offset Tables | 68 |
| Selectable Frequency Dependent Offset Unit (dB or %) | 71 |
| Setting Measurement Averaging | 73 |
| Step Detection | 75 |
| Measuring Pulsed Signals | 76 |
| Setting External Trigger for Average Power Measurement | 79 |
| Power Sweep Mode | 80 |
| Frequency Sweep Mode | 84 |
| Determine the Right Step to be Set | 86 |

| | |
|--|-----|
| Setting Measurement Limits | 87 |
| Setting Limits | 88 |
| Checking for Limit Failures | 90 |
| Numeric Format | 91 |
| Single Function Measurement | 92 |
| Combined Measurement | 93 |
| Max Hold/Min Hold | 94 |
| Recorder Output | 97 |
| Saving and Recalling Power Meter States | 100 |
| Editing a Register's Name | 101 |
| Recalling a Measurement Setup | 101 |
| Zeroing and Calibrating the Power Meter | 102 |
| Zeroing the Power Meter | 102 |
| Zero/Cal Lockout | 103 |
| Calibration | 104 |
| Calibration Procedure Using E-Series Power Sensors and N8480 Series Power Sensors (excluding Option CFT) | 105 |
| Calibration Procedure Using 8480 Series Power Sensors and N8480 Series Power Sensors (with Option CFT) | 106 |
| Adapter Test Procedure | 109 |
| Blank Screen | 112 |
| Secure Blank | 113 |
| Backlight Intensity Control | 118 |
| Memory Erase/Secure Erase | 119 |
| VGA Output (Optional) | 122 |
| Warm Start | 123 |
| Battery Information (Optional) | 124 |
| Running Under Battery Power | 124 |
| Battery Menu | 125 |
| Battery General Information | 128 |
| Setting the Cable Short/Long | 130 |

3 Using E9300 E-Series Power Sensors

| | |
|--|-----|
| Introduction | 132 |
| Power Meter Configuration | 133 |
| Default Channel Setup | 134 |
| Measurement Accuracy | 135 |
| Measuring Spread Spectrum and Multitone Signals | 138 |
| CDMA Signal Measurements | 139 |
| Multitone Signal Measurements | 140 |
| Measuring TDMA Signals | 141 |
| Power Meter and Sensor Operation | 141 |
| Achieving Stable Results with TDMA Signals | 141 |
| Achieving Stable Results with GSM Signals | 142 |
| Electromagnetic Compatibility (EMC) Measurements | 143 |
| Measurement Accuracy and Speed | 144 |
| Setting the Range | 144 |
| Measurement Considerations | 145 |
| 4 Using E4410 E-Series Power Sensors | |
| Introduction | 148 |
| Power Meter Configuration | 149 |
| Default Channel Setup | 150 |
| Measurement Accuracy | 151 |
| 5 Using 8480 Series Power Sensors | |
| Introduction | 154 |
| Power Meter Configuration | 155 |
| Default Channel Setup | 156 |
| 8480 Series Sensors Connection Requirements | 157 |
| Measurement Accuracy | 158 |
| Frequency Specific Calibration Factors | 159 |
| Sensor Calibration Tables | 163 |
| Editing/Generating Sensor Calibration Tables | 166 |
| Pre-installed Calibration Table Contents | 170 |

| | | |
|----------|--|-----|
| 6 | Using N8480 Series Power Sensors | |
| | Introduction | 176 |
| | Power Meter Configuration Changes | 177 |
| | Default Channel Setup | 178 |
| | N8480 Series Sensors Connection Requirements | 179 |
| | N8480 Series Power Sensors (excluding Option CFT) | 180 |
| | N8480 Series Power Sensors with Option CFT | 182 |
| | Frequency Specific Calibration Factors | 182 |
| | Sensor Calibration Tables | 187 |
| | Selecting a Sensor Calibration Table | 188 |
| | Editing/Generating Sensor Calibration Tables | 191 |
| 7 | Using U2000 Series USB Power Sensors | |
| | Introduction | 196 |
| | Power Meter Configuration | 197 |
| | Default Channel Setup | 199 |
| | Measurement Accuracy | 200 |
| | Electromagnetic Compatibility (EMC) Measurements | 202 |
| | Measurement Accuracy and Speed | 203 |
| | Setting the Range | 203 |
| | Measurement Considerations | 204 |
| 8 | Using U8480 Series USB Thermocouple Sensors | |
| | Introduction | 208 |
| | Power Meter Configuration | 209 |
| | Default Channel Setup | 210 |
| | Measurement Accuracy | 211 |
| | Zeroing | 213 |
| | Calibrating | 215 |
| | Zero+Cal | 217 |
| | FDO Table Editing | 217 |
| | Reference Manual | 218 |

9 Maintenance

| | |
|--|-----|
| Self Test | 220 |
| Front Panel Selection of Self Tests | 220 |
| Instrument Self Test | 221 |
| Remote Testing | 222 |
| Test Descriptions | 222 |
| Error Messages | 224 |
| Introduction | 224 |
| Error Message List | 226 |
| Operator Maintenance | 233 |
| Replacing the Power Line Fuse | 233 |
| Connector Maintenance | 234 |
| Contacting Keysight Technologies | 235 |
| Before calling Keysight Technologies | 235 |
| Check the Basics | 236 |
| Instrument serial numbers | 236 |
| Recommended Calibration Interval | 237 |
| Erasing Memory Data | 238 |
| Returning Your Power Meter for Service | 239 |
| Packaging the Power Meter for Shipment | 239 |
| | 240 |

10 Characteristics and Specifications

List of Figures

| | | |
|-------------|---|----|
| Figure 1-1 | Dual numeric display | 34 |
| Figure 1-2 | Single numeric and analog display | 35 |
| Figure 1-3 | Full screen numeric display | 36 |
| Figure 1-4 | Accessing the instrument Web interface | 41 |
| Figure 1-5 | N1914A EPM Series power meter Web interface (Welcome Page) | 42 |
| Figure 1-6 | Message to identify the instrument | 43 |
| Figure 1-7 | Example of Lan Status message | 44 |
| Figure 1-8 | Viewing LAN configuration settings from the Web interface | 46 |
| Figure 1-9 | Password security dialog box | 47 |
| Figure 1-10 | Changing the instrument LAN interface configuration | 48 |
| Figure 1-11 | Manual Configuration window | 51 |
| Figure 1-12 | Power meter successfully connected via socket connection | 52 |
| Figure 2-1 | Frequency pop-up | 57 |
| Figure 2-2 | Typical relative measurement display | 59 |
| Figure 2-3 | Numeric display | 60 |
| Figure 2-4 | Simplified measurement path | 61 |
| Figure 2-5 | Typical channel offset display | 62 |
| Figure 2-6 | Channel offset indicator | 63 |
| Figure 2-7 | Typical display offset display | 64 |
| Figure 2-8 | Frequency dependent offset tables display | 66 |
| Figure 2-9 | Frequency dependent offset indicator | 67 |
| Figure 2-10 | “Edit Offset” display with data added | 69 |
| Figure 2-11 | Edit table title pop-up | 69 |
| Figure 2-12 | Changing offset unit | 70 |
| Figure 2-13 | Offset display in engineering unit (when the selected unit is %) | 72 |
| Figure 2-14 | Typical averaged readings | 73 |
| Figure 2-15 | Meas Avg Count pop-up | 74 |
| Figure 2-16 | Pulsed signal | 76 |
| Figure 2-17 | Duty cycle setting | 77 |
| Figure 2-18 | Duty cycle indicator | 77 |

| | | |
|-------------|--|-----|
| Figure 2-19 | TRIG IN and TRIG OUT connection diagram between power meter and power source | 80 |
| Figure 2-20 | Channel Setup display | 81 |
| Figure 2-21 | Trigger setting menu 1 of 2 | 82 |
| Figure 2-22 | Trigger setting menu 2 of 2 | 82 |
| Figure 2-23 | Limits checking applications | 87 |
| Figure 2-24 | Limits checking results | 87 |
| Figure 2-25 | Minimum limit pop-up | 89 |
| Figure 2-26 | Limit failures | 90 |
| Figure 2-27 | Measurement Setup showing single configuration | 91 |
| Figure 2-28 | Function pop-up | 92 |
| Figure 2-29 | Measurement Setup showing combined configuration | 93 |
| Figure 2-30 | Measurement example display | 93 |
| Figure 2-31 | Max hold/min hold measurement is performed on the 'HOLD' block | 94 |
| Figure 2-32 | Hold pop-up | 95 |
| Figure 2-33 | Min Hold and Max Hold measurement mode indicated in the display | 95 |
| Figure 2-34 | Measurement mode in full word | 96 |
| Figure 2-35 | Recorder Minimum pop-up | 98 |
| Figure 2-36 | Recorder Maximum pop-up | 99 |
| Figure 2-37 | Save/Recall screen | 100 |
| Figure 2-38 | Save confirm pop-up | 100 |
| Figure 2-39 | File name pop-up | 101 |
| Figure 2-40 | Recall pop-up | 101 |
| Figure 2-41 | Zeroing pop-up | 102 |
| Figure 2-42 | Please zero and calibrate window | 103 |
| Figure 2-43 | Calibration wait pop-up | 104 |
| Figure 2-44 | System calibration setup | 110 |
| Figure 2-45 | Blank screen | 112 |
| Figure 2-46 | Secure Blank feature | 113 |
| Figure 2-47 | Enter 6-digit Password pop-up | 114 |
| Figure 2-48 | 6-digit password entered | 114 |
| Figure 2-49 | Warning message | 115 |
| Figure 2-50 | Reconfirm password | 115 |
| Figure 2-51 | Warning message | 116 |

| | | |
|-------------|--|-----|
| Figure 2-52 | Password reconfirmation pop-up | 116 |
| Figure 2-53 | Enter password to restore display | 117 |
| Figure 2-54 | Backlight intensity control | 118 |
| Figure 2-55 | Increase or decrease the backlight brightness | 118 |
| Figure 2-56 | Activate memory erase using combo keys | 119 |
| Figure 2-57 | Secure Erase | 120 |
| Figure 2-58 | Confirmation to begin secure erase | 120 |
| Figure 2-59 | Warning pop-up | 121 |
| Figure 2-60 | VGA toggle ON/OFF | 122 |
| Figure 2-61 | Enable/disable warm start feature | 123 |
| Figure 2-62 | “Running under battery power” pop-up | 124 |
| Figure 2-63 | Battery indicator | 125 |
| Figure 2-64 | Battery menu | 125 |
| Figure 2-65 | Battery status display | 126 |
| Figure 2-66 | Low battery indicator | 126 |
| Figure 2-67 | Display backlight control | 127 |
| Figure 2-68 | Short/long cable option | 130 |
| Figure 3-1 | E9300 E-Series auto-averaging settings | 133 |
| Figure 3-2 | E9300 E-Series sensor default channel setup | 134 |
| Figure 3-3 | Frequency pop-up | 137 |
| Figure 3-4 | Spread spectrum signal | 138 |
| Figure 3-5 | Wideband CDMA error of E-Series E9300 power sensor versus corrected CW sensor | 139 |
| Figure 3-6 | CDMA (IS-95A): 9Ch Fwd | 139 |
| Figure 3-7 | Calibration factors versus frequency | 140 |
| Figure 4-1 | E-Series CW sensor auto-averaging settings | 149 |
| Figure 4-2 | E-Series E4410 sensor default channel setup | 150 |
| Figure 4-3 | Frequency pop-up | 152 |
| Figure 5-1 | 8480 Series auto-averaging settings | 155 |
| Figure 5-2 | 8480 Series sensor default channel setup | 156 |
| Figure 5-3 | Reference Calibration Factor pop-up window | 160 |
| Figure 5-4 | Calibration factor pop-up window | 161 |
| Figure 5-5 | Calibration factor display | 161 |
| Figure 5-6 | Sensor table selected | 164 |
| Figure 5-7 | Frequency dependent offset indicator | 164 |
| Figure 5-8 | Frequency/calibration table display | 165 |
| Figure 5-9 | “Sensor Tbls” screen | 167 |

| | | |
|-------------|--|-----|
| Figure 5-10 | “Edit Cal” display | 168 |
| Figure 5-11 | Edit table title pop-up | 168 |
| Figure 6-1 | Auto-averaging settings | 177 |
| Figure 6-2 | N8480 Series sensor (excluding Option CFT) default channel setup | 178 |
| Figure 6-3 | N8480 Series sensor with Option CFT default channel setup | 178 |
| Figure 6-4 | Frequency pop-up | 181 |
| Figure 6-5 | Reference calibration factor pop-up window | 183 |
| Figure 6-6 | Calibration factor pop-up window | 184 |
| Figure 6-7 | Calibration factor displayed | 185 |
| Figure 6-8 | Sensor table selected | 188 |
| Figure 6-9 | Frequency dependent offset indicator | 189 |
| Figure 6-10 | Frequency/calibration table display | 190 |
| Figure 6-11 | “Sensor Tbls” screen | 192 |
| Figure 6-12 | “Edit Cal” display | 193 |
| Figure 6-13 | Edit table title pop-up | 193 |
| Figure 7-1 | U2000 Series auto-averaging settings | 198 |
| Figure 7-2 | .. U2000 Series USB power sensor default channel setup | 199 |
| Figure 7-3 | Frequency pop-up | 201 |
| Figure 8-1 | U8480 Series auto-averaging settings | 209 |
| Figure 8-2 | U8480 Series USB power sensor default channel setup | 210 |
| Figure 8-3 | Frequency pop-up | 212 |
| Figure 8-4 | Zeroing pop-up message | 213 |
| Figure 8-5 | Zeroing error pop-up message | 214 |
| Figure 8-6 | Calibration type | 215 |
| Figure 8-7 | Calibration pop-up message | 216 |
| Figure 8-8 | Calibration error pop-up message | 216 |
| Figure 8-9 | FDO table editing | 217 |
| Figure 8-10 | Reference manual softkey | 218 |
| Figure 8-11 | QR code screen | 218 |
| Figure 9-1 | Self test complete | 221 |
| Figure 9-2 | Error indicator position | 224 |
| Figure 9-3 | Replacing the fuses | 233 |
| Figure 9-4 | Secure erase status pop-up | 238 |

List of Tables

| | | |
|-----------|---|-----|
| Table 1-1 | Type of Lan Status message | 43 |
| Table 2-1 | Measurement units - Single channel meters | 56 |
| Table 2-2 | Measurement units - Dual channel meters | 56 |
| Table 2-3 | Range of values for window limits | 88 |
| Table 2-4 | Ranges of recorder output setting | 99 |
| Table 2-5 | Power Sensor Connection Requirements | 107 |
| Table 2-6 | Equipment list | 109 |
| Table 2-7 | Typical specifications | 109 |
| Table 3-1 | Power sensor connection requirements | 135 |
| Table 5-1 | 8480 Series connection requirements | 157 |
| Table 5-2 | Installed power sensor models | 166 |
| Table 6-1 | Power range in the Range setting | 176 |
| Table 6-2 | N8480 Series connection requirements | 179 |
| Table 6-3 | Installed power sensor models | 191 |
| Table 7-1 | Power sensor connection requirements | 200 |

THIS PAGE HAS BEEN INTENTIONALLY LEFT BLANK.

1 Introduction

| | |
|---|----|
| LXI Class-C Compliant Power Meter | 26 |
| Rack Mounting | 26 |
| Power Meter and Sensor Capability | 27 |
| Conventions Used in this Guide | 28 |
| Front Panel Keys and Connections | 29 |
| The Display Layout | 34 |
| Window Symbols and Pop-ups | 37 |
| Rear Panel Connections | 40 |
| Using the Instrument Web Interface | 41 |
| Making Socket Connection | 51 |
| Programming Language Selection (Option 200) | 53 |

This chapter introduces you to the front panel display and instrument Web browser of the N1913/1914A EPM Series power meter.

LXI Class-C Compliant Power Meter



The N1913/1914A EPM Series power meter is a **LXI Class C** compliant instrument, developed using LXI Technology. LXI, an acronym for LAN eXtension for Instrumentation, is an instrument standard for devices that use the Ethernet (LAN) as their primary communication interface.

Hence, it is an easy-to-use instrument especially with the usage of an integrated Web browser that provides a convenient way to configure the instrument's functionality.

Rack Mounting

The N1913/1914A can be mounted in a standard 19-inch rack. Rack mount kits are available as listed below. Support rails are also required for rack mounting. These are normally supplied with the rack and are not included with the rack mount options.

If you are installing an instrument on top of the N1913/1914A, ensure that the instrument does not obstruct the ventilation holes at the top of the N1913/1914A. If required, use a filler panel above the N1913/1914A to ensure adequate space for air circulation.

| Option | Description |
|-------------------|------------------------------------|
| N1913A Option 908 | Rack mount kit for one instrument |
| N1913A Option 909 | Rack mount kit for two instruments |
| N1914A Option 908 | Rack mount kit for one instrument |
| N1914A Option 909 | Rack mount kit for two instruments |

Power Meter and Sensor Capability

Your N1913/1914A EPM Series power meter is compatible with the Keysight E9300 E-Series, E4410 E-Series, 8480 Series, N8480 Series, U2000 Series, and the U8480 Series thermocouple sensor. However, not all sensor and meter combinations have the same features or capabilities. The main differences are as below:

| Features | E-Series E9300 | E-Series E4410 | 8480 Series | N8480 Series | U2000 Series | U8480 Series |
|--|-------------------|-------------------|----------------|------------------|-----------------|-----------------|
| Average power of CW signal | • | • | • | • | • | • |
| Average power of modulated signal | • | | • | • | • | • |
| Cal factors stored on EEPROM | • | • | | • ^[a] | • | • |
| Correction factors stored in a 3 MB Flash memory | | | | | • | • |
| ≥200 readings/sec | • | • | | | | |

[a] Not applicable for N8480 Series power sensors with Option CFT

Specifications

The specifications for the power meter are listed in [Chapter 10, "Characteristics and Specifications,"](#) starting on page 241.

Conventions Used in this Guide

The following conventions are used throughout this guide.





| | |
|---|--|
|  | This symbol and text represents a labeled key on the power meter front panel. |
| Softkey | This symbol and text represents a labeled softkey and is used to indicate that you should press the unmarked key beside the displayed text. |
| Message | This text represents a displayed message. |
| Parameter | This is used to represent a parameter, value, or title. |
| “Channel” | <p>This User’s Guide describes the operation for both the single channel and the dual channel power meter. To identify channels on a dual channel meter a Channel softkey on an N1913A meter becomes Channel A and Channel B on an N1914A.</p> <p>When you are asked to press “the channel” Softkey in a procedure, make sure you select the relevant channel.</p> |

Front Panel Keys and Connections

This section briefly describes the functions of the front panel keys and connectors.



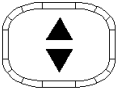
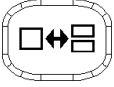



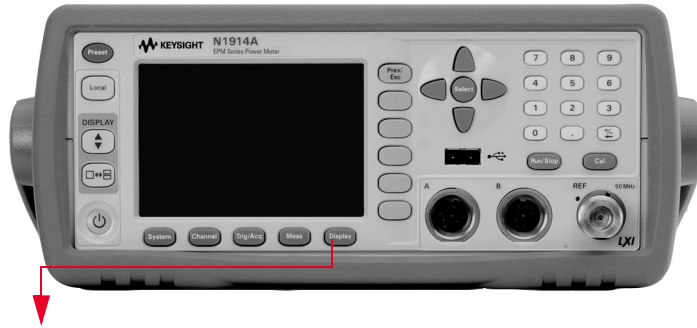

These keys are located to the left of the display.

| Key | Function |
|---|---|
|  | Press this key to preset the power-meter to the default setting. |
|  | Press this key to control the power meter from the front panel when it is operating via the remote interfaces (when Local Lock Out is not enabled). |
|  | Press this key to select the upper or lower measurement window. The selected window is highlighted by a blue line on the right side of the window. Any measurement setup you create is performed in the selected window. |
|  | Press this key to choose windowed, expanded, or full-screen display of a numeric measurement. |
|  | Press this key to switch the meter between on and standby. When power is supplied, the background LED is red. Pressing the key, switches the power meter on and the background LED is green. When the meter is powered on, the start-up will take approximately 25 seconds. |



These keys are located along the lower edge of the display.

| Key | Function |
|---|--|
|  | Press this key to access general configuration-menus, such as GPIB address. You can also access some measurement configuration menus. The measurement screen remains visible. |
|  | Press this key to access the channel configuration menus. Channel parameters such as averaging and offsets are configured from this menu. |
|  | Press this key to access the triggering menu. The triggering feature will be made available in future for power sensors with triggering capability. |
|  | Press this key to setup relative measurements or set display offsets. Use this key to configure the selected measurement. |
|  | Press this key to access the measurement display menu. You can choose the displayed measurement resolution, units and display format. Use this key together with  to configure measurement displays. |





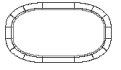
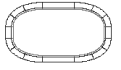
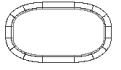
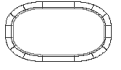
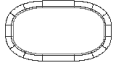
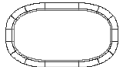



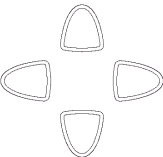

These keys are all associated with the menu labels and data entry. They are located to the right of the display.

| Key | Function |
|---|---|
|  | Press this key to return to the previous screen. This key also cancels pop-up entry. |
|      | These unmarked keys are called 'softkeys' and are referred to by the text on the display next to them. For example, during a Preset, you are given an option to confirm the command. Press Confirm to continue, that is, press the softkey beside the displayed word 'confirm'. |
|  | The lowest of the unmarked softkeys is used when there is a two page menu to be displayed. For example, a 1 of 2 is displayed beside the key indicating the first page of a two page menu. Press the key to access the next page or second page. (A 2 of 2 is displayed). |

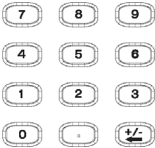

These keys and connectors are associated with the measurement channels and are located on the right-hand side of the front panel.

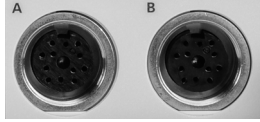
| Key | Function |
|---|---|
|  | The arrow keys are used for navigation around the parameter entry screens. The up and down arrows are used for selecting values from a pop-up list. They are also used to enter text, for example, table names. |
|  | Press this key to select a highlighted field to allow data entry, check a checkbox and terminate entry of a pop-up list. |
|  | Press this key to access the zero and calibration menus. |
|  | Press this key to reset the MAX HOLD and MIN HOLD measurement. |
|  | Press these keys to enter numeric values in the pop-up fields, for example, the offset values. To complete the entry, use the softkey. |

| Connector | Function |
|---|---|
|  | <p>The power reference is a 1 mW (0 dBm) 50 MHz signal available from a 50 Ω type-N connector. It is used for calibrating an 8480 or E-Series power sensor and meter system. If the meter is configured with Option C03, the connector is fitted to the rear panel. The Green LED beside the connector is lit when the calibrator is turned on.</p> |
|  | <p>The sensor input connectors (N1914A shown, the N1913A has one input). If the meter is configured with Option C02 or C03, the connectors are fitted to the rear panel and the front panel connectors are retained.</p> |
|  | <p>If the meter is configured with Option 201, one USB Type A port is fitted to the front panel (Channel C) and another Type A port (Channel D) to the rear panel.</p> |

The Display Layout

Figure 1-1 shows the display layout when two windows are configured in dual numeric mode.

Other display formats are available by pressing , **Disp Type**.

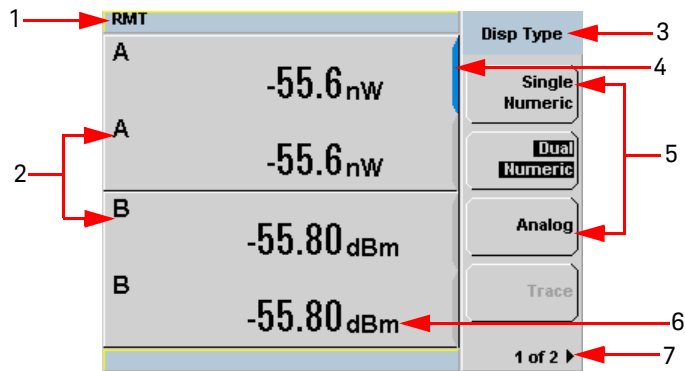

Figure 1-1 Dual numeric display

- 1 The status reporting line displays messages and the control status of the power meter.
For example, the status can be either **RMT** (remote, GPIB, USB or LAN operation) or **LCL** (local, front panel operation). The message fields indicate **ERR** for any error conditions that occur or informing you to **Please Zero** the power sensor.
- 2 The measured channel is shown with a 8480 Series or E-Series power sensor connected.
- 3 This field displays the menu title.

For example, **Channel Setup** or press  and the **Zero/Cal** menu is displayed.

- 4 The blue highlight on the right hand side of the window shows it is the currently selected measurement display line. This measurement line is the Upper Window/Upper Measurement.
- 5 The available softkey labels are displayed in these three fields. Additionally, settings associated with the labeled function are displayed under the label.

Softkey labels that are grayed out cannot be selected.

- 6 This displays the measurement units, either dBm or Watts (W).
- 7 This displays the number of pages in the current menu. For example, **1 of 2** indicates that there are two pages in the menu and the first page is currently displayed. Pressing the softkey displays the next page, indicated by **2 of 2** (press the softkey to display the previous menu page).

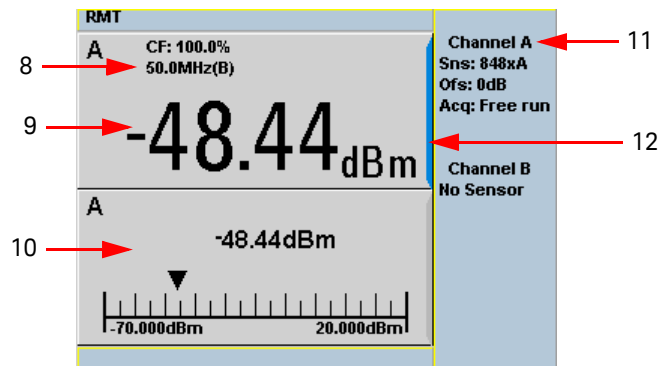





Figure 1-2 Single numeric and analog display

Figure 1-2 shows the default display mode of two measurement windows.

- 8 The channel measurement frequency.
- 9 The upper window is configured to show a single numeric display.
- 10 The lower window is configured to show an analog meter which displays the measurement result and the meter scaling.
- 11 This displays the connected sensor, the offset value, and the acquisition mode on the channel. On dual channel models, it shows for both channels.
- 12 The blue highlight on the right hand side of the window shows it is the currently selected measurement display line.

Using the , , or  keys, you can change the measurement window selection.

Using the  key on numeric measurement results window, you can choose either two rectangular windows, a single enlarged window, or a full screen display. The display style is applied to the currently selected window or measurement line.

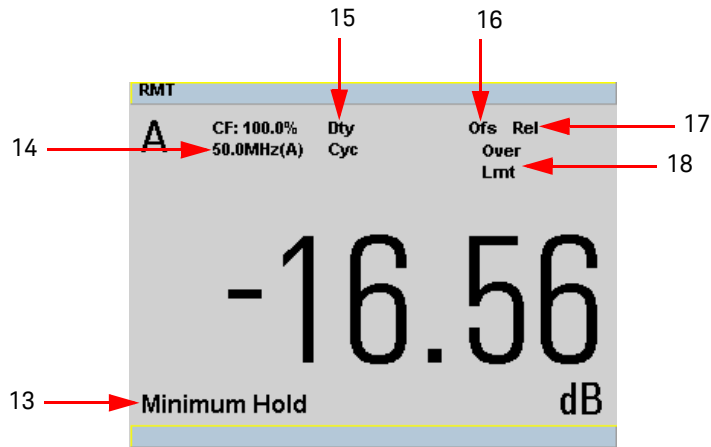

Figure 1-3 Full screen numeric display

Figure 1-3 shows a single numeric full screen displaying a relative result.

- 13** This field displays **Minimum Hold** if range hold is set to minimum.
- 14** The information in this field is displayed on two lines and depends on the sensor type, sensor calibration table, frequency dependent offset table currently selected, and the measurement frequency.
- 15** This field displays **Dty Cyc** if a duty cycle is set.
- 16** This field displays **Ofs** if an offset is set.
- 17** This field displays **Rel** if relative mode is on.
- 18** This field indicates the measurement result is beyond the configured upper or lower limit. If the measurement is within the limits this field is empty. If the measurement result is less than the minimum limit set, **Undr Lmt** is displayed. If the measurement result is more than the maximum limit set, **Over Lmt** is displayed.

Window Symbols and Pop-ups

There are several different graphic symbols and pop-up windows that can occur on the power meter display. These can occur for a variety of reasons, for example:

- An error or warning occurs
- You are required to wait while the power meter carries out a procedure
- You are required to select an entry from a list
- You are required to enter a numeric value

There are three different colors used to signify the pop-up status:

- Green - used to allow data entry
- Orange - used to display information
- Red - used to display an error

Warning Symbol Pop-up

The warning symbol is displayed either in a pop-up window or directly in the measurement window when such an event occurs. A pop-up window is displayed for approximately two seconds. The text in the pop-up window gives details of the warning type, for example, to indicate that a power sensor has insufficient bandwidth or a previous entered frequency value in a table. Depending on the severity of the warning, the pop-up may be displayed in orange or red.



Wait Symbol Pop-up

The wait symbol is displayed when the power meter is carrying out a procedure and no action is required from you. The symbol appears in a pop-up window. It may appear, for example, during a calibration.



Confirm Symbol Pop-up

This type of pop-up window is displayed when you are required to press **Confirm** to verify your previous selection. For example, prior to a **Save** being carried out.

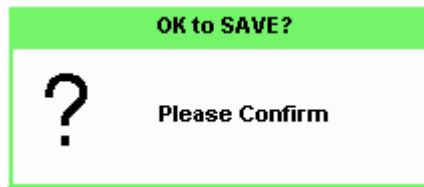

Numeric Entry Pop-up

This type of pop-up window is displayed when you need to modify numeric data. The numeric keys allow you to enter the value.

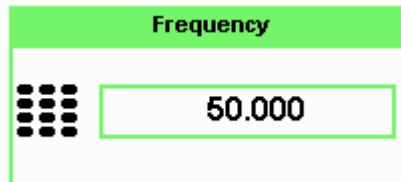

Text Entry Pop-up

This type of pop-up window is displayed when you need to modify alphanumeric data such as table names. The up/down arrow keys increment and decrement the alphanumeric digit that the cursor is currently positioned. The left/right arrow keys move the cursor to another alphanumeric digit.

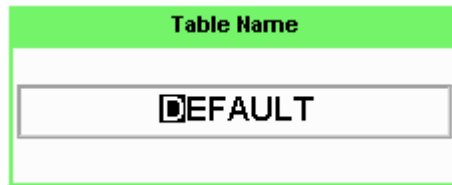

List Pop-up

This pop-up window is displayed when you are required to select an entry from a list. Use the up/down arrow keys to highlight your choice. Press select to complete the entry.

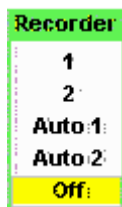

Rear Panel Connections

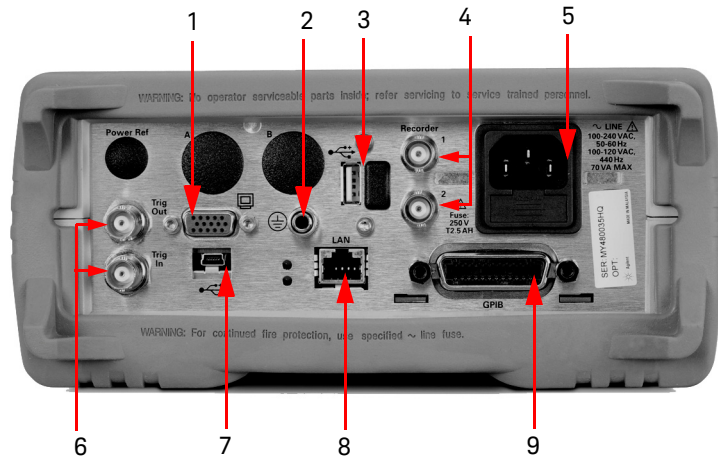

| No. | Connections |
|-----|--|
| 1 | VGA Output (Option 201) |
| 2 | Ground Connector |
| 3 | USB Type A port |
| 4 | Recorder 1/2 Recorder output (two outputs are fitted to dual channel meters) connections are made via BNC connectors. This output produces a DC voltage that corresponds to the power level of the channel input. |
| 5 | AC Inlet This power meter has an auto configuring power supply. This allows it to operate over a range of voltages without manually being set to a certain voltage. |
| 6 | Trig In/Trig Out Trigger input and output connections are made via BNC connectors. |
| 7 | USB Mini-B port This USB port is used only for remote interface connection. |
| 8 | LAN |
| 9 | GPIB This connector allows the power meter to be controlled remotely using the General Purpose Interface Bus. |

Using the Instrument Web Interface

You can communicate with the N1913/1914A EPM Series power meters using the Web interface.

The instrument Web interface can be accessed from Keysight Connection Expert as shown in [Figure 1-4](#).

NOTE

Alternatively, the instrument Web interface can also be accessed directly from a Web browser by entering the instrument's IP address or hostname in the browser's 'address' window.

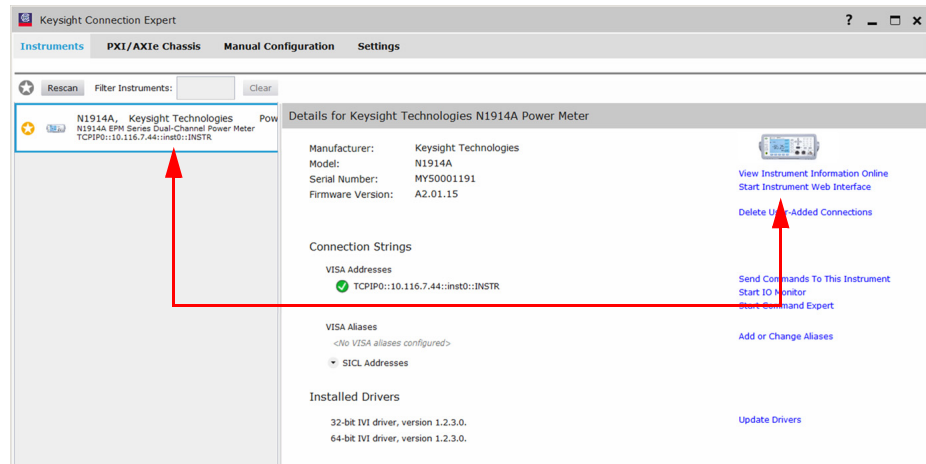

Figure 1-4 Accessing the instrument Web interface

An example of the instrument Web interface (Welcome Page) is shown in [Figure 1-5](#).

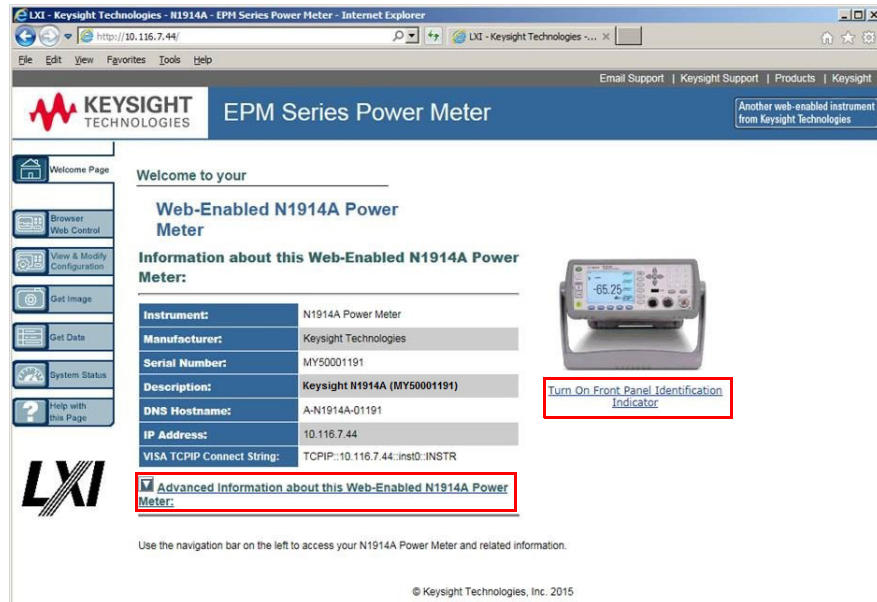

Figure 1-5 N1914A EPM Series power meter Web interface (Welcome Page)

You can control the instrument via GPIB, LAN, and USB connection. The connection parameters can be found on the Welcome Page. For example, SCPI TCPIP socket port (5025), SCPI Telnet port (5024), VISA TCPIP Connect String, VISA USB Connect String, and GPIB address are shown. Click **Advanced Information...** to display more information about the instrument.

NOTE

- The instrument has an embedded Web server, which is listening on port 80 to serve Web pages.
- The Web pages can be browsed using Web browser such as Internet Explorer and Mozilla Firefox.

Instrument on the network can be physically identified from the blinking message on front panel screen by clicking **Turn On Front Panel Identification Indicator** on the Welcome Page.

When the front panel identification indicator is turned on, a blinking “IDENTIFY” message is displayed on the screen of the front panel. See [Figure 1-6](#). The “IDENTIFY” message will blink to identify the instrument until you click **Turn Off Front Panel Identification Indicator**.

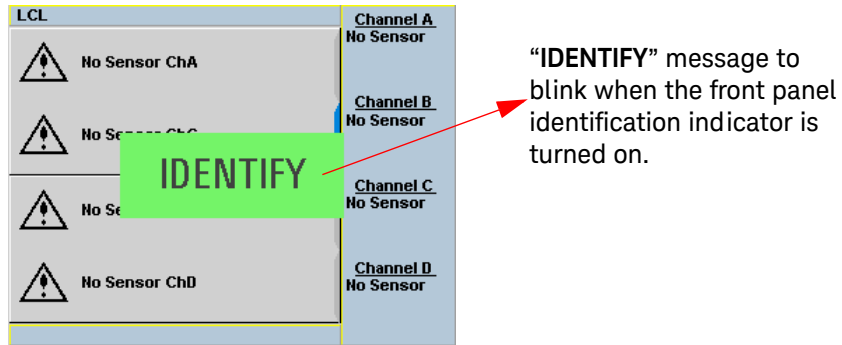

Figure 1-6 Message to identify the instrument

When the instrument is configured to LAN, the **Lan Status** on **Remote Interfaces** screen will show the LAN error condition and status of the LAN configuration connection. There are six types of **Lan Status** messages that may occur. See [Figure 1-1](#). See also [Figure 1-7](#) for the example of **Lan Status** message.

Table 1-1 Type of **Lan Status** message

| Type of message | Description |
|---|--|
| Lan: No Fault Status: Initialized | – A valid IP address is successfully obtained using selected LAN configuration and the network state is initialized. |
| Lan: No Fault Status: Running | – A valid IP address is successfully obtained using selected LAN configuration, while network is running. |
| Lan: Fault Status: Initialization failed | – IP conflict occurs, or – IP address failed to be obtained using selected LAN configuration, or – No LAN configuration is selected. |
| Lan: Fault Status: Disconnected | – LAN cable is unplugged. |

| | |
|--|---|
| <p>Lan: - Status: Restarting</p> | <ul style="list-style-type: none"> - Restart the network and try to obtain an IP address using selected LAN configuration. |
| <p>Lan: DHCP Not Available Status: Running</p> | <ul style="list-style-type: none"> - Unable to obtain IP address from DHCP server (if user select DHCP configuration) - IP address obtained from Auto-IP or manual configuration. |

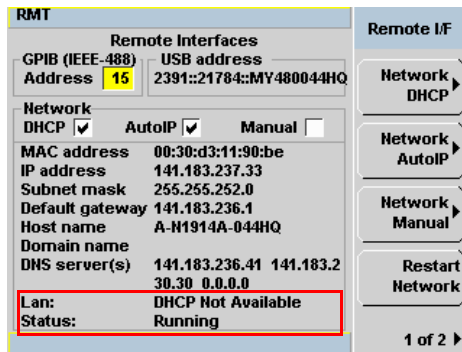

Figure 1-7 Example of Lan Status message

NOTE

For more details on remote interface configuration, refer to *N1913/1914A EPM Series Power Meters Installation Guide*.

Using the Remote Front Panel

The instrument Web interface also provides a virtual front panel interface that can be used to control the power meter remotely.

- 1 On the left of the Welcome Page, select **Browser Web Control**. The remote front panel appears.

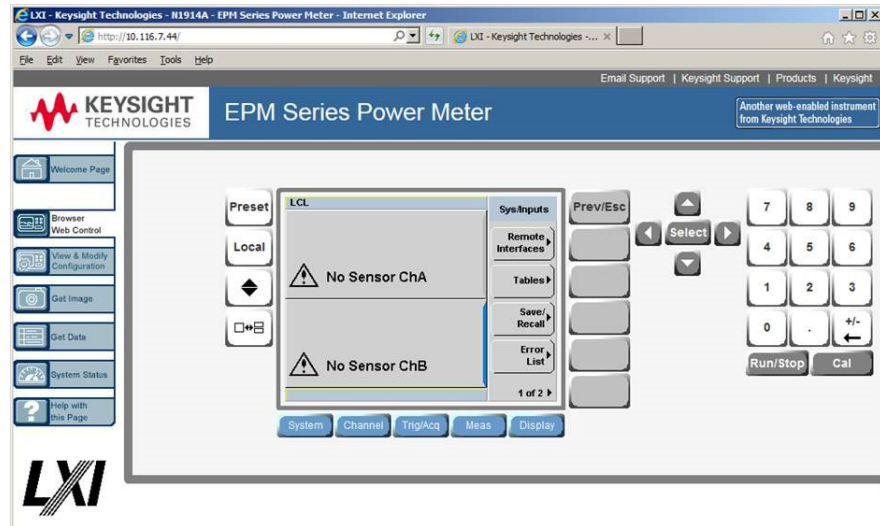

- 2 Click the front panel keys to control the instrument.

NOTE

Java™ must be installed on the controlling PC for remote front panel operation.

Editing the Instrument's LAN Settings

Once communication path to the instrument has been established, the instrument's LAN configuration can be viewed and modified using the Web interface.

On the Welcome Page, click **View and Modify Configuration**. This opens the configuration window shown in [Figure 1-8](#).

The screenshot shows a web browser window displaying the configuration page for an N1914A Power Meter. The page title is "Current Configuration of N1914A Power Meter". A table lists the current LAN settings, with a "Modify Configuration" button above and below the table.

| Parameter | Currently in use |
|---------------------------------|---------------------------------------|
| IP Address: | 10.116.7.44 |
| Subnet Mask: | 255.255.254.0 |
| Default Gateway: | 10.116.6.1 |
| DNS Server(s): | 141.183.230.30 141.183.236.41 0.0.0.0 |
| DNS Hostname: | A-N1914A-01191 |
| NetBIOS: | ON |
| Ethernet Connection Monitoring: | ON |
| Description: | Keysight N1914A (MY50001191) |
| TCP Keep Alive: | ON |
| TCP Keep Alive Time: | 1800 |

Figure 1-8 Viewing LAN configuration settings from the Web interface

To edit parameters shown, click **Modify Configuration**. The **Enter Password** dialog box appears as shown in [Figure 1-9](#).



Figure 1-9 Password security dialog box

Click the **Submit** (accept the default password) and the window opens as shown in [Figure 1-10](#). The default password is “**keysight**”.

NOTE

A LAN reset needs to be performed to ensure that the password is reset to default. See LAN reset procedure as below.

Procedure:

- Press , **Remote Interfaces** to display the **Remote Interfaces** screen.
- Press **1 of 2** softkey to display the second page of the **Remote I/F** menu.
- Press **LAN Reset** softkey to reset the LAN settings to default.

NOTE

When **LAN Reset** softkey is pressed, it will also change the GPIB address to default.

NOTE

You can change the password from the **Configuring your N1914A Power Meter** window as shown in [Figure 1-10](#). Scroll down the **Parameter** column until you locate the **Change Password** parameter.

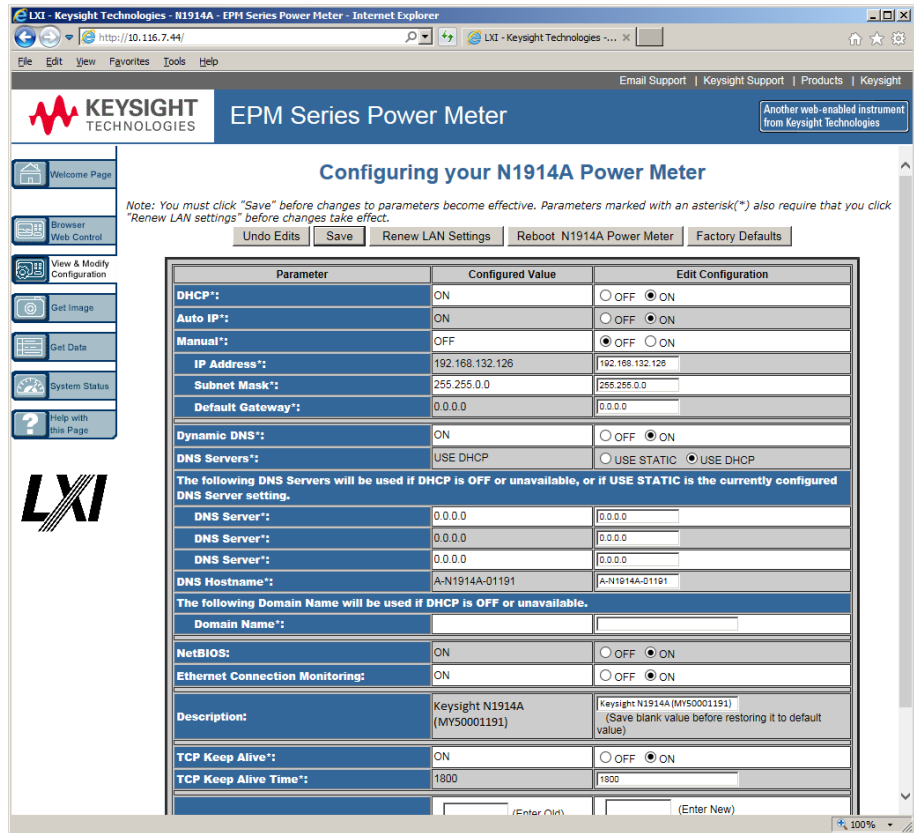
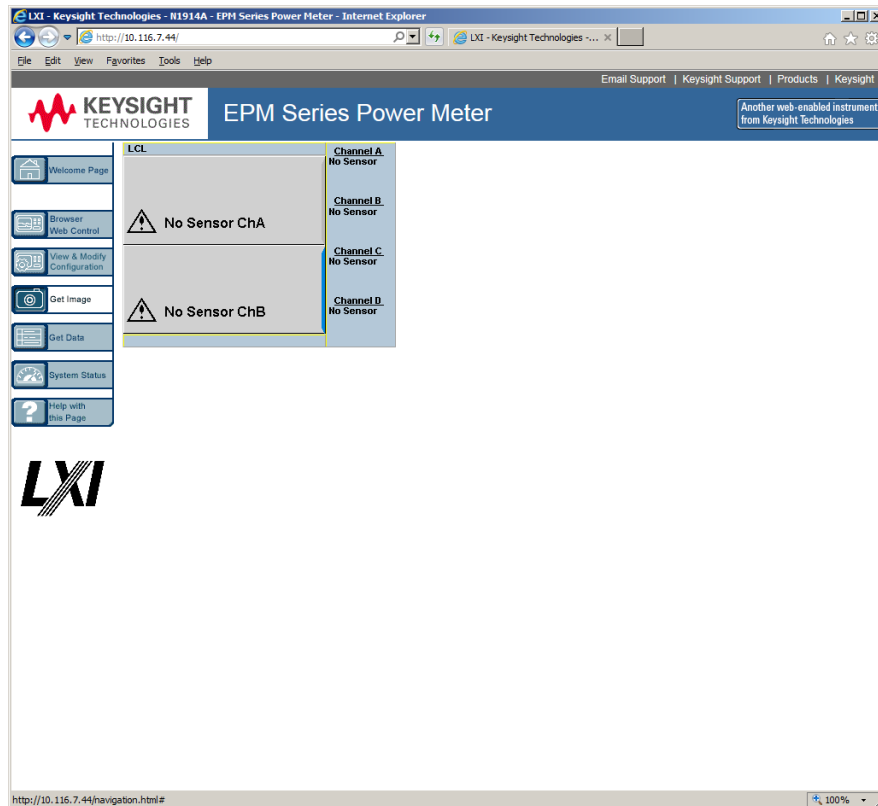

Figure 1-10 Changing the instrument LAN interface configuration

Capturing the Screen Image

To save the instrument's display from the Web interface:

- 1 On the left of the Welcome Page, select **Get Image**. The screen image will be displayed.



- 2 Right-click on the image and select **Save Picture As...**
- 3 Select a storage location for the image file and click **Save**.

The image is captured as a Bitmap (BMP) file, to the default file name display.bmp.

Getting the Instrument Data

The instrument Web interface allows you to transport measurement readings from the instrument to PC applications such as word and spreadsheet applications.

To get the instrument data:

- 1 On the left of the Welcome Page, select **Get Data**. The Get Data Web page will be displayed.

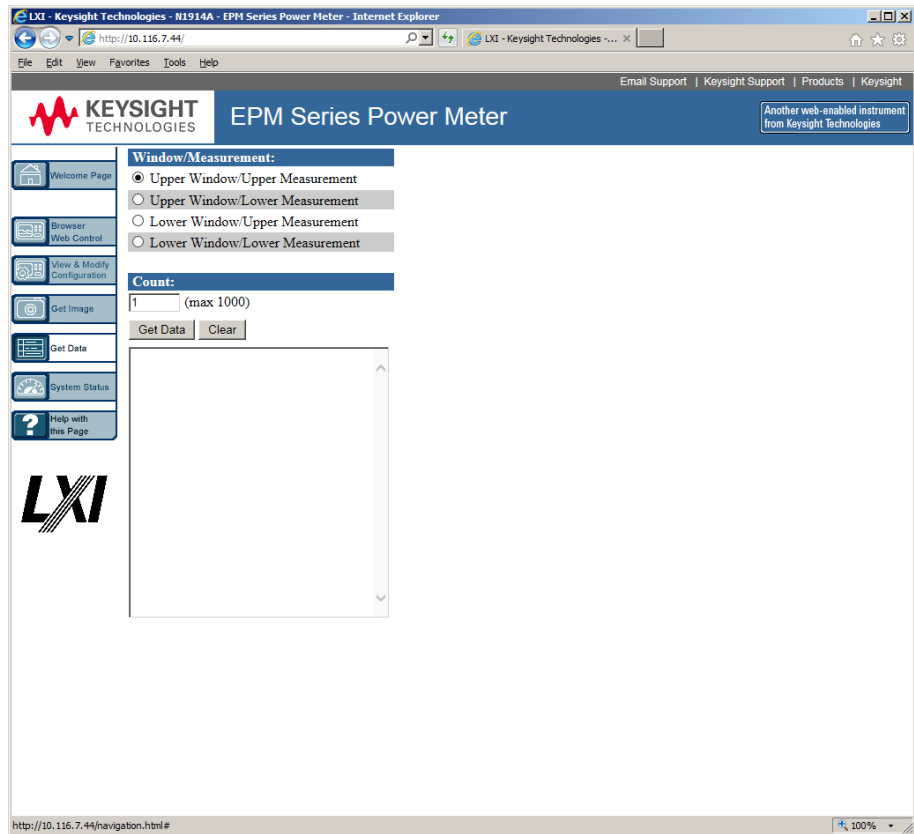

- 2 Select the window/measurement type of the instrument.
- 3 Enter your desired count value (up to 1000 only) of the data and click **Get Data**. The data will be displayed in a text box.
- 4 Copy and paste the data in your intended PC application.

Making Socket Connection

The following steps describe how the power meter can be remotely connected via socket connection:

- 1 Right-click the Keysight IO Libraries  icon on the taskbar and select **Keysight Connection Expert**.

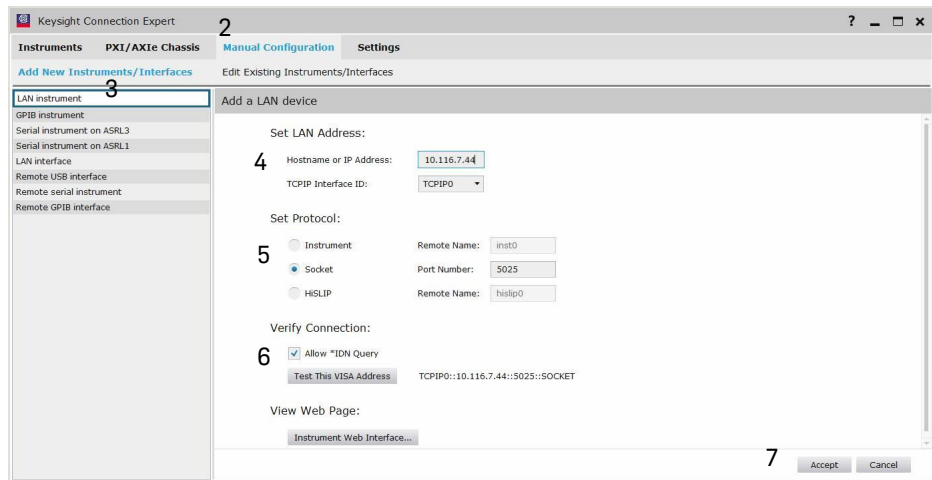

Figure 1-11 Manual Configuration window

- 2 Click **Manual Configuration** on the **Keysight Connection Expert** window.
- 3 Click **LAN instrument**.
- 4 Enter the **Hostname or IP Address** and **TCPIP Interface ID**.
- 5 Select **Socket**.
- 6 Click **Test This VISA Address** to test if the instrument is present.
- 7 Click **Accept**. You will then return to the **Keysight Connection Expert** window. Your power meter is successfully connected via socket connection.

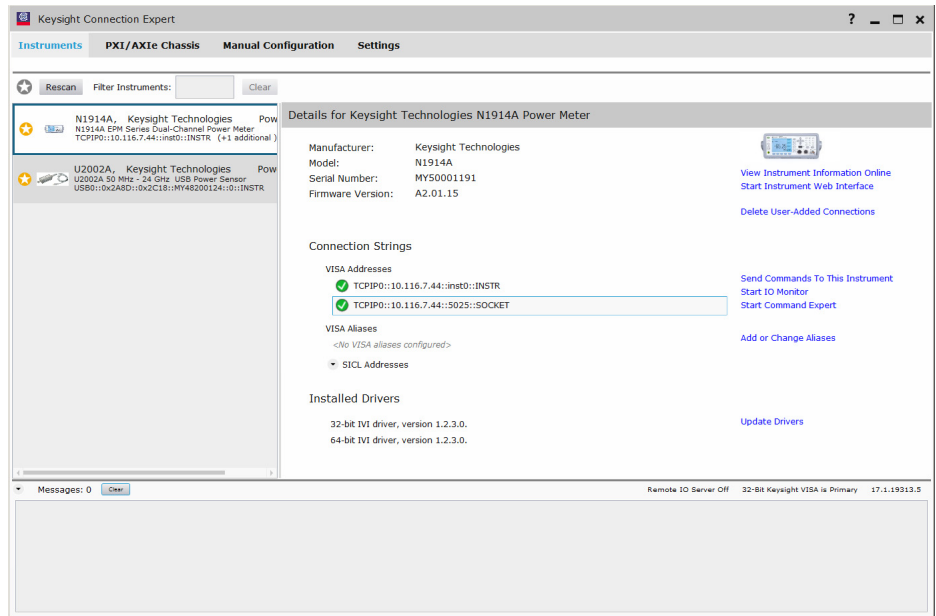

Figure 1-12 Power meter successfully connected via socket connection

Programming Language Selection (Option 200)

The programming language selection is available as an orderable option. For N1913A, you can use SCPI, HP 436A, or HP 437B programming language to program the power meter from the remote interface. For N1914A, you can use either SCPI or HP 438A programming language to program the power meter from the remote interface. The default language is SCPI when the power meter is shipped from the factory.

The power meter complies with the rules and regulations of the 1996.0 version of SCPI (Standard Commands for Programmable Instruments). You can determine the SCPI version with which the power meter is in compliance by sending the **SYSTem:VERSion?** command from the remote interface. You cannot query the SCPI version from the front panel.

The language selection is stored in non-volatile memory and does not change when power has been off or after a remote interface reset.

To select the interface language from the front panel (N1913A),

- 1 Press , **Remote Interfaces, 1 of 2**, and **Command Set**.
- 2 Select the language from **HP 436A**^[1], **HP 437B**^[1], and **SCPI**^[2].

To select the interface language from the front panel (N1914A),

- 1 Press , **Remote Interfaces, 1 of 2**, and **Command Set**.
- 2 Select the language from **HP 438A**^[1], and **SCPI**^[2].

To select the interface language from the remote interface, use the **SYSTem:LANGuage** command.

NOTE

Option 200 can only support 8480 series, N8480 series CFT-option, and E4412/3A power sensors.

[1] HP 436A, HP 437B, and HP 438A language modes are not compatible with LAN or USBTM remote interface.

[2] SCPI is the default factory setting. License is needed for the other languages to be available.

THIS PAGE HAS BEEN INTENTIONALLY LEFT BLANK.

2 General Power Meter Functions

| | |
|--|-----|
| Setting the Units of Measurement | 56 |
| Setting the Measurement Frequency | 57 |
| Setting the Resolution | 58 |
| Making Relative Measurements | 59 |
| Setting Offsets | 61 |
| Setting Measurement Averaging | 73 |
| Step Detection | 75 |
| Measuring Pulsed Signals | 76 |
| Setting External Trigger for Average Power Measurement | 79 |
| Setting Measurement Limits | 87 |
| Single Function Measurement | 92 |
| Combined Measurement | 93 |
| Max Hold/Min Hold | 94 |
| Recorder Output | 97 |
| Saving and Recalling Power Meter States | 100 |
| Zeroing and Calibrating the Power Meter | 102 |
| Adapter Test Procedure | 109 |
| Secure Blank | 113 |
| Backlight Intensity Control | 118 |
| Memory Erase/Secure Erase | 119 |
| VGA Output (Optional) | 122 |
| Warm Start | 123 |
| Battery Information (Optional) | 124 |
| Setting the Cable Short/Long | 130 |

This chapter describes the general operation of the N1913/1914A EPM Series power meters.

Setting the Units of Measurement

The **Units** menu is used to select the measurement units for the currently selected window. These can either be logarithmic (dBm or dB) or linear (Watt or %) units.

Presetting () the power meter sets the measurement units to dBm (logarithmic units). [Table 2-1](#) and [Table 2-2](#) show units that are applicable to each measurement mode.

Press , **Units**. Select the unit of measurement from **dBm**, **W**, **dB**, and **%**. Softkeys which cannot be selected in your particular mode of operation are grayed out.

NOTE

When the measurement unit is set to Watt (W), it is possible that negative power results are displayed when measuring low power levels.

Table 2-1 Measurement units - Single channel meters

| Measurement Mode | Relative Mode Off | Relative Mode On |
|------------------|-------------------|------------------|
| Log | dBm | dB |
| Linear | Watt | % |

Table 2-2 Measurement units - Dual channel meters





| Measurement Mode | | Relative Mode Off | Relative Mode On |
|------------------|--------|-------------------|------------------|
| Ratio | Log | dB | dB |
| | Linear | % | % |
| Difference | Log | dBm | dB |
| | Linear | Watt | % |

Setting the Measurement Frequency

Entering the frequency of the RF signal you are measuring optimizes the accuracy and minimizes measurement uncertainty, especially when making comparative measurements between signals.

Procedure

Set the measurement frequency as follows:

- 1 Press . On dual channel meters select the required channel.
- 2 Use the  and  keys to highlight the **Frequency** value field and press  to display the **Frequency** pop-up. Use the numeric keypad to enter the required value in the **Frequency** pop-up window.

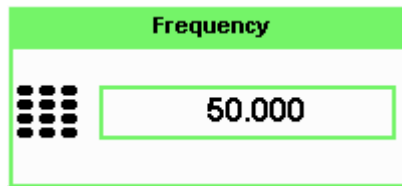



Figure 2-1 Frequency pop-up

- 3 Confirm your choice by pressing **MHz** or **GHz**.
- 4 Press  key to close the **Channel Setup** screen.

Setting the Resolution

The resolution of each of the power meter's numeric type windows can be set to four different levels (1, 2, 3 or 4).

These four levels represent:

- 1, 0.1, 0.01, 0.001 dB respectively if the measurement suffix is dBm or dB.
- 1, 2, 3 or 4 significant digits respectively if the measurement suffix is W or %.

The default value is 0.01 dB (3 digits).



To set the resolution on the currently selected window:

- 1 Press . The current setting of the resolution is highlighted under the **Resolution** softkey.
- 2 To change this setting, press **Resolution** repeatedly until the required resolution setting is highlighted.

Making Relative Measurements

Relative mode enables comparison of a measurement result to a reference value. The relative reading, or difference, can be displayed in either dB or % terms. When the measurement result is displayed in % a prefix multiplier may be shown.

Procedure

- 1 Press  to display the **Measurement Setup** menu.
Figure 2-2 shows a **Measurement Setup** display and the relative measurement items labeled.
- 2 Select the window you wish to set a reference value on by pressing the **Meas Select** key. The currently selected window/measurement is displayed.
- 3 Use the  and  keys to highlight the **Relative** setting field.

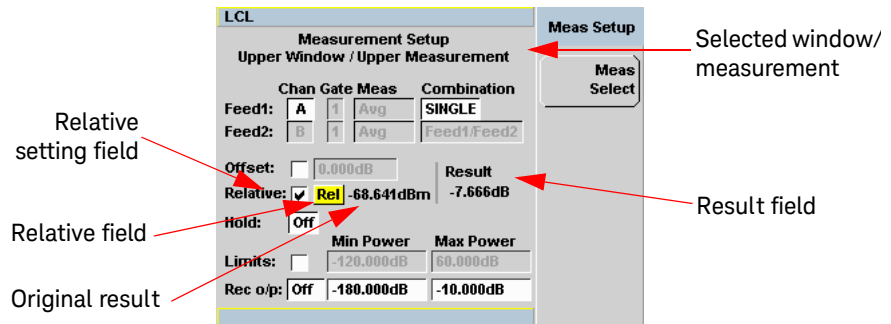





Figure 2-2 Typical relative measurement display

- 4 Press  to check the **Relative** setting field.
- 5 Confirm that the power meter is measuring the signal you want to use as the reference. This is displayed under the **Result** field.
- 6 Press the , , key to highlight the **Rel** field.

- 7 Press  and the original result value will appear on the right hand side of the **Rel** check field.
- 8 The relative value displayed under **Result** field will change as the measured signal varies.

NOTE

If you return the power meter to display the numeric display, a **Rel** symbol will be displayed in the measurement window it is applied to.

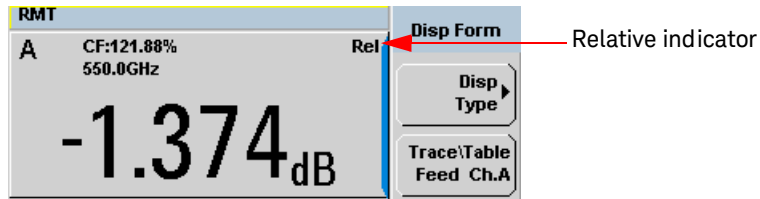

Figure 2-3 Numeric display

NOTE

The **Rel** symbol is not displayed when the associated measurement is displayed in **Dual Numeric** or **Analog** format.

Setting Offsets

The power meter can be configured to compensate for a signal loss or gain in your test setup. The power meter allows you to apply offsets at three different points in the measurement path.

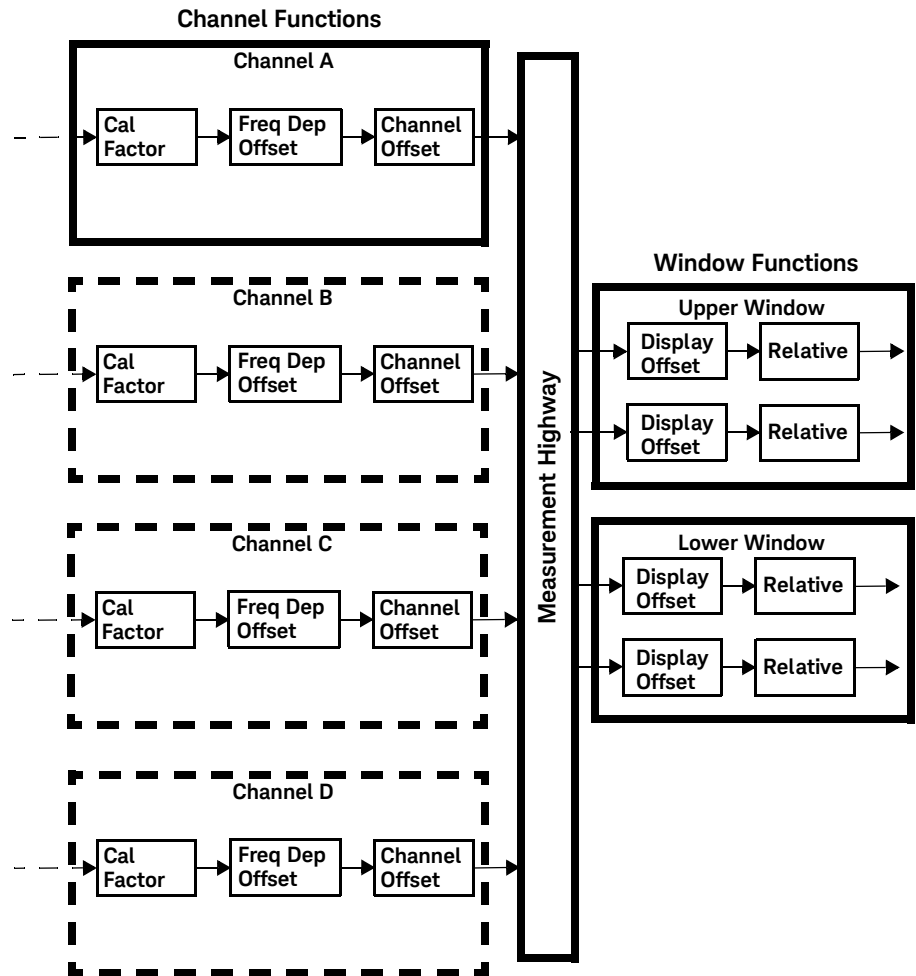

Figure 2-4 Simplified measurement path

Figure 2-4 shows that how you can apply a **Channel Offset** or a **Frequency Dependent Offset** prior to any mathematical functions. These allow you to compensate each channel individually. An overall offset can be applied if required using the **Display Offset**.

Setting Channel Offsets

This gain or loss is applied to the measured power before any mathematical functions, display offsets or relative functions are included.





Offsets are entered in dB and the range is -100 dB to +100 dB.

The equivalent range in % is from 0.0000000001% to 10000000000%.

A positive value compensates for a loss and a negative value compensates for a gain.

Procedure

To enter a channel offset:

- 1 Press  to display the **Channel Setup** screen. Confirm the channel requiring setup is displayed.
- 2 Press **Offsets** to display the **Offsets Setup**.
- 3 Use the  and  keys to highlight the **Offset** setting field.
- 4 Press  to check the **Offset** setting field.

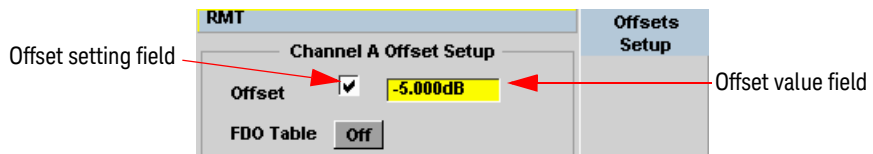





Figure 2-5 Typical channel offset display

- 5 Press  to highlight the **Offset** value field and press  to display the **Offset** pop-up. Use the numeric keypad to enter the required value in the **Offset** pop-up window.

- 6 Confirm your choice by pressing **dB**.
- 7 Press  key to complete the offset entry. If either a channel or a display offset is set, the **Ofs** indicator is displayed.

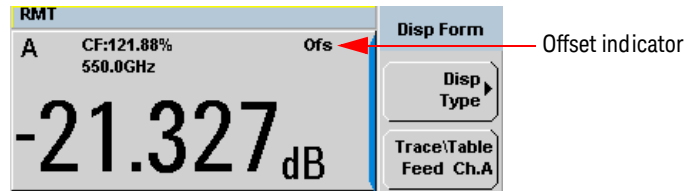

Figure 2-6 Channel offset indicator

NOTE

The **Ofs** symbol is not displayed when the associated measurement is displayed in Dual Numeric or Analog format.





Setting Display Offsets

This gain or loss is applied to the measured power after any channel offsets or mathematical functions have been included.

Offsets are entered in dB and the range of values is -100 dB to $+100$ dB. A positive value compensates for a loss, and a negative value compensates for a gain.

Procedure

Enter a display offset on the currently selected window:

- 1 Press  to display the **Measurement Setup** screen.
- 2 Select the window you wish to set the offset value on by pressing the **Meas Select** key. The currently selected window/measurement is displayed.
- 3 Use the  and  keys to highlight the **Offset** setting field.
- 4 Press  to check the **Offset** setting field.

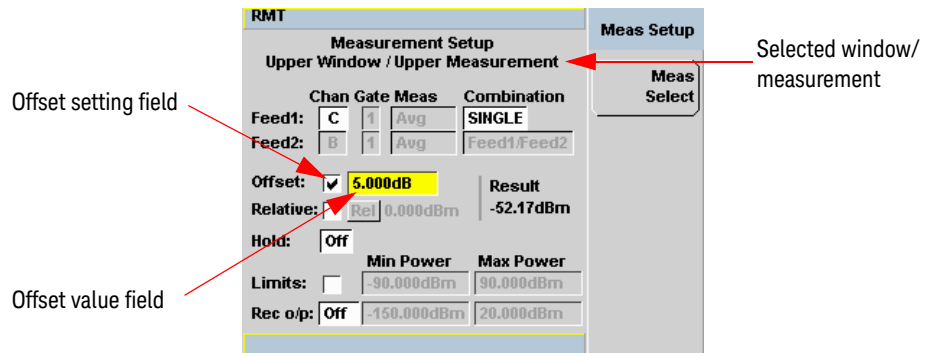





Figure 2-7 Typical display offset display

- 5 Press  to highlight the **Offset** value field and press  to display the **Display Offset** pop-up. Use the numeric keypad to enter the required value in the **Offset** pop-up window.
- 6 Confirm your choice by pressing **dB**. Press  key to complete the offset entry.

NOTE

The **Ofs** indicator is displayed if Display Offset is selected.

Setting Frequency Dependent Offsets

Frequency dependent offset tables provide a quick and convenient method of compensating for frequency related changes in the response of your test system. Note that when selected, frequency dependent offset corrections are applied IN ADDITION to any correction for sensor frequency response.

The power meter is capable of storing 10 frequency dependent offset tables with a maximum of 80 frequency points each.

To use frequency dependent offset tables:

- 1 Select the table to be applied to a channel. Refer to “[Setting Frequency Dependent Offsets](#)” on page 65 for further information. If you require to edit the table refer to “[Editing Frequency Dependent Offset Tables](#)” on page 68 for further information.
- 2 If an 8480 Series, N8480 Series, an E-Series, or an U2000 Series sensor is used, zero and calibrate the power sensor. The reference calibration factor used during the calibration is automatically set by the power meter from the sensor calibration table (if selected).
- 3 Specify the frequency of the signal you want to measure. The calibration factor/offset is automatically set by the power meter from the sensor calibration table (if selected) and the frequency dependent offset table. Refer to “[Procedure](#)” on page 66 for further information.
- 4 Make the measurement.

Selecting a Frequency Dependent Offset Table

You can select a frequency dependent offset table from the  key menu followed by **Tables**, **Meter**, and **Freq. Dep. Offset** for Channel A or Channel B.

For Channel C, you can select the frequency dependent offset table from the



key menu followed by **Tables**, **Sensor ChC**, and **Freq. Dep. Offset**.





For Channel D, you can select the frequency dependent offset table from the



key menu followed by **Tables**, **Sensor ChD**, and **Freq. Dep. Offset**.

The State column indicates if any frequency dependent offset tables are currently selected. The **Offset Tables** screen is shown in [Figure 2-8](#).

NOTE





You can also view which FDO table is being used by pressing the , **Offsets** and use the  and  keys to highlight the **FDO Table** setting field and press  to display the table.

Procedure

Select an offset table as follows:

1 Press, either:



a , **Tables**, **Freq. Dep. Offset**.

b , **Offsets** and use the  and  keys to highlight the **FDO Table** setting field and press  to display the table.

| RMT | | | Offset Tbls |
|------------|-------|-----|--|
| Tbl Name | State | Pts | |
| A CUSTOM_A | off | 1 | Edit Table A Table Off On B Table Off On |
| B CUSTOM_B | off | 0 | |
| C CUSTOM_C | off | 0 | |
| D CUSTOM_D | off | 0 | |
| E CUSTOM_E | off | 0 | |
| F CUSTOM_F | off | 0 | |
| G CUSTOM_G | off | 0 | |
| H CUSTOM_H | off | 0 | |
| I CUSTOM_I | off | 0 | |
| J CUSTOM_J | off | 0 | |



1 of 1

Figure 2-8 Frequency dependent offset tables display

2 Use the  and  keys to highlight one of the 10 table titles and press **Table** (**A Table** or **B Table** for dual channel) to highlight **On**.

NOTE

When no data is contained in the highlighted table, the **Table** key is disabled (grayed out).

- 3 Press  to complete the selection of the offset table.
- 4 Press  again to display the measurement screen. **Figure 2-9** shows which offset table is selected.

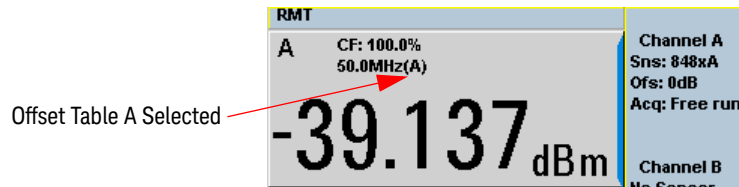





Figure 2-9 Frequency dependent offset indicator

- 5 To change the frequency, press  and use the  and  keys to highlight the **Frequency** field.
- 6 Press  to display the **Frequency** pop-up window. Use the numeric keypad to enter the required value in the **Frequency** pop-up window.
- 7 To confirm your choice, press the appropriate unit softkey.
- 8 Connect the power sensor to the signal to be measured.
- 9 The measurement result, including offset, is now displayed.

NOTE

If the measurement frequency does not correspond directly to a frequency in the sensor calibration table (if selected) and the frequency dependent offset table being used, the power meter calculates the calibration factor and offset using linear interpolation. If you enter a frequency outside the frequency range defined in the sensor calibration table or the frequency dependent offset table, the power meter uses the highest or lowest frequency point in the appropriate table to set the calibration factor and offset.

Editing Frequency Dependent Offset Tables

There are ten frequency dependent offset tables named **CUSTOM_A** through **CUSTOM_J**. They are empty of any data when the power meter is shipped from the factory.

You cannot delete any of the 10 existing frequency dependent offset tables or create any additional tables. However, you can enter values into the 10 existing tables. Each frequency dependent offset table can contain a maximum of 80 frequency points.

To view the frequency dependent offset tables currently stored in the power

meter, press , **Tables**, **Freq. Dep. Offset**. The **Frequency Dependent Offset Tables** screen is displayed as shown in [Figure 2-8](#).

Editing frequency dependent offset tables requires the following steps:



- 1 Identify and select the table you want to edit
- 2 Rename the table
- 3 Enter the frequency and offset pairs
- 4 Save the table

Procedure

First, select the table you want to edit as follows:

NOTE

A frequency in the range of 0.001 MHz to 1000.0 GHz can be entered. A calibration factor in the range of 0.0000000001 to 10000000000 can be entered.

- 1 Press , **Tables**, **Freq. Dep. Offset** to display the **Offset Tbls** screen.
- 2 Choose the table you want to edit using the  and  keys. Press **Edit Table** to display the **Edit Offset** screen as shown in [Figure 2-10](#).

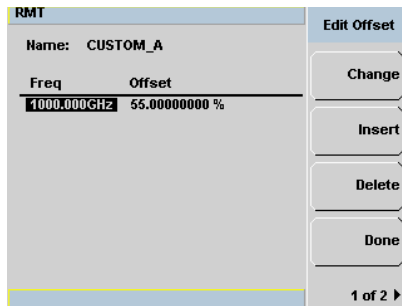







Figure 2-10 “Edit Offset” display with data added

- 3 Highlight the table title using the  and  keys. Press **Change** and use the , ,  and  keys to select and change the characters in the **Table Name** pop-up to create the name you want to use.

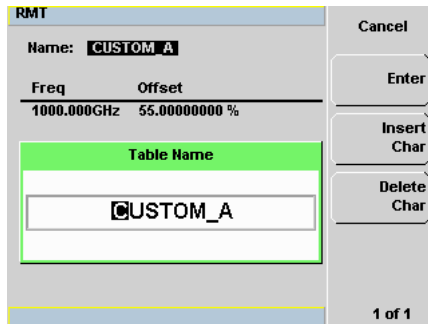

Figure 2-11 Edit table title pop-up

- Pressing **Insert Char** adds a new character to the right of the selected character.
 - Pressing **Delete Char** removes the selected character.
- 4 Press **Enter** to complete the entry.

NOTE

The following rules apply to naming sensor calibration tables:

- The name must consist of no more than 12 characters.
- All characters must be upper or lower case alphabetic characters, or numeric (0-9), or an underscore (_).
- No other characters are allowed.
- No spaces are allowed in the name.

Enter (or edit) the frequency and offset pairs as follows:

- 1 Press **Insert** to add a new frequency value (or press **Change** to edit). Use the numeric keypad to enter the required value in the **Frequency** pop-up window. Complete the entry by pressing the **GHz**, **MHz** keys.
- 2 Enter the new offset value (or press **Change** to edit). Use the numeric keypad to enter the required value in the Offset pop-up window. Complete the entry by pressing the **%** key.

| RMT | | Offset Unit |
|-----------------------|---------------|-------------|
| Name: CUSTOM A | | |
| Freq | Offset | |
| 50.000MHz | 50.00000000 % | dB |
| 58.000GHz | 45.00000000 % | % |
| | | 1 of 1 |

Figure 2-12 Changing offset unit

- 3 Continue adding/editing values until you have entered all the data you require.
- 4 When you have finished editing the table press **Done** to save the table.

NOTE

If you measure a signal with a frequency outside the frequency range defined in the frequency dependent offset table, the power meter uses the highest or lowest frequency point in the frequency dependent offset table to calculate the offset

Selectable Frequency Dependent Offset Unit (dB or %)

The offset in dB range is from -100 dB to +100 dB.

The equivalent range in % is from 0.0000000001% to 10000000000%.

Once the offset unit is selected, it will be applied to all the offsets in the selected table and also to the remaining nine tables.

To change the offset unit to dB, press **1 of 2**, **Offset Unit**, and **dB**.

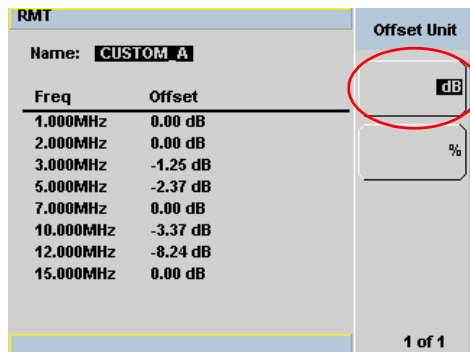

To change the offset unit to %, press **1 of 2**, **Offset Unit**, and **%**.

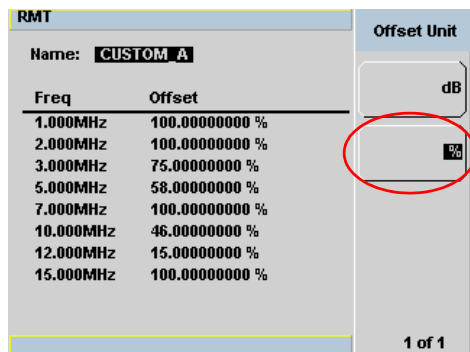

If the selected offset unit is %, the display of the offset will be in engineering unit only if the percentage value is less than 0.01% or more than 999%. The format of the display in engineering unit for an offset greater than 999% will be shown as follows,

xxx. yyyyyyyyyy e+z

- There is a maximum of three numbers before the decimal point indicated by **x**.
- **y** is optional if there are non-zero numbers after the decimal point.

For example,

- 123478202 will be displayed as 123.478202 e+6
- 10000 will be displayed as 100 e+2.

The format of the display in engineering unit for an offset less than 0.01% will be as follows,

x. yyyyyyyyyy e-z

- The first leading non-zero number, **x**, is placed before the decimal point.
- **y** is optional if there are non-zero numbers after the decimal point.

For example,

- 0.009876 will be displayed as 9.876 e-3
- 0.0001 will be displayed as 1e-4.

| RMT | | Edit Offset |
|-----------------------|---------------------|-------------|
| Name: CUSTOM A | | |
| Freq | Offset | Change |
| 1.000MHz | 1234.78202000 e+5% | |
| 2.000MHz | 100.00000000 % | Insert |
| 3.000MHz | 75.00000000 % | |
| 5.000MHz | 1000.00000000 e+2 % | Delete |
| 7.000MHz | 100.00000000 % | |
| 10.000MHz | 1.0000000 e-5 % | Done |
| 12.000MHz | 15.00000000 % | |
| 15.000MHz | 100.00000000 % | |
| | | 1 of 2 ▶ |

Figure 2-13 Offset display in engineering unit (when the selected unit is %)

Setting Measurement Averaging

The power meter uses a digital filter to average power readings. The number of readings averaged can range from 1 to 1024. This filter is used to reduce noise, obtain the desired resolution and to reduce the jitter in the measurement results. Increasing the value of the measurement average reduces measurement noise. However, the measurement time is increased. You can manually select the measurement average or you can set the power meter to auto measurement average mode. The default is **AUTO**.

When the auto measurement average mode is enabled, the power meter automatically sets the number of readings averaged together to satisfy the filtering requirements for most power measurements. The number of readings averaged together depends on the resolution setting and the power level currently being measured.

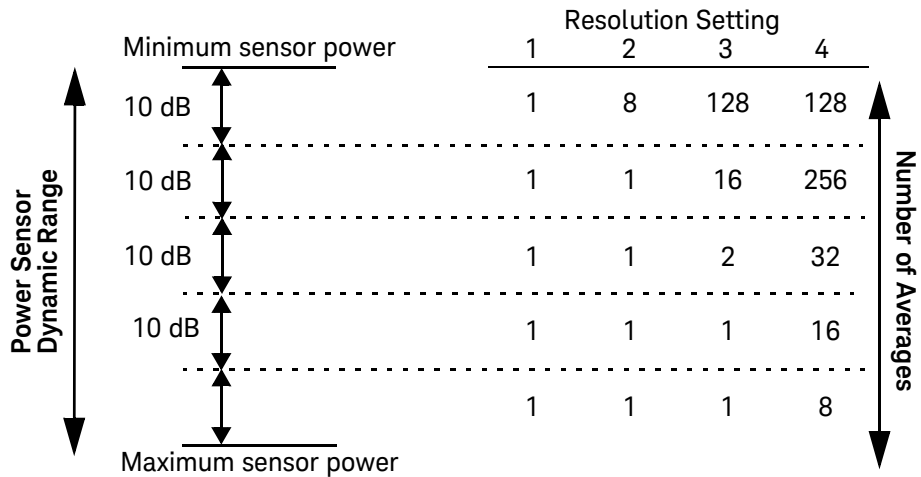

Figure 2-14 Typical averaged readings

Figure 2-14 shows the typical number of averages for each range and resolution when the power meter is in auto filter mode and is set to normal speed mode. N1913/1914A EPM Series power meters recognize different sensor types when they are connected, and configure suitable averaging automatically.









Resolution is a measurement display function and not a channel function. In the case where a channel is set up in both the upper and lower window and the resolution settings are different, the highest resolution setting is taken to calculate the averaging number.

These four resolution levels represent:

- 1, 0.1, 0.01, 0.001 dB respectively if the measurement suffix is dBm or dB.
- 1, 2, 3 or 4 significant digits respectively if the measurement suffix is Ω or %.

Procedure

Set measurement averaging as follows:

- 1 Press . On dual channel meters select the required channel. The current setting is shown in the Meas Avg field (**AUTO**, **MAN**, or **OFF**) on the **Channel Setup** screen. The default is **AUTO**.
- 2 Use the  and  keys to select the Filter setting field.
- 3 Press  and use the  and  to step through the available settings. If you have selected **AUTO** or **OFF** proceed at step 7. If you have selected **MAN** proceed as follows.
- 4 Use the  key to select the **Meas Avg:** value field.
- 5 Press  to display the **Meas Avg Count** pop-up.

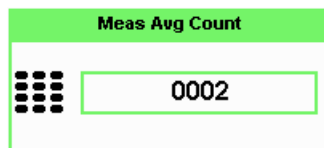



Figure 2-15 Meas Avg Count pop-up





- 6 Use the numeric keys to enter the required value and press **Enter**.
- 7 Press  key to close the **Channel Setup** screen.

Step Detection

To reduce the filter settling time after a significant step in the measured power the filter can be set to re-initialize upon detection of a step increase or decrease in the measured power. Step detection can be set in both manual and automatic measurement average modes.

Procedure

Set step detection as follows:

- 1 Press . On dual channel meters select the required channel.
- 2 Use the  and  keys to select the **Step Detect** setting field.
- 3 Press  to check the step detection to on or off.
- 4 Press  key to close the **Channel Setup** screen.

Measuring Pulsed Signals

The power meter can be used to measure the power of a pulsed signal. The measurement result is a mathematical representation of the pulse power rather than an actual measurement (assumes constant peak power). The power meter measures the average power of the pulsed input signal and then divides the measurement result by the duty cycle value to obtain the pulse power reading. The allowable range of values is 0.001% to 100%. The default value is 1.000%.

If duty cycle is enabled, then **Dty Cyc** is displayed.

NOTE

Pulse measurements are not recommended using Keysight E4412A and E4413A power sensors.

An example of a pulsed signal is shown in [Figure 2-16](#).

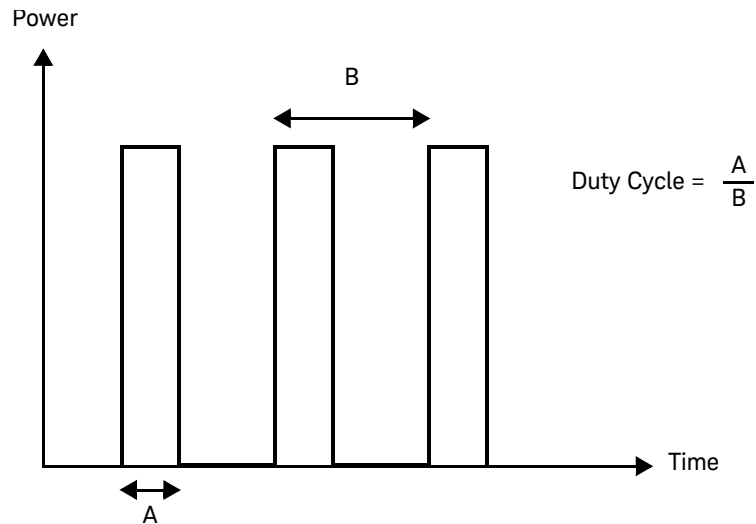





Figure 2-16 Pulsed signal

Procedure

Set duty cycle as follows:

- 1 Press  to display the **Channel Setup** screen. Confirm the channel requiring setup is displayed.
- 2 Press **Offsets** to display the **Offsets Setup**.
- 3 Use the  and  keys to highlight the **Duty Cycle** setting field.
- 4 Press  to check the **Duty Cycle** setting field.

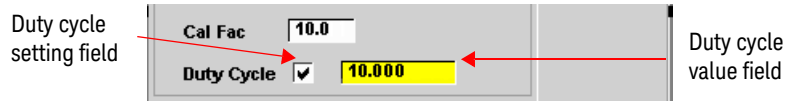





Figure 2-17 Duty cycle setting

- 5 Press  to highlight the **Duty Cycle** value field and press  to display the **Duty Cycle** pop-up. Use the numeric keypad to enter the required value in the **Duty Cycle** pop-up window.
- 6 Confirm your choice by pressing **%**.
- 7 Press  key to complete the duty cycle entry. The **Dty Cyc** indicator is displayed as shown in [Figure 2-18](#).

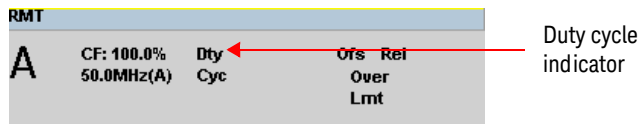

Figure 2-18 Duty cycle indicator

NOTE

Pulse power averages out any aberrations in the pulse such as overshooting or ringing. For this reason, it is called pulse power and not peak power or peak pulse power.

In order to ensure accurate pulse power readings, the input signal must be pulsed with a rectangular pulse. Other pulse shapes (such as triangle, chirp, or Gaussian) will cause erroneous results.

The pulse power on/off ratio must be much greater than the duty cycle ratio.

Setting External Trigger for Average Power Measurement

There are two modes featured in triggered average power measurement

- Power sweep mode
- Frequency sweep mode

These modes are used to eliminate the need for lengthy test routines, while increasing measurement throughput by reducing overhead of communication with the controller. The sweep feature allows you to make power measurement by quickly stepping through a series of frequencies or power levels. Configuration shown in [Figure 2-19](#) illustrates the triggering connection required to synchronize power meter measurement to the power source settings.

NOTE

Trigger delay and trigger holdoff are both not applicable when the power meter is set to power sweep mode or frequency sweep mode.

Power Sweep Mode

Power sweep is generally used in power level calibration setup where the frequency is fixed (CW frequency), and the amplitude of the power source signal is swept. This mode can be used to characterize the flatness, linearity or gain compression of a device under test.

NOTE

This feature is only available when 8480 Series, N8480 Series, E-Series E4410, or E-Series E9300 sensor is connected.

Procedures

- 1 Connect sensor to a power source.
- 2 Connect power meter **TRIG OUT** to power source **TRIG IN** using a BNC cable. The same connection is applied for power source **TRIG OUT** to power meter **TRIG IN**.

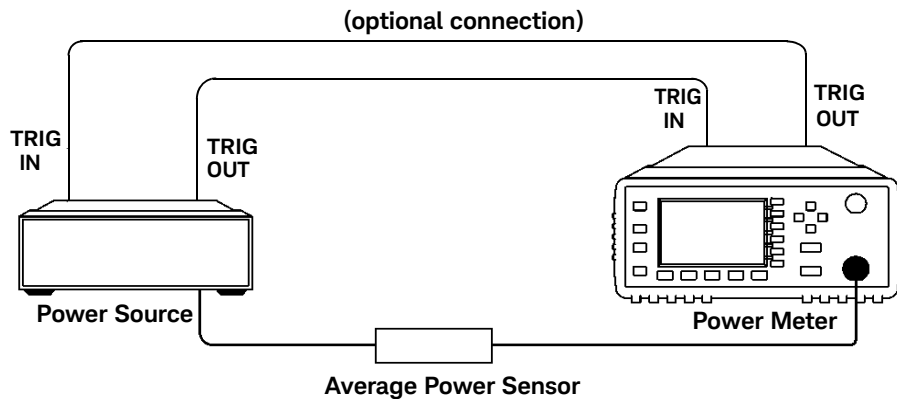

Figure 2-19 TRIG IN and TRIG OUT connection diagram between power meter and power source

- 3 Press . The **Channel Setup** screen displays as below.

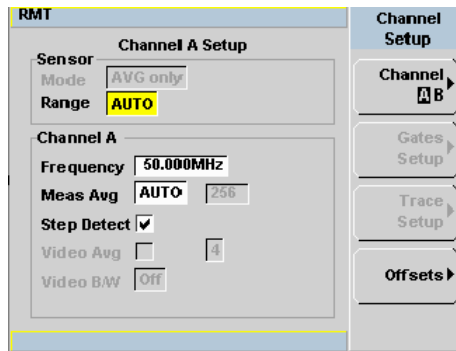







Figure 2-20 Channel Setup display

NOTE

When 8480 Series, N8480 Series, E-Series E4410, E-Series E9300 or U2000 Series sensor is connected, **Sensor Mode** is set to **AVG only** by default.

- 4 Press . The **Trigger** menu is displayed.
- 5 Press **Acqn** softkey to configure the trigger.
- 6 Select either **Sing Trig** or **Cont Trig**.
 - **Sing Trig** is a single shot mode. After triggering, the measurement is halted, and the  symbol is displayed. You can start another measurement by pressing the  key.
 - **Cont Trig** is a continuous trigger mode. The symbol  or  is displayed.
- 7 Press **Settings** to configure the remaining trigger parameters. The trigger **Settings** menu consists of two pages. [Figure 2-21](#) shows page 1 and [Figure 2-22](#) shows page 2.

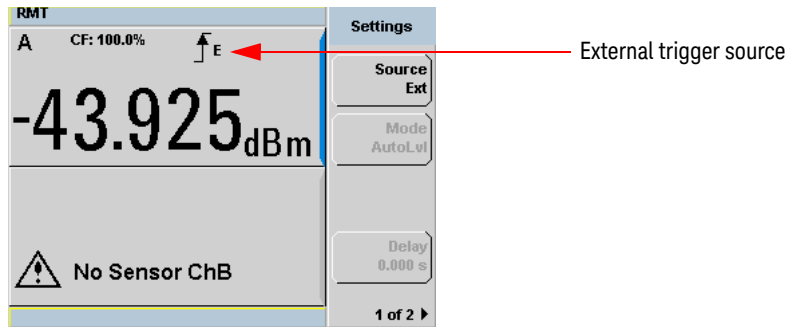

Figure 2-21 Trigger setting menu 1 of 2

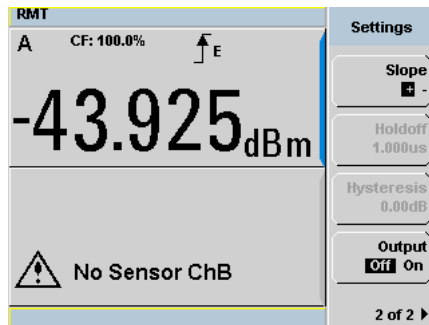

Figure 2-22 Trigger setting menu 2 of 2

- 8 Press **Source** and **Ext** will be automatically enabled.
- 9 Press **1 of 2**, **Output** and **On** to allow a TTL level high to be produced at the rear panel **TRIG OUT** BNC port when the meter is triggered upon a completed measurement.
- 10 Press **Slope** and select **+** or **-** to set the trigger edge.
- 11 Set the trigger buffer size by sending `SENSE:BUFFEr:COUNT <buffer_size>` command to meter using remote interface.

NOTE



Refer to the *N1913/1914A EPM Series Power Meters Programming Guide* for the commands usage details.

Example of command set:

```
BUFF:COUN 100
```

NOTE

The power meter can be remotely controlled by LAN, USB and GPIB (IEEE488) programming interfaces. Refer to *N1913/1914A EPM Series Power Meters Installation Guide* for details.

- 12 Press  or  to setup measurement setting such as measurement averaging, measurement frequency, offsets, duty cycle and so forth. Refer to “General Power Meter Functions” on page 55 for the setup procedures.
- 13 Send ***OPC** (OPeration Complete) command to meter to set the operation complete bit in the Standard Event Status register when all pending device operations are completed.
- 14 Set the meter to continuous trigger mode by sending **INITiate:CONTinuous ON** command to meter.
- 15 Configure and set the required power sweep range and step on the power source accordingly.
- 16 Set the power source trigger input and trigger output, then start sweeping.
- 17 Poll the status of the power meter by sending ***ESR?**. ***ESR?** will return a 1 when buffering is completed. Use **FETCh?** to retrieve all the buffered measurement.

Frequency Sweep Mode

Frequency sweep is generally used in a frequency response calibration system where the amplitude is fixed, and the frequency of the power source signal is swept. This mode can be used to determine the frequency response of a device under test.

NOTE

This feature is only available when N8480 Series, E-Series E4410, or E-Series E9300 sensor is connected.



Procedures

- 1 Connect sensor to a power source.
- 2 Connect power meter **TRIG OUT** to power source **TRIG IN** using a BNC cable. The same connection is applied for power source **TRIG OUT** to power meter **TRIG IN**. See [Figure 2-19](#).
- 3 Press . The **Channel Setup** displays as shown in [Figure 2-20](#).

NOTE

When N8480 Series, E-Series E4410, E-Series E9300 or U2000 Series sensor is connected, **Sensor Mode** is set to **AVG only** by default.

- 4 Press . The **Trigger** menu is displayed.
- 5 Press **Acqn** softkey to configure a trigger.
- 6 Select either **Sing Trig** or **Cont Trig**.
- 7 Press **Settings** to configure the remaining trigger parameters. The trigger Settings menu consists of two pages. [Figure 2-21](#) shows page 1 and [Figure 2-22](#) shows page 2.
- 8 Press **Source** and **Ext** will be automatically enabled.
- 9 Press **1 of 2**, **Output** and **On** to allow a TTL level high to be produced at the rear panel **TRIG OUT** BNC port when the meter is triggered upon a completed measurement.

- 10 Press  or  to setup measurement settings such as measurement averaging, measurement frequency, offsets, duty cycle and so forth. Refer to “General Power Meter Functions” on page 55 for the setup procedures.
- 11 Set the frequency range and step by sending the below commands to meter using remote interface.
- SENSE1:FREQUENCY:START <start_frequency><frequency_unit>
 - SENSE1:FREQUENCY:STOP <stop_frequency><frequency_unit>
 - SENSE1:FREQUENCY:STEP <frequency_step_size>

NOTE

Refer to the *EPM Series Power Meters Programming Guide* for the commands usage details.

Example of commands set:

FREQ:STAR 10MHz

FREQ:STOP 500MHz

FREQ:STEP 10

NOTE

The power meter can be remotely controlled by LAN, USB and GPIB (IEEE488) programming interfaces. Refer to *N1913/1914A EPM Series Power Meters Installation Guide* for details.

- 12 Send *OPC (OPeration Complete) command to meter; to set the operation complete bit in the Standard Event Status register when all pending device operations are completed.
- 13 Set the meter to continuous trigger cycles by sending **INITiate:CONTinuous ON** command to meter.
- 14 Configure and set the required power sweep range and step of the power source.
- 15 Set the power source trigger input and trigger output.
- 16 Set the power source to sweep.

17 Poll the status of the power meter by sending ***ESR?**. ***ESR?** will return a 1 when buffering is completed. Use **FETCh?** to retrieve all the buffered measurement.

NOTE

In both power sweep and frequency sweep mode, the meter **TRIG OUT** to power source **TRIG IN** connection is optional. You may choose to setup the Dwell time in the power source step setting to cater the maximum settling time required by the power meter.

Determine the Right Step to be Set

Number of frequency step can be calculated by using equation below:

$$\text{Step} = (f_{\text{stop}} - f_{\text{start}} + \text{Interval})/\text{Interval}$$

where,

Step = Number of frequency step

f_{start} = Frequency sweep's start point

f_{stop} = Frequency sweep's stop point

Interval = Frequency step size

Example

When $f_{\text{start}} = 1$ GHz and $f_{\text{stop}} = 5$ GHz with given interval of 0.5 GHz, the Step should be set to

$$\begin{aligned} \text{Step} &= (f_{\text{stop}} - f_{\text{start}} + \text{Interval})/\text{Interval} \\ &= (5 \text{ GHz} - 1 \text{ GHz} + 0.5 \text{ GHz})/0.5 \text{ GHz} \\ &= \underline{\underline{9}} \end{aligned}$$

Setting Measurement Limits

You can configure the power meter to detect when a measurement has crossed over a predefined upper and/or lower limit value.

Limits are boundaries set for a certain power range and it can be applied to power, ratio or difference measurement.

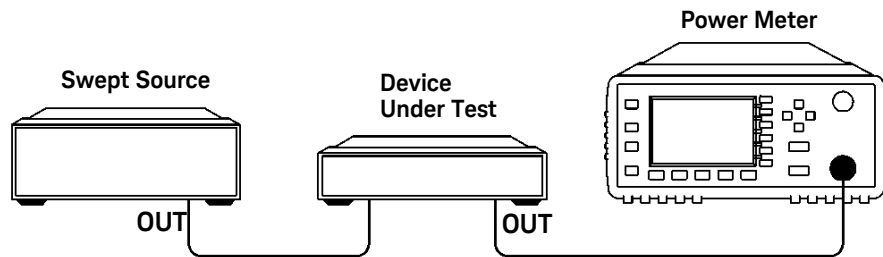

Figure 2-23 Limits checking applications

In this application a swept frequency signal is applied to the input of the Device Under Test. The power meter measures the output power. The limits have been set at +4 dBm and +10 dBm. A fail occurs each time the output power is outside these limits as shown in [Figure 2-24](#).

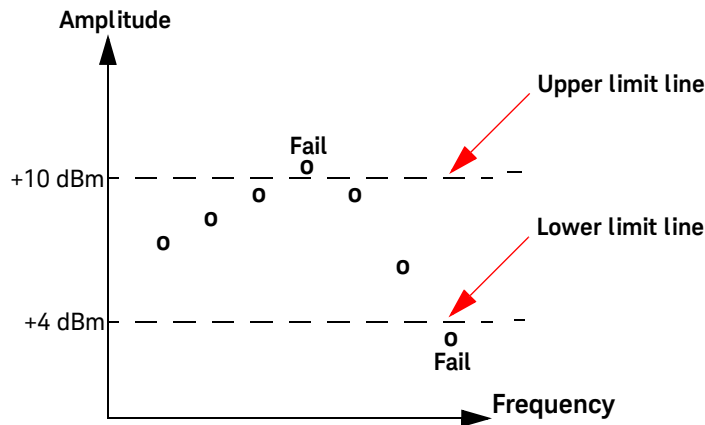

Figure 2-24 Limits checking results

Setting Limits

The power meter can be configured to verify the current measurement in any measurement line against predefined upper and/or lower limit values. The range of values that can be set for the upper and lower limits and the default values depends on the measurement units in the currently selected measurement line (see [Table 2-3](#)).

Table 2-3 Range of values for window limits







| Window Units | Maximum | Minimum | Default Maximum | Default Minimum |
|--------------|------------|----------|-----------------|-----------------|
| dB | +200 dB | -180 dB | 60 dB | -120 dB |
| dBm | +230 dBm | -150 dBm | 90 dBm | -90 dBm |
| % | 999.9 X% | 100.0 a% | 100.0 M% | 100.0 p% |
| W | 100.000 XW | 1.000 aW | 1.000 MW | 1.000 pW |

Procedure

Set the limits as follows:

NOTE

Ensure you have selected the channel you wish to set up.

- 1 Press , **Meas Select** to display the **Measurement Setup** menus.
- 2 Use the  and  keys to highlight the **Limits:** setting field.
- 3 Press  to check the **Limits:** setting field.
- 4 Use the  key to highlight the **Minimum Limits:** value field.
- 5 Press  to display the **Minimum Limit** pop-up.

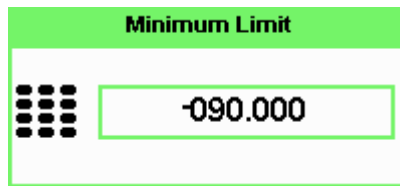





Figure 2-25 Minimum limit pop-up

- 6 Use the numeric keys to enter the required value and press **dBm**.
- 7 Use the  key to highlight the **Maximum Limits:** value field.
- 8 Press  to display the **Maximum Limit** pop-up.
- 9 Use the numeric keys to enter the required value and press **dBm**.
- 10 Press  key to close the **Measurement Setup** screen.

NOTE

The Limits can be disabled and re-enabled by checking the **Limits:** setting field.

Checking for Limit Failures

Limit failures are displayed in the appropriate field in the measurement window on the power meter's display as shown in [Figure 2-26](#).

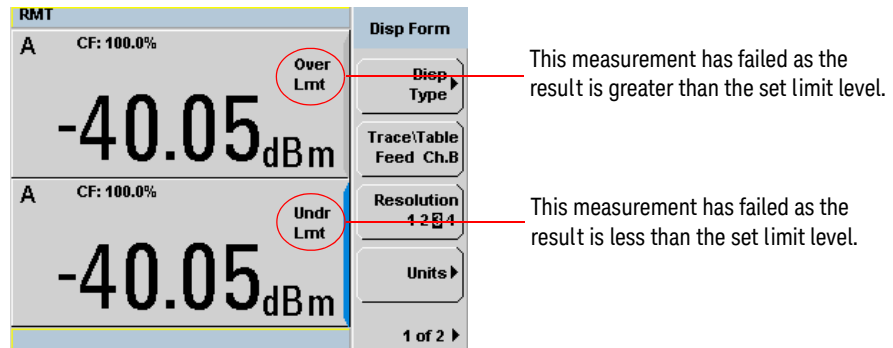



Figure 2-26 Limit failures

Numeric Format

Configure a measurement displayed in **Single Numeric** or **Dual Numeric** format as follows:

- Press  , **Meas Select** to select the measurement window or measurement line you want to configure.

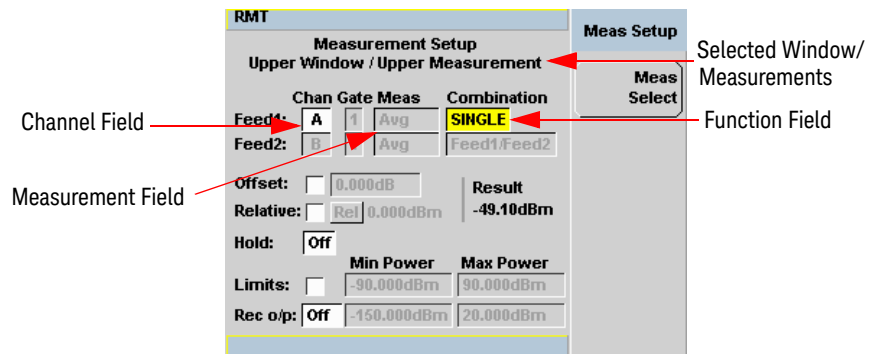

Figure 2-27 Measurement Setup showing single configuration

Single Function Measurement

Figure 2-27 shows an average measurement assigned in the upper measurement line of the upper window. (For single channel power meter, N1913A, the **Channel** field will be disabled, as shown in Figure 2-27).

NOTE

The gate field is disabled if trigger acquisition is Free Run.









- 1 Use the , , , , to highlight the **Combination** function field.
- 2 Press  to display the Function pop-up, and use the  and  to highlight **Single**.



Figure 2-28 Function pop-up

- 3 Press  to complete the entry.
- 4 The **Meas** field is set to **Avg** by default.
- 5 Press  key to complete the setup and display the measurement results.

Combined Measurement

Figure 2-29 shows a Combined Measurement configuration; Channel A and Channel C to be displayed in the upper measurement line of the upper display window. (For single channel power meter, N1913A, the **Channel** field will be disabled, as shown in Figure 2-29).

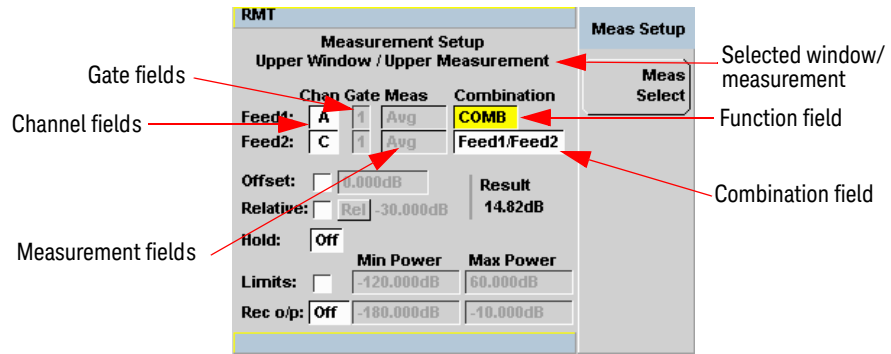

Figure 2-29 Measurement Setup showing combined configuration









- 1 Use the , , , , to highlight the **Combination** function field.
- 2 Press  to display the **Function** pop-up (see Figure 2-28) and use the  and  to highlight **Combined**.
- 3 Press  to complete the entry.
- 4 Press  key to complete the setup and display the measurements results.



Figure 2-30 Measurement example display

Max Hold/Min Hold

The max hold/min hold setting on the measurement setup window can be set on the front panel or via SCPI.

Min hold is the minimum of all measurements since the start time. The min hold reading will be updated as new minimum reading appears.

Max hold is the maximum of all measurements since the start time. The max reading will be updated as new maximum reading appears.

The max hold/min hold reading can be resettable by pressing the  key.

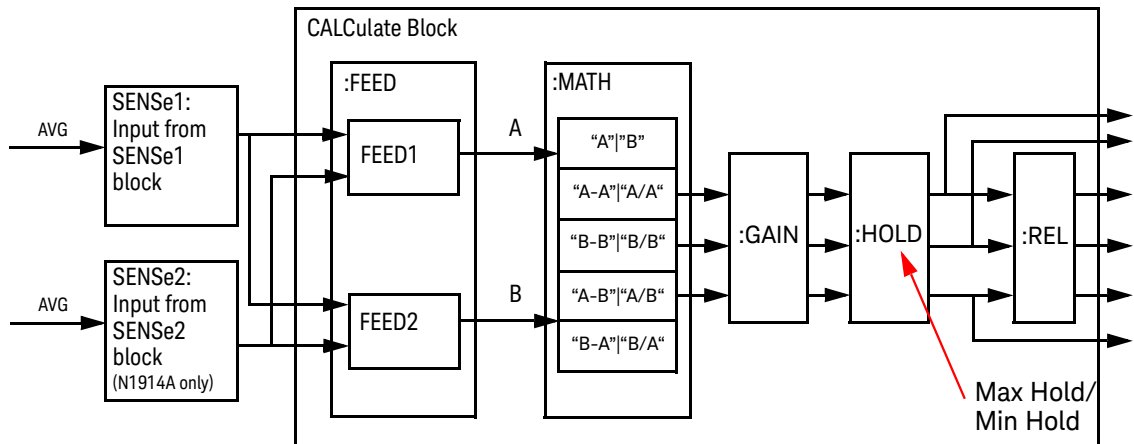

Figure 2-31 Max hold/min hold measurement is performed on the 'HOLD' block

To set max hold/min hold,











- 1 Press  to display the **Measurement Setup** menu.
- 2 Use the , , , , to highlight the **Hold** function field.
- 3 Press  to display the **Hold** pop-up, and use the  and  to highlight **Min** or **Max** (see Figure 2-32).



Figure 2-32 Hold pop-up

- 4 Press  to complete the entry.
- 5 Press  key to complete the setup and display the measurements results.

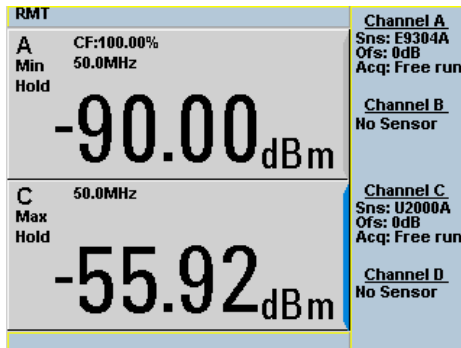



Figure 2-33 Min Hold and Max Hold measurement mode indicated in the display

- 6 Press  to display the measurement window in full screen mode. The measurement mode will be indicated in full word in the expanded window (see [Figure 2-34](#)).

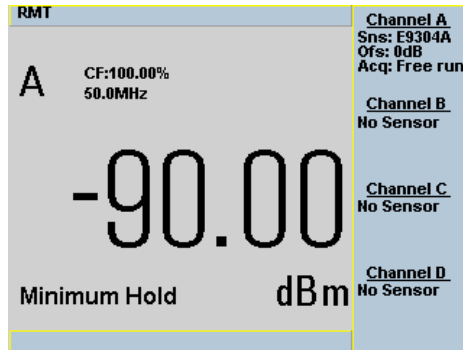



Figure 2-34 Measurement mode in full word

Recorder Output

The rear panel **Recorder Output** connectors (1 and 2) produce a dc voltage that corresponds to the power level in Watts of the selected measurement window. This dc voltage ranges from 0 to +1 Vdc. The output impedance is typically 1 k Ω .

For example, the Recorder Outputs can be used to:

- Record swept measurements
- Level an output from a source using external leveling, or
- Monitor the output power

To access the **Recorder** menu press , and enable Rec o/p. This allows you to switch the Recorder Output signal on or off and set the scaling of power levels automatically or manually. The **Max Power** and **Min Power** softkeys allow you to manually scale the power levels to represent the 1 Vdc maximum and 0 Vdc minimum output voltage of the Recorder Output. Otherwise, you can set the Recorder Output to Auto to enable auto-scaling.



In auto-scaling, the minimum power is fixed at –150 dBm and the maximum power is automatically scaled based on the current power level. The auto-scaled maximum power ranges from –140 dBm, steps every 10 dBm until +230 dBm depending on the current power level. The auto-scaling is not applicable if the measurement of the selected window is a difference, ratio, channel C, or D measurement.







Procedure

Set the recorder output as follows:

NOTE

Ensure you have selected the channel you want to set up.

- 1 Press , **Meas Select** to display the **Measurement Setup** menus.
- 2 Use the  and  keys to highlight the **Rec o/p:** setting field.

- 3 Press  to reveal the **Recorder** option menu.
- 4 Use the  and  keys to highlight the option you require.
 - The N1913A has only three options, **On**, **Auto**, or **Off**.
 - The N1914A has five options: **1**, **2**, **Auto 1**, **Auto 2**, or **Off**.
- 5 Press .
- 6 Use the  key to highlight the **Recorder Minimum:** value field.
- 7 Press  to display the **Recorder Minimum** pop-up.

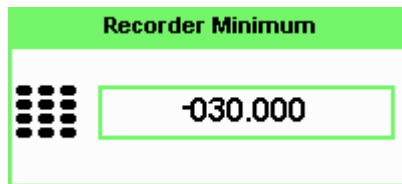



Figure 2-35 Recorder Minimum pop-up

- 8 Use the numeric keys to enter the power level you want to generate a 1 Vdc output in the **Recorder Maximum** pop-up and press **dBm**.
- 9 Use the  key to highlight the **Recorder Maximum:** value field.
- 10 Press  to display the **Recorder Maximum** pop-up.

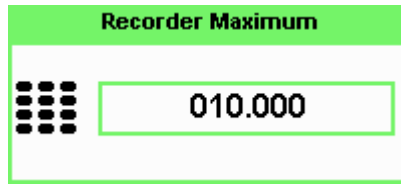



Figure 2-36 Recorder Maximum pop-up

11 Use the numeric keys to enter the power level you want to generate a 0 Vdc output in the **Recorder Minimum** pop-up and press **dBm**.

12 Press  key to close the **Measurement Setup** screen.

NOTE

The recorder output can be disabled and re-enabled by checking the **Rec o/p**: setting field.

The highest power you are going to measure is used to determine the value which you should set for the **Recorder Output** maximum setting. For example, if you are measuring a power less than 1 mW and greater than 100 mW, then set the recorder maximum value to 1 mW.

Table 2-4 Ranges of recorder output setting

| Log | 50 | 40 | 30 | 20 | 10 | 0 |
|-----|--------|-------|------|--------|-------|------|
| Lin | 100 W | 10 W | 1 W | 100 mW | 10 mW | 1 mW |
| Log | -10 | -20 | -30 | -40 | -50 | -60 |
| Lin | 100 mW | 10 mW | 1 mW | 100 nW | 10 nW | 1 nW |

Saving and Recalling Power Meter States

To reduce repeated setup sequences, you can save a maximum of ten power meter states in the non-volatile memory.

The save/recall functions are part of the **Sys/Inputs** menu, accessed by pressing the  key.

To save a measurement setup:

- 1 Press , **Save/Recall** to display the **Save/Recall** screen as shown in [Figure 2-37](#).

| RMT | | Save/Recall |
|------------|-----------|-------------|
| Reg Name | Status | |
| 1 State1 | Available | Save |
| 2 State2 | Available | |
| 3 State3 | Available | Recall |
| 4 State4 | Available | |
| 5 State5 | Available | |
| 6 State6 | Available | Edit Name |
| 7 State7 | Available | |
| 8 State8 | Available | Done |
| 9 State9 | Available | |
| 10 State10 | Available | |
| | | 1 of 1 |

Figure 2-37 Save/Recall screen





- 2 Using the  and  keys, select an available name from the displayed list. To change the name of a register –See [Chapter 2, “Editing a Register’s Name,”](#) starting on page 101, otherwise press **Save**.
- 3 The power meter prompts you to press **Confirm** to proceed.



Figure 2-38 Save confirm pop-up

Editing a Register's Name

- 1 If you have not already done so, press , **Save/Recall**.
- 2 Use the  and  keys to select the required register and press **Edit Name**. The selected name is displayed in a pop-up window. Modify this as required:

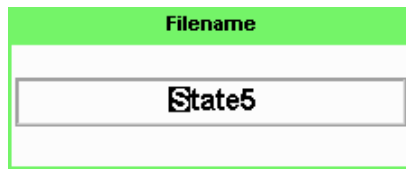









Figure 2-39 File name pop-up

- 3 Use  and  keys to modify the character on which the cursor is currently positioned.
- 4 Use  or  to move to other characters.
- 5 Use **Insert Char** and **Delete Char** as required.
- 6 To confirm your choice press **Enter**.

Recalling a Measurement Setup

- 1 Press , **Save/Recall**.
- 2 Use the  and  keys to select the required register and press **Recall**. The **Recall** key is disabled (grayed out) when an unused register is selected.

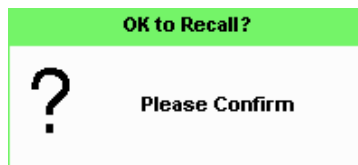

Figure 2-40 Recall pop-up

- 3 Press **Confirm**.

Zeroing and Calibrating the Power Meter

This section describes how to zero and calibrate the power meter. You should always zero the power meter prior to calibrating it.

Zeroing the Power Meter

Zeroing adjusts the power meter for a zero power reading with no power applied to the power sensor. During zeroing, which takes approximately 10 seconds, the wait symbol is displayed.



Figure 2-41 Zeroing pop-up

When to Zero?

Zeroing of the power meter is recommended:

- When a 5 °C change in temperature occurs.
- Every 24 hours.
- Prior to measuring low level signals. For example, 10 dB above the lowest specified power for your power sensor.

To zero the power meter:

- Press  and the channel **Zero** softkey.
- The **Zeroing** pop-up is displayed.

NOTE

On dual channel meters you can zero each channel independently or both channels sequentially by pressing the **Zero** softkey - choosing **Zero A**, **Zero B** or **Zero Both**

Zero/Cal Lockout

The Zero/Cal Lockout facility provides a mean of ensuring that a measurement cannot be taken until the connected sensor has been zeroed and calibrated. If the Zero/Cal Lockout facility is enabled and a sensor is connected which have not been zeroed and calibrated, then the display window for the sensor will display the message **Please Zero and Cal**.

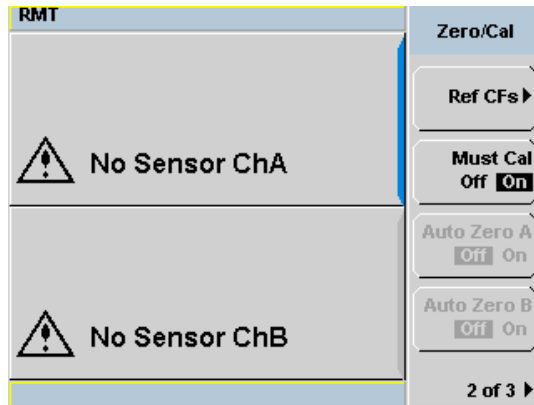

Figure 2-42 Please zero and calibrate window

When you zero the sensor, the message changes to **Please Cal**. If you calibrate the sensor before zeroing it, the message changes to **Please Zero**.

Dual channel meters display channel specific messages when a sensor is connected. The Zero/Cal Lockout configuration is applied to both channels - it cannot be applied to one channel only.

You can enable and disable the Zero/Cal Lockout facility from the System menu or the Cal menu as follow:

Press **System**, **1 of 2**, **Must Cal** **Off** or **On**. Similarly, press **Cal**, **1 of 2**, **Must Cal** **Off** or **On**.

Calibration

Calibration sets the gain of the power meter using a 50 MHz 1 mW calibrator as a traceable power reference. The power meter's POWER REF output or a suitable external reference is used as the signal source for calibration. An essential part of calibrating is setting the correct reference calibration factor for the power sensor you are using. The *N1913/1914A EPM Series Power Meter User's Guide* require you to set the reference calibration factor. The E-Series power sensors and N8480 Series power sensors (excluding Option CFT) set the reference calibration factor automatically. During calibration, the wait symbol is displayed. Offset, relative, and duty cycle settings are ignored during calibration.



Figure 2-43 Calibration wait pop-up

NOTE

During calibration, the power meter automatically switches the power reference calibrator on (if it is not already on), then after calibration, it switches it to the state it was in prior to the calibration.

Calibration Procedure Using E-Series Power Sensors and N8480 Series Power Sensors (excluding Option CFT)

The following procedure describes how you calibrate the power meter with an E-Series power sensor or N8480 Series power sensor (excluding Option CFT). Since the power meter automatically downloads the E-Series power sensor or N8480 Series power sensor (excluding Option CFT)'s calibration table, there is no requirement to enter the reference calibration factor. The power meter identifies that an E-Series power sensor or N8480 Series power sensor (excluding Option CFT) is connected and will not allow you to select certain softkeys. The text on these softkeys appears grayed out.

To calibrate:

- 1 Press  .
- 2 Connect the power sensor to the POWER REF output.
- 3 Press the **Cal** softkey to start the calibration routine. The **Calibrating** pop-up is then displayed (the power meter automatically turns on the POWER REF output).

Calibration Procedure Using 8480 Series Power Sensors and N8480 Series Power Sensors (with Option CFT)

The following procedure describes how you calibrate the power meter with the 8480 Series power sensors and N8480 Series power sensors with Option CFT.

NOTE

V8486A, W8486A, and E8486A-100 sensors

For most 8480 Series sensors, the correct (A type or D type) linearity correction table is automatically selected. However, for the V8486A, W8486A, and E8486A-100 sensors, the automatic selection must be overridden and the D type correction selected. Subsequent connection of another A type sensor will result in a warning message stating that “Linearity Override May be Required”.

To select the linearity type to be applied,

- Press , **Tables** and **Linearity** to select either **Atyp** or **Dtyp**.

There are a variety of methods to connect the power sensors to the power meter depending on the model of power sensor you are using. Refer to [Table 2-5](#) on page 107 for details on connecting different power sensor models.

- 1 Press , **2 of 3** and **Ref CFs**.

Verify the reference calibration factor of your power sensor with that displayed under **Ref CFs**. The value shown is obtained from the sensor calibration table (if one is selected), otherwise it is the last value set or the default of 100%. If the value is incorrect, press **Ref CFs**. The reference calibration factor pop-up window will be displayed. Use the numeric keypad to enter the required value in the pop-up window.

- 2 Confirm your choice by pressing **%**.
- 3 Press the **Cal** to start the calibration routine. The **Calibrating** pop-up is then displayed (the power meter automatically turns on the POWER REF output).

Table 2-5 Power Sensor Connection Requirements

| Sensor Model | Connection Requirements |
|---|---|
| Keysight 8481A Keysight 8481H Keysight 8482A Keysight 8482H Keysight N8481A Keysight N8482A Keysight E4412A Keysight E930xA Keysight E930xH Keysight E9304 H18 Keysight E9304 H19 | These power sensors connect directly to the reference calibrator. |
| Keysight 8481D Keysight 8484A | Prior to the power meter being calibrated, a Keysight 11708A 30 dB reference attenuator should be connected between the power sensor and the reference calibrator. Remove this attenuator from the power sensor input before making measurements. |
| Keysight 8483A | This power sensor requires a 75 Ω (f) to 50 Ω (m) N-Type adapter (1250-0597) to connect to the reference calibrator. Remove this adapter from the power sensor input before making measurements. |
| Keysight R8486A Keysight Q8486A Keysight V8486A Keysight W8486A Keysight E8486A Keysight R8486D Keysight Q8486D | The waveguide power sensors have two connectors. The N-Type connector is the one which is used to calibrate the power meter. |
| Keysight 8481B Keysight 8482B Keysight E930xB | These power sensors are configured with an attenuator. Prior to the power meter being calibrated, this attenuator must be removed. The attenuator must be reconnected prior to making measurements. |
| Keysight 8485A Keysight N8485A Keysight E4413A Keysight E9300A H24 Keysight E9300A H25 | This power sensor requires an APC 3.5 (f) to 50 Ω (m) N-Type adapter (08485-60005) to connect to the reference calibrator. Remove this adapter before making measurements. |

2 General Power Meter Functions

| Sensor Model | Connection Requirements |
|----------------|---|
| Keysight 8485D | Prior to the power meter being zeroed and calibrated, a Keysight 11708A 30 dB reference attenuator and an APC 3.5 (f) to 50 Ω (m) N-Type adapter (08485-60005) should be connected between the power sensor and the reference calibrator. Remove this attenuator from the power sensor input before making measurements. |
| Keysight 8487A | This power sensor requires an APC 2.4 (f) to 50 Ω (m) N-Type adapter (08487-60001) to connect to the power meter. Remove this attenuator before making measurements. |
| Keysight 8487D | Prior to the power meter being zeroed and calibrated, a Keysight 11708A 30 dB reference attenuator and an APC 2.4 (f) to 50 Ω (m) N-Type adapter (08487-60001) should be connected between the power sensor and the reference calibrator. Remove this attenuator from the power sensor input before making measurements. |

Adapter Test Procedure

System Calibration

Table 2-6 Equipment list

| Instrument | Critical specifications | Recommended model | Manufacturer |
|---|--|--|-----------------------|
| Performance network analyzer (PNA) | 10 MHz to 50 GHz | E8362B/C, E8363B/C, N5225A, or similar | Keysight Technologies |
| Adapters | 2.4 mm (f), Type-N (f) | 11903B | Keysight Technologies |
| Adapters | 2.4 mm (f), 3.5 mm (m) | 11901D | Keysight Technologies |
| Mechanical calibration kit | Type-N, 50 Ω | 85054B | Keysight Technologies |
| Mechanical calibration kit | 3.5 mm, 50 Ω | 85052B | Keysight Technologies |
| Mechanical calibration kit | 2.4 mm, 50 Ω | 85056A | Keysight Technologies |
| 11500E cable assembly, 3.5 mm (m) to 3.5 mm (m) | 3.5 mm (m) to 3.5 mm (m), DC to 26.5 GHz | 11500E | Keysight Technologies |

Table 2-7 Typical specifications

| Frequency | S-Parameter | 08485-60005 | 08487-60001 |
|-----------|-------------|--|--|
| | S11 and S22 | -58 dB | -53 dB |
| 50 MHz | S12 and S21 | -0.00665 dB (log mag) 0.999235 dB (lin mag) <0.1% | -0.006908 dB (log mag) 0.999205 dB (lin mag) <0.1% |

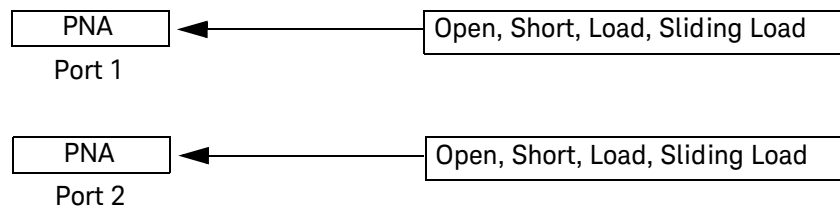

Figure 2-44 System calibration setup

- 1 Set up the equipment for system calibration according to [Figure 2-44](#).
- 2 Preset all test equipment.
- 3 Perform the following settings on the PNA:
 - Start frequency = 10 MHz
 - Stop frequency = 100 MHz
 - Number of points = 19
 - Power = -8 dBm
 - IF bandwidth = 10 Hz
 - Averaging = 1
 - Sweep time = 1 s
 - Sweep auto = true
 - Smoothing = 0%
- 4 Extend Port 1 of the PNA by connecting it to a 2.4 mm (f) to Type-N (f) adapter.
- 5 Extend Port 2 of the PNA by connecting it to a 2.4 mm (f) to 3.5 mm (f) adapter via a semi-rigid cable.
 - If you are verifying the 08487-60001, connect a 3.5 mm (f) to 2.4 mm (m) adapter to a semi-rigid cable.
- 6 Perform one port calibration (at Port 1) using the 85054B Mechanical Cal Kit (Open, Short, Load, and Sliding Load).
- 7 Perform one port calibration (at Port 2) using the 85052B/85056A Mechanical Cal Kit (Open, Short, and Load).
- 8 When the wizard prompts for a through adapter connection, attach the adapter-under-test as the unknown adapter.
- 9 The firmware will estimate the delay, which should be approximately 0.11 ns.

Device-Under-Test (DUT) Measurement



- 1 Leave the adapter-under-test in place - refer to [step 8](#).
- 2 Record the S-Parameter readings (LOG_MAG) for the PNA as **dutS11**, **dutS12**, **dutS22**, and **dutS21** respectively and compare them against the typical specifications.

Blank Screen

The blank screen feature enables you to blank the whole display screen. The feature ensures that the meter's display is not shown to casual observers.

To restore the display, press any buttons on the front panel.

To access this feature, press **System**, **1 of 2** and select **Service**. In the **Service** menu, press **1 of 2** and select **Display**. Press **Blank Screen**.

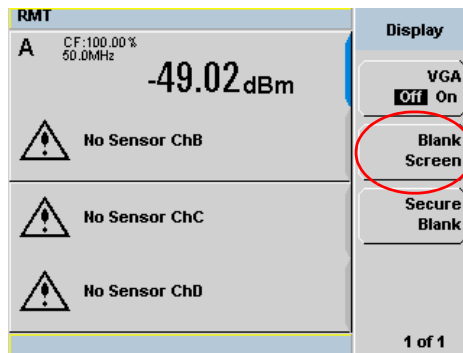

Figure 2-45 Blank screen

Secure Blank

The secure blank feature is the next level of security to the blank screen feature. The data's confidentiality can be secured with the password protection feature. To restore the display, you are required to enter the correct password.

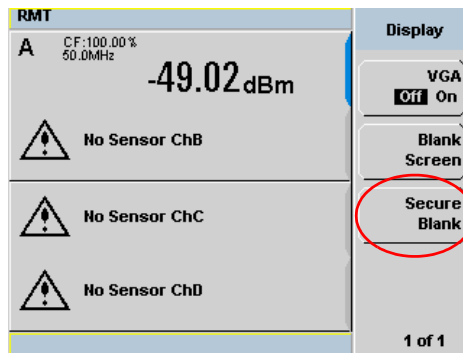



Figure 2-46 Secure Blank feature

To access the secure blank feature,

- 1 Press , **1 of 2** and select **Service**.
- 2 In the Service menu, press **1 of 2** and select **Display**.
- 3 Press **Secure Blank**. The Enter 6-digit Password pop-up is displayed. You are to enter a 6-digit password upon activating the secure blank feature (see [Figure 2-47](#)).

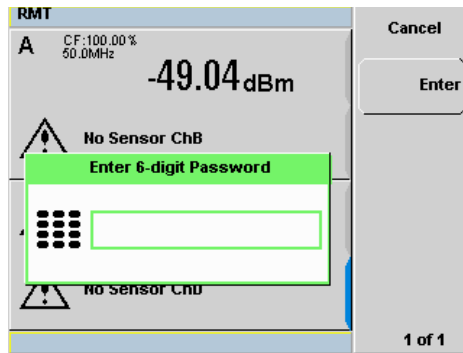

Figure 2-47 Enter 6-digit Password pop-up

- 4 The entered password will be displayed (see Figure 2-48). Press **Enter**.
- 5 A warning message pop-up will be displayed if the entered password is not 6-digits (see Figure 2-49). This warning will appear for two seconds before the Enter 6-digit Password pop-up (Figure 2-47) is displayed again.

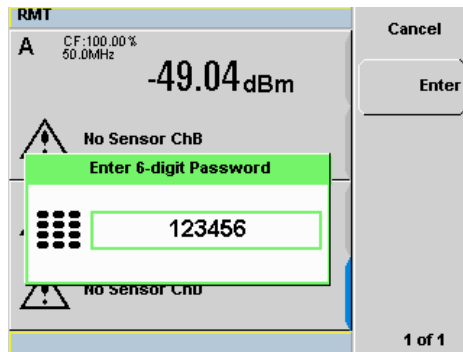

Figure 2-48 6-digit password entered

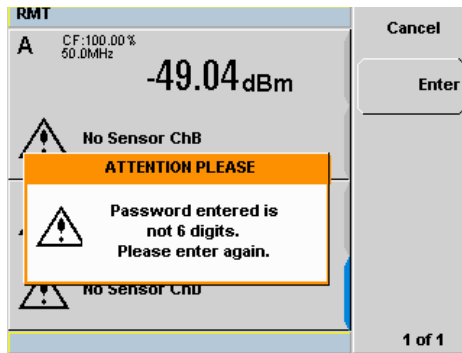

Figure 2-49 Warning message

- 6 The reconfirm password pop-up will be displayed (see [Figure 2-50](#)). You will be prompted to enter the password again for confirmation.

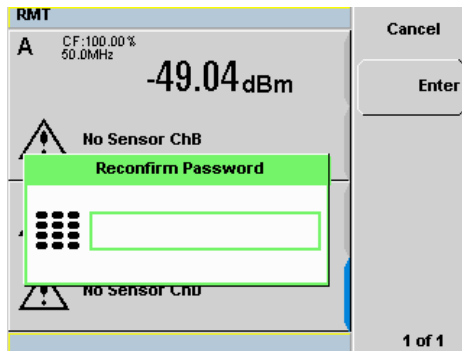

Figure 2-50 Reconfirm password

- 7 A warning message pop-up will be displayed if the password entered is different from the initial password (see [Figure 2-51](#)). This warning will appear for two seconds before the enter password pop-up is displayed again.

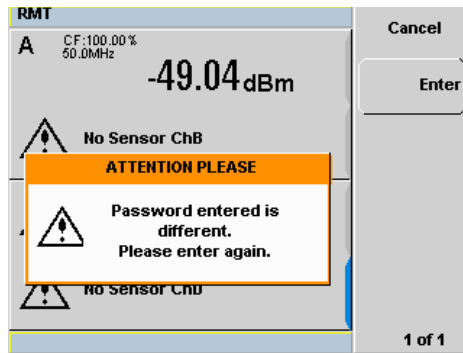

Figure 2-51 Warning message

- 8 When the correct password is successfully entered for the second time, you will be prompted for confirmation before the screen is blanked (see [Figure 2-52](#)). Press **Confirm**.

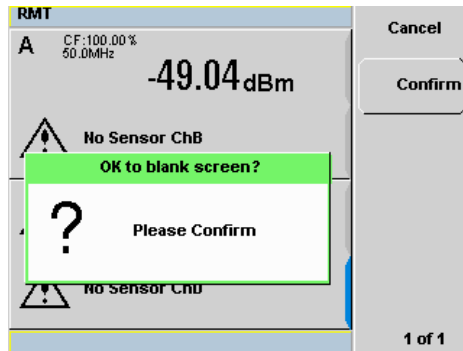

Figure 2-52 Password reconfirmation pop-up

- 9 After screen is blanked, pressing of any keys on the front panel will prompt you to enter password to restore the display (see [Figure 2-53](#)). You are allowed up to three attempts of password entry.

Upon an unsuccessful third attempt, you will need to wait for two hours with the power meter powered on before you can reenter the password. You are then allowed up to three attempts of password entry again. The whole cycle of password entry will then be repeated.

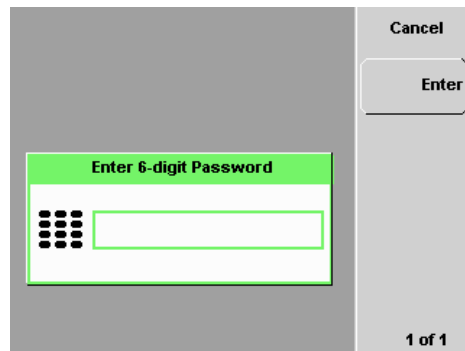

Figure 2-53 Enter password to restore display

NOTE

If you have forgotten the 6-digit password and need to operate the meter immediately, perform the Memory Erase operation. This operation will erase all data stored in the meter. Refer to **“Memory Erase/Secure Erase”** on page 119 for more details.

Backlight Intensity Control

The backlight intensity control allows you to increase or decrease the backlight brightness. This feature helps to prolong the usage hours when the meter is running under battery power.

To access this feature, press **System**, **1 of 2** and select **Service**. In the **Service** menu, press **1 of 2** and select **Backlight**.

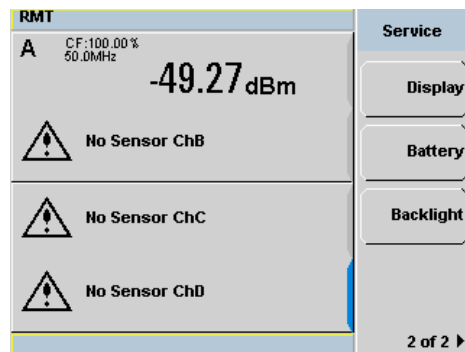

Figure 2-54 Backlight intensity control

Press **Brightness +** to increase the backlight's brightness.

Press **Brightness -** to decrease the backlight's brightness.

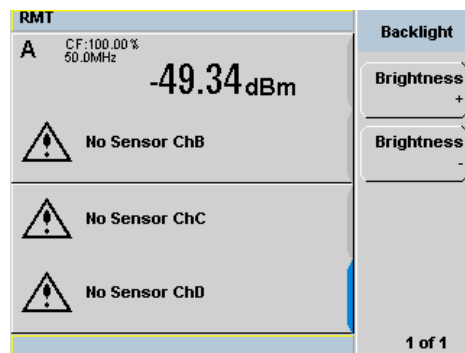

Figure 2-55 Increase or decrease the backlight brightness

Memory Erase/Secure Erase

The memory erase and secure erase features will erase the battery backed SRAM, and flash file system. The flash file system includes the power meter states, cal factor tables, frequency dependant offset tables, and the secure blank password stored in the EEPROM. Upon completion, the meter 's contents will be initialized to the default settings. These features can only be activated via the front panel.

The memory erase feature can be invoked when you forget the 6-digit password set during secure blank.

To perform memory erase/secure erase, do one of the followings:

Memory Erase

- 1 Simultaneously press the fourth softkey from the top and the  key immediately upon power-on (see [Figure 2-56](#)).
- 2 During memory erase, the splash screen will display **“Clearing Memory...”**. When memory erase is complete, **“Clearing Memory...done”** will be displayed.

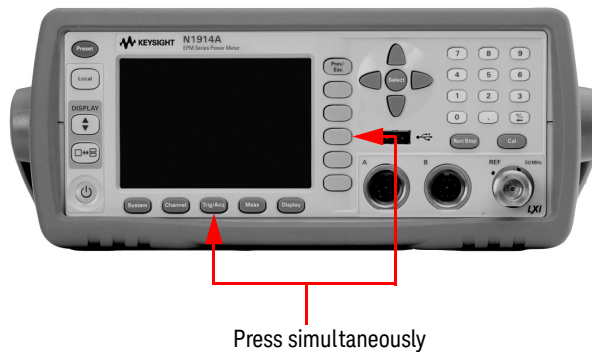

Figure 2-56 Activate memory erase using combo keys

Secure Erase

- 1 Press **System**, **1 of 2** and select **Service**. In the **Service** menu, select **Secure Erase** (see [Figure 2-57](#)).

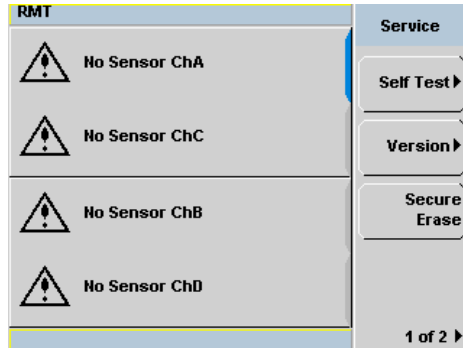

Figure 2-57 Secure Erase

- 2 A confirmation pop-up will be displayed, press **Confirm** to begin secure erase (see [Figure 2-58](#)).

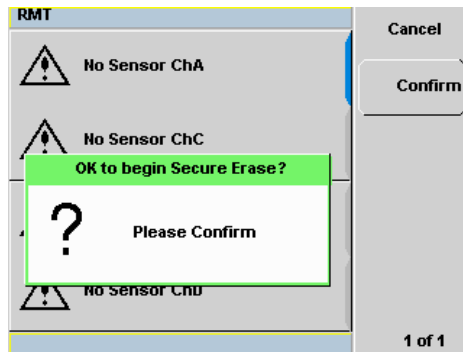

Figure 2-58 Confirmation to begin secure erase

- 3 A warning pop-up will be displayed to inform you that the secure erase is in progress (see [Figure 2-59](#)).



Figure 2-59 Warning pop-up

VGA Output (Optional)

The VGA output is used to project the meter's small display to a bigger monitor or screen. This VGA output feature is available as an orderable option.

The VGA output ON/OFF selection is provided via the front panel and SCPI. The default setting is OFF.

To access the VGA output selection,

- 1 Press **System**, **1 of 2** and select **Service**.
- 2 In the Service menu, press **1 of 2** and select **Display**.
- 3 Press **Display** to toggle ON/OFF the VGA feature (see [Figure 2-60](#)).



Figure 2-60 VGA toggle ON/OFF

Warm Start

The warm start feature allows you to retain the meter's same states and settings upon power cycle or in the event of interrupted power. The warm start ON/OFF is selectable through the front panel and SCPI. The default setting is ON.

Warm start ON

All the states entered through the front panel or remote interface will be saved. The power meter will be powered on with the states before it was powered off.

Warm start OFF

The power meter will be powered on with the default states setting.

To enable or disable the warm start feature,

- 1 Press , **1 of 2** and select **Service**.
- 2 In the Service menu, press **Warm Start Off/On** to enable or disable the warm start feature. This feature is set to ON by default (see [Figure 2-61](#)).

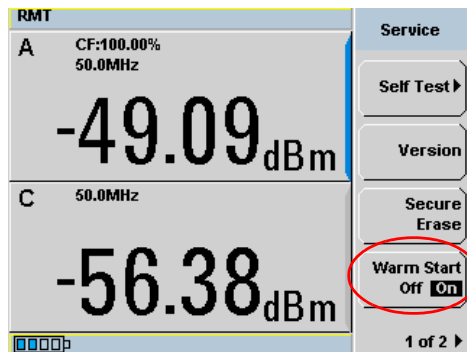

Figure 2-61 Enable/disable warm start feature

Battery Information (Optional)

The battery pack is designed for portable usage to areas where AC supply is not easily available. The battery pack is available as an orderable option.

Running Under Battery Power

A “Running under battery power” pop-up message will be displayed when

- the power meter is powered under battery power, or
- if the AC power is lost while the power meter is still connected to an AC source (applicable for power meters with battery option).

Press **Continue** to start using the meter.

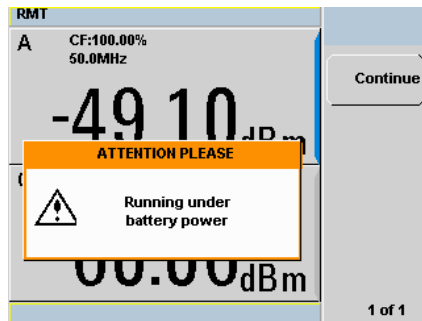

Figure 2-62 “Running under battery power” pop-up

There is a battery indicator on the display screen (see [Figure 2-63](#)) when the power meter is running under battery power. The battery level is indicated by the darker blue box inside the battery indicator.

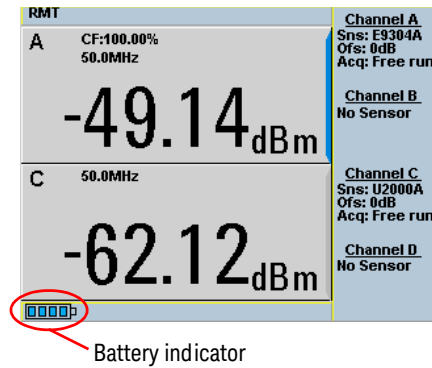



Figure 2-63 Battery indicator

Battery Menu

For power meters with battery option, to access the battery menu,

- 1 Press , **1 of 2** and select **Service**.
- 2 In the **Service** menu, press **1 of 2** and select **Battery**.

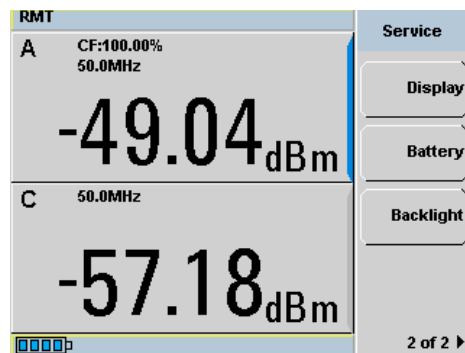

Figure 2-64 Battery menu

Battery Status Display

The meter’s system will stop charging the battery once the battery pack internal temperature is higher than 45 °C. The battery’s rated temperature range is from 0 °C to 50 °C for discharging mode. Pop-up messages will be displayed to advise you to power down the meter once the battery temperature is under or above the rated temperature.

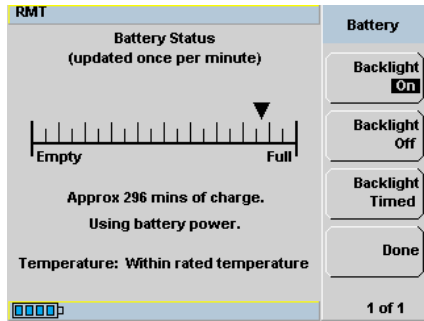

Figure 2-65 Battery status display

Low Power Battery Condition

When the power meter is running on battery power and there are less than 10 minutes of run-time remaining, a “Battery Power Low” pop-up message will be displayed. In addition, the message “Battery Low” will appear at the bottom of the display screen with the battery indicator filled with red (see Figure 2-66).

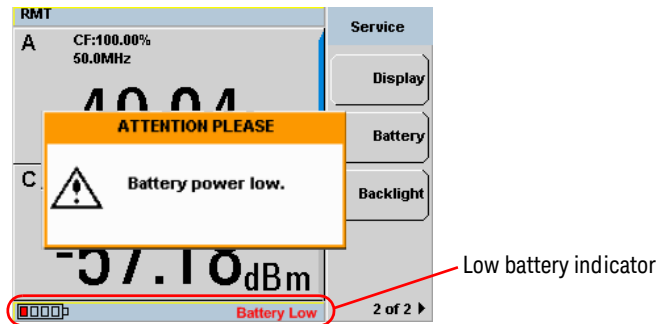

Figure 2-66 Low battery indicator

Display Backlight Control

When the battery power is being used, the display backlight control will be available. If AC power is being used, the display backlight control menu is grayed out and the backlight is permanently turned ON.

The display backlight can be turned OFF by pressing **Backlight Off** on the backlight menu. When backlight is turned OFF, pressing on any of the keys on the front panel will turn ON the backlight.

These features are intended for saving power and longer usage when the meter is running under battery power.

Press **Backlight Timed** to enable Timed mode for the display backlight. When Timed mode is selected, the backlight will turn OFF within 10 minutes after the last keypress. Pressing any keys on the front panel will turn the backlight ON again.

On instrument preset, the backlight will be set to ON.

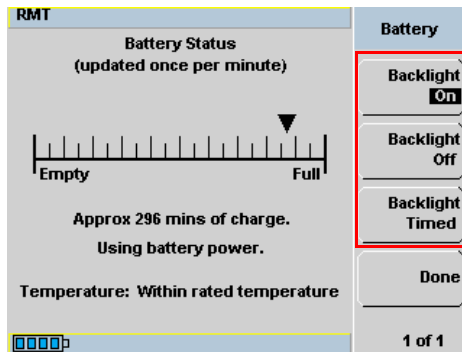

Figure 2-67 Display backlight control

Battery General Information

Please use this information to maintain your power meter battery in optimum condition and prolong its operating life.

Battery Storage

If left unused, a fully charged battery discharges over a period of time. A fully charged battery removed from a power meter and stored for a maximum of two months retains a low-level charge. When a battery in this low-charge state is fitted to a power meter, several hours charging may be required before the power meter indicates the battery is charging.

Storage temperature limits: $-20\text{ }^{\circ}\text{C}$ to $60\text{ }^{\circ}\text{C}$, $\leq 80\%$ RH

CAUTION

In extreme cases of discharge, when the battery has been stored in excess of two months, recovery may not be possible and a replacement battery is required. A battery that remains discharged after two days on charge can be assumed discharged beyond recovery - a replacement is required.

Failing Battery

The battery can be charged and discharged numerous times but due to battery chemistry characteristics, the operation time decreases. When the battery powered operation time of your power meter becomes noticeably shorter, it is time to order a new battery.

To obtain a replacement battery, order Keysight part number N1913-37900.

WARNING

- This battery pack uses Lithium-ion (Li-ion) batteries.
- Do not short circuit the battery terminals.
- Do not subject the battery to excessive heat.
- Do not dispose of by burning.
- Lithium-ion (Li-ion) cells are considerably more environmentally friendly than Nickel-Cadmium (NiCD) cells but you should follow battery safety guidelines.
- Refer to your local country regulatory requirements on the disposal of Lithium-ion (Li-ion) batteries

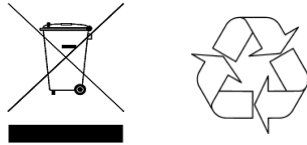

Running Time

Typical running times and conditions as follows:

| Power Meter Model | Sensor LCD Backlight ON | Sensor LCD Backlight OFF | No Sensor LCD Backlight ON | No Sensor LCD Backlight OFF |
|-------------------|-------------------------|--------------------------|----------------------------|-----------------------------|
| N1913A N1914A | Up to 6 hours | Up to 7 hours 20 minutes | Up to 6 hours 15 minutes | Up to 7 hours 30 minutes |

CAUTION

Use the battery only for its intended purpose. Only use the Keysight battery option power meter models to charge the battery.

The battery packs should be stored in an environment with low humidity and free from corrosive gas at a recommended temperature range <21 °C. Extended exposure to temperatures above 45 °C could degrade the battery’s performance and life.

Setting the Cable Short/Long

When connecting the power sensor with Keysight 11730F power sensor cable, 61 m (200 ft), you are required to change the cable setting from **Short** (default setting) to **Long**, or an error will occur when the power sensor is connected.

To access the cable setting,

- 1 Press **System**, **1 of 2** and select **Service**.
- 2 In the **Service** menu, press **1 of 2** and select **Cable Short/Long** to toggle between the short or long cable option.

The **LCB** indicator will appear in blue at the bottom of the display to indicate that the long cable option is selected as shown in [Figure 2-68](#).

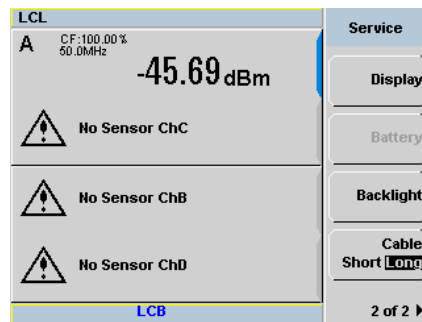

Figure 2-68 Short/long cable option

3 Using E9300 E-Series Power Sensors

| | |
|--|-----|
| Introduction | 132 |
| Power Meter Configuration | 133 |
| Measurement Accuracy | 135 |
| Measuring Spread Spectrum and Multitone Signals | 138 |
| Measuring TDMA Signals | 141 |
| Electromagnetic Compatibility (EMC) Measurements | 143 |
| Measurement Accuracy and Speed | 144 |

This chapter describes how to use your E9300 E-Series power sensors with N1913/1914A EPM Series power meters.

Introduction

The E9300 E-Series power sensors are true average, wide dynamic range RF microwave power sensors. They are based on a dual sensor diode pair/attenuator/diode pair. This technique ensures the diodes in the selected signal path are kept in their square law region, thus the output current (and voltage) is proportional to the input power. The diode pair/attenuator/diode pair assembly can yield the average of complex modulation formats across a wide dynamic range, irrespective of signal bandwidth. Further refinements are included to improve power handling allowing accurate measurement of high level signals with high crest factors without incurring damage to the sensor.

These sensors measure average RF power on a wide variety of modulated signals and are independent of the modulation bandwidth. They are ideally suited to the average power measurement of multi-tone and spread spectrum signals such as CDMA, W-CDMA and digital television formats.

Please refer to the documentation supplied with your E-Series E9300 power sensor for specification and calibration information.

Power Meter Configuration

The N1913/1914A EPM Series power meters automatically recognize an E-Series E9300 power sensor when it is connected. The sensor calibration data is automatically read by the power meter. The power meter also configures the auto-averaging settings shown in Figure 3-1 to suit the power sensor characteristics.

| | E9300/1/4A | E9300/1H | E9300/1B | Maximum Sensor Power | Resolution Setting | | | | Number of Averages | |
|----------------------|-------------|----------|-------------------------|-------------------------|--------------------|-----|-----|-----|--------------------|--|
| | | | | | 1 | 2 | 3 | 4 | | |
| Sensor Dynamic Range | Upper Range | | | | | | | | | |
| | 10 dBm | 20 dBm | 40 dBm | ----- | 1 | 1 | 1 | 4 | Number of Averages | |
| | 2 dBm | 12 dBm | 32 dBm | ----- | 1 | 1 | 4 | 16 | | |
| | -4 dBm | 6 dBm | 26 dBm | ----- | 1 | 1 | 8 | 32 | | |
| | -10 dBm | 0 dBm | 20 dBm | ----- | 1 | 4 | 16 | 128 | | |
| | | | | ----- | 1 | 16 | 64 | 128 | | |
| | Lower Range | | | | | | | | | |
| | -20 dBm | -10 dBm | 10 dBm | ----- | 1 | 1 | 1 | 4 | | |
| | -30 dBm | -20 dBm | 0 dBm | ----- | 1 | 1 | 2 | 16 | | |
| | -40 dBm | -30 dBm | -10 dBm | ----- | 1 | 2 | 16 | 64 | | |
| -50 dBm | -40 dBm | -20 dBm | ----- | 4 | 16 | 128 | 256 | | | |
| | | | ----- | 32 | 64 | 256 | 256 | | | |
| | | | Minimum Sensor Power | | | | | | | |

Figure 3-1 E9300 E-Series auto-averaging settings

NOTE

These values are valid only for the power meter channel connected with E-Series E9300 power sensor. You can also configure the settings manually – refer to “Achieving Stable Results with TDMA Signals” on page 141 if required.

Default Channel Setup

When an E-Series E9300 power sensor is connected the following **Channel Setup** is automatically configured. Carrying out a Preset returns the power meter to this configuration.

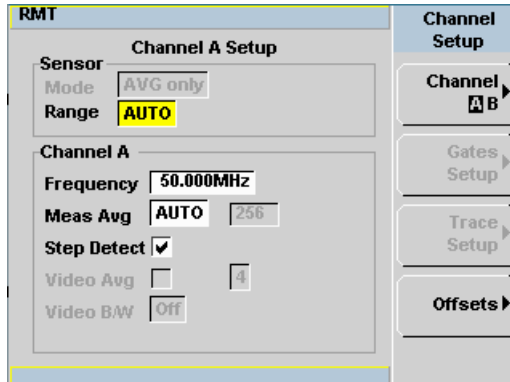

Figure 3-2 E9300 E-Series sensor default channel setup

Measurement Accuracy

Power sensors have small errors in their response over frequency. The response of each sensor is measured during manufacture to determine correction factors. With E-Series power sensors, correction factors are held in Electrically Erasable Programmable Read Only Memory (EEPROM) and are downloaded to the power meter automatically.

Using calibration factors enables improved measurement accuracy. This section describes making average power measurements using the E9300 E-Series power sensors.



Making a measurement requires the following steps:

- 1 Zero and calibrate the power meter/sensor combination.
- 2 Set the frequency for the signal you want to measure.
- 3 Make the measurement.

Table 3-1 Power sensor connection requirements

| Sensor | Connection Requirements |
|--|---|
| E9300A E9300H E9301A E9301H E9304A | These power sensors connect directly to the POWER REF. |
| E9300B E9301B | These power sensors are configured with an attenuator. Prior to calibration this attenuator must be removed. Replace the attenuator before making measurements. |

Procedure





- 1 Zero and calibrate the power meter/sensor combination.
- 2 Ensure the power sensor is disconnected from any signal source.
- 3 Press  and the channel **Zero** softkey. The **Zeroing** pop-up is displayed.
- 4 Connect the power sensor to the POWER REF output.
- 5 Press  and the channel **Cal** softkey to start the calibration routine. The **Calibrating** pop-up is then displayed.

NOTE

You can reduce the steps required to carry out the zero and calibration procedure as follows:

- Connect the power sensor to the POWER REF output.
- Press  and **Zero + Cal** . (For dual channel meters, press **Zero + Cal** , **Zero + Cal A** or **Zero + Cal B** as required).

Now set the frequency of the signal you want to measure. The power meter automatically selects the appropriate calibration factor.

- 6 Press  . On dual channel meters select the required channel.
- 7 Use the  and  keys to highlight the **Frequency** value field and press  to display the **Frequency** pop-up. Use the numeric keypad to enter the required value in the **Frequency** pop-up window.

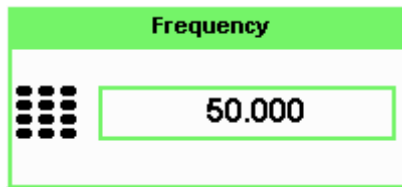



Figure 3-3 Frequency pop-up

8 Confirm your choice by pressing **MHz** or **GHz**.

9 Press  key to close the **Channel Setup** screen.

10 Proceed to make the measurement.

11 Reconnect any required attenuators or adaptors and connect the power sensor to the signal to be measured.

The corrected measurement result is displayed.

Measuring Spread Spectrum and Multitone Signals

To achieve high data transfer rates within a given bandwidth, many transmission schemes are based around phase and amplitude (I and Q) modulation. These include CDMA, W-CDMA and digital television. The signals are characterized by their appearance on a spectrum analyzer display – a high amplitude noise-like signal of bandwidths up to 20 MHz. An 8 MHz bandwidth digital television signal is shown in [Figure 3-4](#).

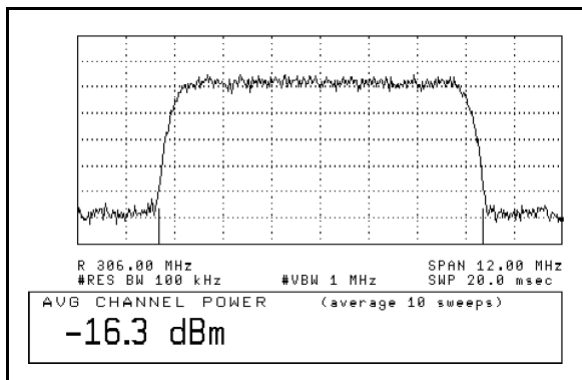

Figure 3-4 Spread spectrum signal

The diode pair/attenuator/diode pair architecture of the E9300 E-Series power sensors is ideally suited to the average power measurement of these signals. The sensors have wide dynamic range (80 dB max, sensor dependent) and are bandwidth independent.

Some signal modulation formats such as orthogonal-frequency-division multiplexing (OFDM) and CDMA have large crest factors. The E-Series E9300/1/4A power sensors can measure +20 dBm average power even in the presence of +13 dB peaks but the peak pulse duration must be less than 10 microseconds. For high power applications, such as base-station testing, the E9300/1B and E9300/1H are recommended.

CDMA Signal Measurements

Figure 3-5 and Figure 3-6 show typical results obtained when measuring a CDMA signal. In these examples, the error is determined by measuring the source at the amplitude of interest, with and without CDMA modulation, adding attenuation until the difference between the two values stops changing. The CW sensor in Figure 3-5 uses correction factors to correct for power levels beyond its square law operating region.

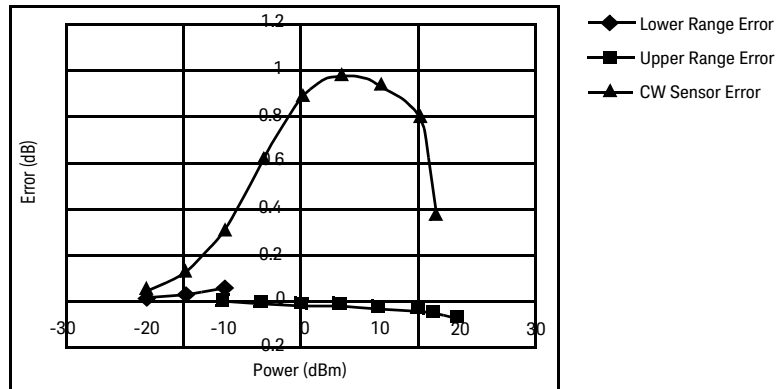

Figure 3-5 Wideband CDMA error of E-Series E9300 power sensor versus corrected CW sensor

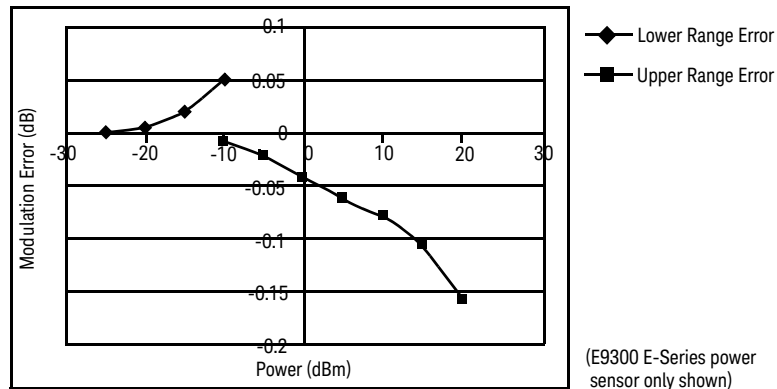

Figure 3-6 CDMA (IS-95A): 9Ch Fwd

Multitone Signal Measurements

In addition to wide dynamic range, the E9300 E-Series power sensors also have an exceptionally flat calibration factor versus frequency response as shown in [Figure 3-7](#). This is ideal for amplifier intermodulation distortion measurements where the components of the two-tone or multitone test signal can be separated by hundreds of MHz.

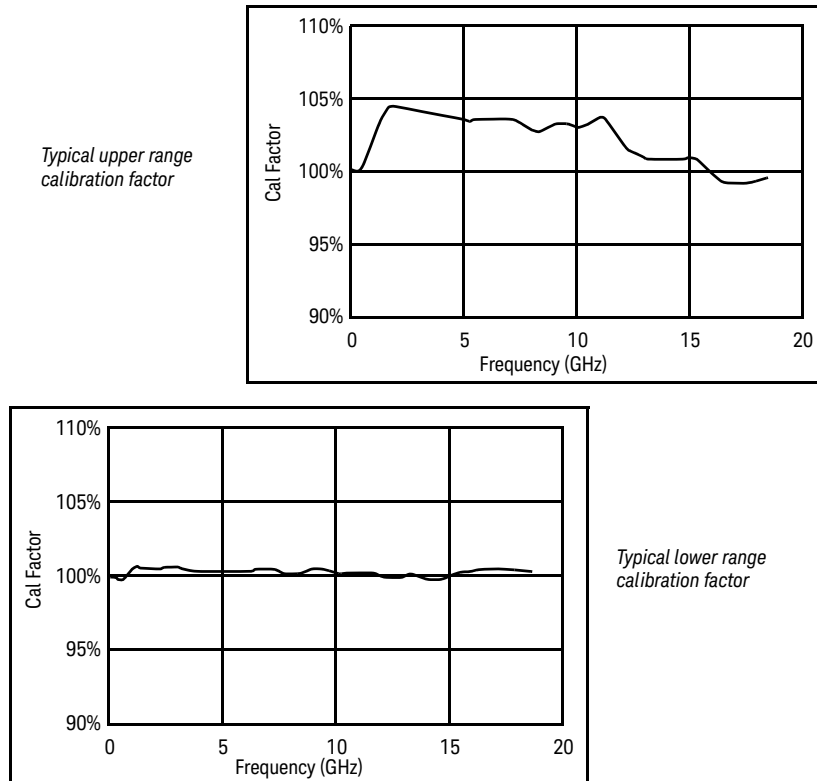

Figure 3-7 Calibration factors versus frequency

Measuring TDMA Signals

Power Meter and Sensor Operation

The voltages generated by the diode detectors in the power sensor can be very small. Gain and signal conditioning are required to allow accurate measurement. This is achieved using a 400 Hz square wave output from the power meter to drive a chopper-amplifier in the power sensor. Digital Signal Processing (DSP) of the generated square wave is used by the power meter to recover the power sensor output and accurately calculate the power level.







The chopper-amplifier technique provides noise immunity and allows large physical distances between power sensor and power meter. Additional averaging helps reduce noise susceptibility.

Achieving Stable Results with TDMA Signals

The averaging settings in the power meter are designed to reduce noise when measuring continuous wave (CW) signals. Initial measurement of a pulsed signal may appear unstable with jitter on the less significant displayed digits. With pulsed signals the averaging period must be increased to allow measurement over many cycles of the pulsed signal.

Procedure

Set the averaging as follows:

- 1 Press . On dual channel meters, select the required channel.
- 2 Use the  and  keys to select the **Filter** setting field.
- 3 Press  and use the  and  keys to step through the available settings. Select **MAN**.
- 4 Use the  key to select the **Meas Avg:** value field.





- 5 Press  to display the **Meas Avg Count** pop-up.
- 6 Use the numeric keys to enter the required value.
- 7 Press **Enter** to complete the entry.

NOTE

Ensure that the filter is not reset when a step increase or decrease in power is detected by switching the step detection off.

Procedure

Switch off step detection as follows:

- 1 Press . On dual channel meters, select the required channel.
- 2 Use the  and  keys to select the **Step Detect** setting field.
- 3 Press  to check the step detection to **Off**.
- 4 Press  key to close the **Channel Setup** screen.

Achieving Stable Results with GSM Signals

Signals with a pulse repetition frequency (PRF) close to a multiple or a submultiple of the 440 Hz chopper-amplifier signal generate a beat note at a frequency between the PRF and 4F400Hz0 Hz. Control over the filter settings is again required to obtain stable results.

- Tip** The PRF of a GSM signal is approximately 217 Hz and thus requires more averaging than most other TDMA signals. To achieve a stable measurement use the filter setting procedures to set the **Length** . Experimentally, a **Length** setting of 148 gives optimum results although settings in the order of 31 or 32 give acceptable results if a faster measurement is required.

Electromagnetic Compatibility (EMC) Measurements

The low frequency range of the E9304A make it the ideal choice for making EMC measurements to CISPR (Comite International Special Perturbations Radioelectriques) requirements, and electromagnetic interference (EMI) test applications such as the radiated immunity test (IEC61000-4-3).

DC coupling of the E9304A input allows excellent low frequency coverage. However, the presence of any dc voltages mixed with the signal has an adverse effect on the accuracy of the power measurement.

CAUTION

The E9304A sensor is DC coupled. DC voltages in excess of the maximum value (5 VDC) can damage the sensing diode.

Measurement Accuracy and Speed

The power meter has no internal ranges. The only ranges you can set are those of the E9300 E-Series power sensors (and other Keysight Technologies E-Series power sensors). With an E-Series E9300 power sensor the range can be set either automatically or manually. Use autoranging when you are not sure of the power level you are about to measure.

CAUTION

To prevent damage to your sensor do not exceed the power levels specified in the sensor user's guide. The E9304A sensor is DC coupled. DC voltages in excess of the maximum value (5 VDC) can damage the sensing diode.

Setting the Range

There are two manual settings, **LOWER** and **UPPER**. The **LOWER** range uses the more sensitive path and the **UPPER** range uses the attenuated path in the E9300 E-Series power sensors.







| Sensor | LOWER range | UPPER range |
|------------|--------------------|--------------------|
| E9300/1/4A | -60 dBm to -10 dBm | -10 dBm to +20 dBm |
| E9300/1B | -30 dBm to +20 dBm | +20 dBm to +44 dBm |
| E9300/1H | -50 dBm to 0 dBm | 0 dBm to +30 dBm |

The default is **AUTO**. In **AUTO** the range crossover value depends on the sensor model being used.

| E9300/1/4A | E9300/1B | E9300/1H |
|-----------------------|-----------------------|---------------------|
| -10 dBm \pm 0.5 dBm | +20 dBm \pm 0.5 dBm | 0 dBm \pm 0.5 dBm |

Procedure

Set the range as follows:

- 1 Press . On dual channel meters, select the required channel.
- 2 Use the  and  keys to select the **Range**: setting field.
- 3 Press  to display the **Range** pop-up.
- 4 Use the  and  keys to select the required setting.
- 5 Press  to complete the entry.

Measurement Considerations

While autoranging is a good starting point, it is not ideal for all measurements. Signal conditions such as crest factor or duty cycle may cause the power meter to select a range which is not the optimum configuration for your specific measurement needs. Signals with average power levels close to the range switch point require you to consider your needs for measurement accuracy and speed. For example, using an E9300/1/4A sensor, where the range switch point is -10 ± 0.5 dBm in a pulsed signal configured as follows:

| Characteristic | Value |
|----------------|--------|
| Peak Amplitude | -6 dBm |
| Duty Cycle | 25% |

The calculated average power is -12 dBm.

Accuracy

The value of -12 dBm lies in the lower range of the E-Series E9300 power sensor. In autoranging mode (“**AUTO**”), the power meter determines the average power level is below -10 dBm and selects the low power path. However, the peak amplitude of -6 dBm is beyond the specified, square law response range of the low power path diodes. The high power path (-10 dBm to $+20$ dBm) should be used to ensure a more accurate measurement of this signal. However, range holding in “**UPPER**” (the high power path), for a more accurate measurement, results in considerably more filtering.

Speed and Averaging

The same signal also requires that consideration is given to measurement speed. As shown above, in autoranging mode the power meter selects the low power path in the E-Series E9300 power sensor. With auto-averaging also configured, minimal filtering is applied. Values of 1 to 4 for average power levels above -20 dBm are used in the low power path. (Refer to “**E9300 E-Series auto-averaging settings**” on page 133.)

If the range is held in “**UPPER**” for more accuracy, the measurement is slower. More filtering is applied due to the increase in noise susceptibility at the less sensitive area of the high power path. Values of 1 to 128 for average power levels less than -10 dBm are used. (Again, refer to “**E9300 E-Series auto-averaging settings**” on page 133.) Manually lowering the filter settings speeds up the measurement but can result in an unwanted level of jitter.

Summary

Attention must be paid to signals whose average power levels are in the low power path range whilst their peaks are in the high power path range. You can achieve best accuracy by selecting the high power path or best speed by selecting the low power path.

4 Using E4410 E-Series Power Sensors

| | |
|---------------------------|-----|
| Introduction | 148 |
| Power Meter Configuration | 149 |
| Measurement Accuracy | 151 |

This chapter describes how to use your E4410 E-Series power sensors with N1913/1914A EPM Series power meters.

Introduction

The E4410 E-Series power sensors are diode based power sensors. They are intended for the measurement of CW microwave power levels in a wide dynamic range from -70 dBm to $+20$ dBm (100 pW to 100 mW). These are high-speed power sensors, and do not incorporate narrow-bandwidth averaging used in average-power sensors. Signals with digital, pulse, or other forms of amplitude modulation may introduce measurement errors.

Multi-tone signals (containing multiple frequency components), or signals with significant harmonic content (> -45 dBc) may introduce measurement errors at high power levels.

Please refer to the documentation supplied with your E-Series E4410 power sensor for specification and calibration information.

Power Meter Configuration

The N1913/1914A EPM Series power meters automatically recognize an E-Series E4410 power sensor when it is connected. The sensor calibration data is automatically read by the power meter. Also, the power meter automatically configures the averaging as shown in [Figure 4-1](#).

| | Maximum Sensor Power | Resolution Setting | | | | Number of Averages |
|-------|----------------------|--------------------|---|-----|-----|--------------------|
| | | 1 | 2 | 3 | 4 | |
| | | 1 | 1 | 1 | 8 | |
| 10 dB | | 1 | 1 | 1 | 16 | |
| 10 dB | | 1 | 1 | 2 | 32 | |
| 10 dB | | 1 | 1 | 16 | 256 | |
| 10 dB | | 1 | 8 | 128 | 128 | |
| | Minimum Sensor Power | | | | | |

Figure 4-1 E-Series CW sensor auto-averaging settings

NOTE

These values are valid only for the power meter channel connected with E-Series E4410 power sensor. Averaging settings can also be manually configured.

Default Channel Setup

When an E-Series E4410 power sensor is connected the following **Channel Setup** is automatically configured. Carrying out a Preset returns the channel to this configuration.

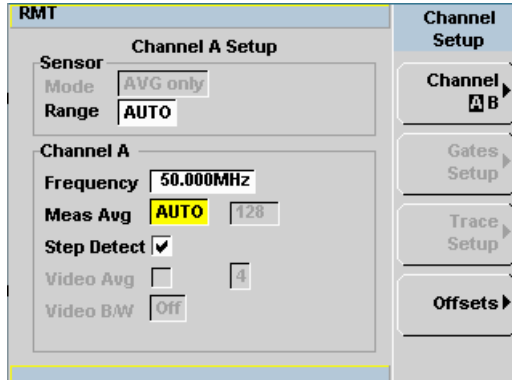

Figure 4-2 E-Series E4410 sensor default channel setup

Measurement Accuracy



Power sensors have small errors in their response over frequency. The response of each sensor is measured during manufacture (and during periodic calibration). With E-Series power sensors, the resulting frequency compensation information is written into Electrically Erasable Programmable Read Only Memory (EEPROM). This allows the frequency and calibration data to be downloaded to the power meter automatically.

Using calibration factors enables you to achieve improved measurement accuracy. This section describes making continuous wave measurements using the E4410 E-Series power sensors.

Making a measurement requires the following steps:

- 1 Zero and calibrate the power meter/sensor combination.
- 2 Set the frequency for the signal you want to measure.
- 3 Make the measurement.

Procedure





- 1 Zero and calibrate the power meter/sensor combination.
- 2 Ensure the power sensor is disconnected from any signal source.
- 3 Press  and the channel **Zero** softkey. The **Zeroing** pop-up is displayed.
- 4 Connect the power sensor to the POWER REF output.
- 5 Press  and the channel **Cal** softkey to start the calibration routine. The **Calibrating** pop-up is then displayed.

NOTE

You can reduce the steps required to carry out the zero and calibration procedure as follows:

- Connect the power sensor to the POWER REF output.
- Press  and **Zero + Cal**. (For dual channel meters, press **Zero + Cal**, **Zero + Cal A** or **Zero + Cal B** as required).

Now, set the frequency of the signal you want to measure. The power meter automatically selects the appropriate calibration factor.

- 6 Press . On dual channel meters select the required channel.
- 7 Use the  and  keys to highlight the **Frequency** value field and press  to display the **Frequency** pop-up. Use the numeric keypad to enter the required value in the **Frequency** pop-up window.

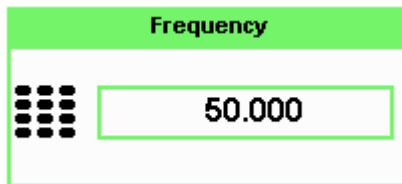



Figure 4-3 Frequency pop-up

- 8 Confirm your choice by pressing **MHz** or **GHz**.
- 9 Press  key to close the **Channel Setup** screen. Make the measurement now.
- 10 Connect the power sensor to the signal to be measured. The corrected measurement result is displayed.

5 Using 8480 Series Power Sensors

| | |
|--|-----|
| Introduction | 154 |
| Power Meter Configuration | 155 |
| Measurement Accuracy | 158 |
| Frequency Specific Calibration Factors | 159 |
| Sensor Calibration Tables | 163 |

This chapter describes how to use your 8480 Series power sensors with N1913/1914A EPM Series power meter.

Introduction

The 8480 Series offers a wide range of both thermocouple and diode based power sensors. Many have very specific applications, for example the 110 GHz W8486A or the +44 dBm 8482B. However, they do not have their calibration factors stored in EEPROM, unlike all E-Series, and require that you use default calibration tables or manually enter the required correction factors. Likewise, they cannot be used to make peak or time gated measurements.

Please refer to the documentation supplied with your Keysight 8480 Series power sensors for specification and calibration information.

Power Meter Configuration

The N1913/1914A EPM Series power meters automatically recognize an 8480 Series power sensor when it is connected. The averaging settings shown in [Figure 5-1](#) are automatically configured.

| | Maximum Sensor Power | Resolution Setting | | | | Number of Averages |
|-------|----------------------|--------------------|---|-----|-----|--------------------|
| | | 1 | 2 | 3 | 4 | |
| | | 1 | 1 | 1 | 8 | |
| 10 dB | | 1 | 1 | 1 | 16 | |
| 10 dB | | 1 | 1 | 2 | 32 | |
| 10 dB | | 1 | 1 | 16 | 256 | |
| 10 dB | | 1 | 8 | 128 | 128 | |
| | Minimum Sensor Power | | | | | |

The diagram includes vertical arrows on the left labeled 'Power Sensor Dynamic Range' and on the right labeled 'Number of Averages'. Horizontal dashed lines separate the rows, and vertical double-headed arrows indicate 10 dB intervals between the power levels.

Figure 5-1 8480 Series auto-averaging settings

NOTE

These values are valid only for the power meter channel connected with Keysight 8480 Series power sensors. Averaging settings can also be manually configured.

Default Channel Setup

Figure 5-2 shows the **Channel Setup** configured automatically. Presetting returns the power meter to this configuration.

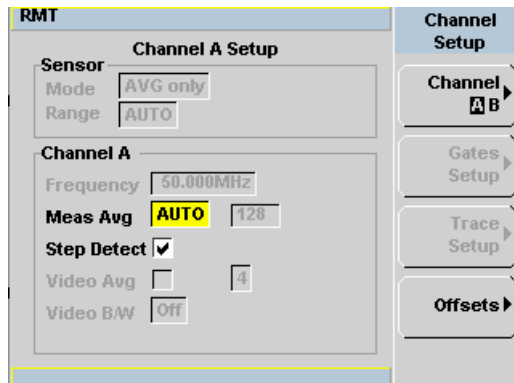

Figure 5-2 8480 Series sensor default channel setup

8480 Series Sensors Connection Requirements

Table 5-1 8480 Series connection requirements

| Sensor | Connection Requirements |
|---|--|
| 8481A 8481H 8482A 8482H | These power sensors connect directly to the POWER REF. |
| 8481D 8484A | Prior to calibration, a Keysight 11708A 30 dB reference attenuator should be connected between the power sensor and the POWER REF. Remove this attenuator from the power sensor input before making measurements. |
| 8483A | This power sensor requires a 75 Ω (f) to 50 Ω (m) N-Type adapter (1250-0597) to connect to the POWER REF. Remove this adapter before making measurements. |
| R8486A Q8486A V8486A W8486A E8486A R8486D Q8486D | These waveguide power sensors have two connectors. Use the N-Type connector to calibrate the power meter. |
| 8481B 8482B | These power sensors are configured with an attenuator. Prior to calibration this attenuator must be removed. Replace the attenuator before making measurements. |
| 8485A | This power sensor requires an APC 3.5 (f) to 50 Ω (m) N-Type adapter (08485-60005) to connect to the POWER REF. Remove this adapter before making measurements. |
| 8485D | Prior to calibration, a Keysight 11708A 30 dB reference attenuator and an APC 3.5 (f) to 50 Ω (m) N-Type adapter (08485-60005) should be connected between the power sensor and the POWER REF. Remove this attenuator and adaptor before making measurements. |
| 8487A | This sensor requires an APC 2.4 (f) to 50 Ω (m) N-Type adapter (08487-60001) to connect to the POWER REF. Remove this adapter before making measurements. |
| 8487D | Prior to calibration, a Keysight 11708A 30 dB reference attenuator and an APC 2.4 (f) to 50 Ω (m) N-Type adapter (08487-60001) should be connected between the power sensor and the POWER REF. Remove this adapter before making measurements. |

Measurement Accuracy

Power sensors have small errors in their response over frequency. The response of each sensor is measured during manufacture (and during periodic calibration) and the resulting frequency compensation information is supplied in the form of calibration factors. Using calibration factors enables you to achieve improved measurement accuracy. The EPM Series power meters provide two methods of using the calibration factors:

- inputting the individual calibration factor for a frequency prior to making the measurement, or
- using sensor calibration tables.

If you are making most of your measurements at a single frequency, or in a narrow range of frequencies, entering a specific calibration factor is a more effective method. Only a minimal amount of data entry is required.

However, if you are making measurements on a wide range of signal frequencies, a sensor table is more effective as you only need to enter the frequency of the signal you are measuring. The power meter automatically selects and applies the calibration factor from the selected table.

Frequency Specific Calibration Factors

This section shows you how to make a measurement using the calibration factor for the frequency of the signal you want to measure.

Tip This method is best suited to making several measurements at one frequency as you need only enter a small amount of data. Using this method requires the following steps:

- 1 Zero and calibrate the power meter/sensor combination.
- 2 Set the calibration factor value for the frequency of the signal you want to measure.
- 3 Make the measurement.

Procedure

First, select and enter the reference calibration factor for the desired sensor as follows:

- 1 Ensure the power sensor is disconnected from any signal source.
- 2 Refer to the connection requirements in [Table 5-1](#) and ensure the sensor is ready for connection to the Power Reference.
- 3 Check the current reference calibration factor setting by pressing



, **1 of 2**, and **REF CFs**. The value is displayed under the channel **Ref CF** softkey.

NOTE

Does this setting match the value for the sensor? (The power sensor reference calibration factor can normally be found above the calibration factors table on the power sensor body.)

- 4 To change the settings, press the channel **REF CF**. The reference calibration factor pop up window is displayed as shown in [Figure 5-3](#). Use the numeric keypad to enter the required value in the **Ref Cal Factor** pop-up menu.

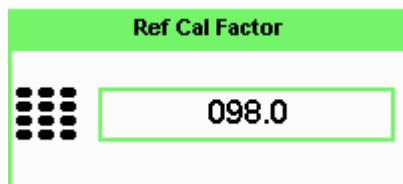

Figure 5-3 Reference Calibration Factor pop-up window

5 Press **%** to complete the entry.

Now, zero and calibrate the power meter/sensor combination as follows:

6 Press **Cal** and the channel **Zero** softkey. The **Zeroing** pop-up is displayed.

7 Connect the power sensor to the POWER REF output.

8 Press **Cal** and the channel **Cal** softkey to start the calibration routine. The **Calibrating** pop-up is then displayed.

NOTE

You can reduce the steps required to carry out the zero and calibration procedure as follows:

- Connect the power sensor to the POWER REF output.



- Press **Cal** and **Zero + Cal**. (For dual channel meters, press **Zero + Cal**, **Zero + Cal A** or **Zero + Cal B** as required).

Now, set the sensor calibration factor for the frequency of the signal you want to measure.

9 Check the current reference calibration factor setting by pressing **Channel**, **Offset**. The value is displayed on the **Cal Fac** field.

NOTE

Does this setting match the value for the sensor? (The power sensor reference calibration factor can normally be found above the calibration factors table on the power sensor body.)

- 10 To change the settings, use the  and  keys to highlight the **Cal Fac** value field and press  to display the **Cal Factor** pop-up. Use the numeric keypad to enter the required value in the **Cal Factor** pop-up window.

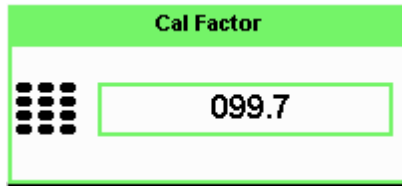



Figure 5-4 Calibration factor pop-up window

- 11 Press  to complete the entry.
- 12 Connect the power sensor to the signal to be measured.
- 13 The corrected measurement result is displayed.

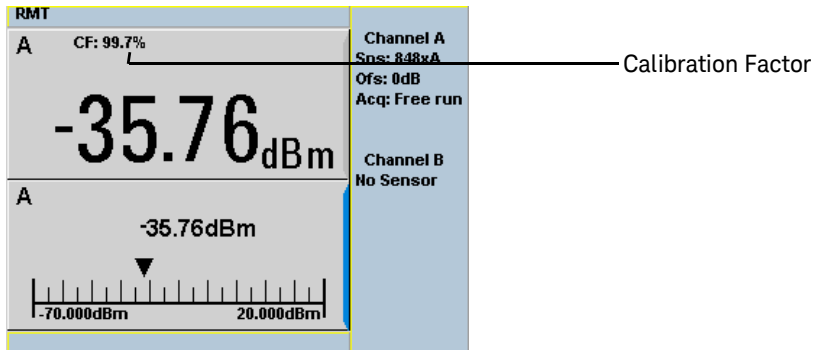









Figure 5-5 Calibration factor display

Example

To make a measurement on channel A with a power sensor which has a reference calibration factor of 99.8% and a calibration factor of 97.6% at the measurement frequency.

- 1 Disconnect the power sensor from any signal source.
- 2 Press , **REF CFs** and the channel **REF CF** softkey.
- 3 Use the numeric keypad to enter 99.8 in the **Ref Cal Factor** pop-up window.
- 4 Press **%** to complete the entry.
- 5 Press  and the channel **Zero** softkey. The **Zeroing** pop-up is displayed.
- 6 Connect the power sensor to the POWER REF output.
- 7 Press  and the channel **Cal** softkey to start the calibration routine. The **Calibrating** pop-up is then displayed.
- 8 Press , **Offset**. The value is displayed on the **Cal Fac** field.
- 9 Use the  and  keys to highlight the **Cal Fac** value field and press  to display the **Cal Factor** pop-up. Use the numeric keypad to enter 97.6 in the **Cal Factor** pop-up window.
- 10 Press **%** to complete the entry.
- 11 Connect the power sensor to the signal to be measured.
- 12 The corrected measurement result is displayed.

NOTE

When no sensor tables are selected and **Single Numeric** display mode is chosen, the calibration factor used for the measurement is displayed in the upper window as shown in [Figure 5-5](#).

Sensor Calibration Tables

This section describes how to use sensor calibration tables. Sensor calibration tables store the measurement calibration factors, for a power sensor model or for a specific power sensor, in the power meter. They are used to correct measurement results.

Use sensor calibration tables when you want to make power measurements over a range of frequencies using one or more power sensors.



The N1913/1914A EPM Series power meters are capable of storing 20 sensor calibration tables each containing up to 80 frequency points. The power meter is supplied with a set of 9 predefined sensor calibration tables plus a “100%” default table. The data in these tables is based on statistical averages for a range of Keysight Technologies power sensors. Your own sensor will most likely differ from the typical to some degree. If you require best accuracy, create a custom table for each sensor you use as shown in [“Editing/Generating Sensor Calibration Tables”](#) on page 166.

To use calibration factor tables:

- 1** Select the sensor calibration table to be applied to a channel.
- 2** Zero and calibrate the power meter. The reference calibration factor used during the calibration is automatically set by the power meter from the sensor calibration table.
- 3** Specify the frequency of the signal you want to measure. The calibration factor is automatically set by the power meter from the sensor calibration table.
- 4** Make the measurement.

Procedure

First select the table for the sensor you are using as follows:

- 1 Press , **Tables**, **Sensor Cal Tables**.
- 2 Use the  and  keys to highlight one of the 20 table titles and press **Table** to highlight **On**.

| RMT | | | Sensor Tbls |
|------------------|-------|-----|-------------------|
| Tbl Name | State | Pts | |
| 0 DEFAULT | off | 2 | Edit Table |
| 1 8481A | off | 19 | A Table Off On |
| 2 8482A | off | 12 | |
| 3 8483A | off | 10 | B Table Off On |
| 4 8481D | off | 21 | |
| 5 8485A | off | 22 | Done |
| 6 R8486A | off | 17 | |
| 7 Q8486A | off | 19 | 1 of 1 |
| 8 R8486D | off | 17 | |
| 9 8487A | off | 54 | |

Figure 5-6 Sensor table selected

NOTE

When no data is contained in the highlighted table, the **Table** key is disabled (grayed out).

- 3 Press **Done** to complete the selection of the calibration factor table. [Figure 5-7](#) shows which offset table is selected.

| RMT | | Tables |
|------------|----------------|-------------------|
| A | 50.0MHz (5) | Sensor Cal Tables |
| -36.68 dBm | | Freq. Dep. Offset |

Sensor Table 5 Selected

Figure 5-7 Frequency dependent offset indicator

- 4 To change the frequency, press  and use the  and  keys to highlight the **Frequency** field.

- 5 Press  to display the **Frequency** pop-up window. Use the numeric keypad to enter the required value in the **Frequency** pop-up window.
- 6 To confirm your choice, press the appropriate unit softkey.
- 7 Connect the power sensor to the signal to be measured.
- 8 The corrected measurement result is now displayed.

NOTE

If the measurement frequency does not correspond directly to a frequency in the sensor calibration table, the power meter calculates the calibration factor using linear interpolation.

If you enter a frequency outside the frequency range defined in the sensor calibration table, the power meter uses the highest or lowest frequency point in the sensor calibration table to set the calibration factor.

NOTE

When **Single Numeric** display mode is chosen, the frequency you entered and the sensor table identifier is displayed in the upper window. Also, pressing



, **Offset** displays the frequency you entered and calibration factor for each channel derived from the selected sensor tables.

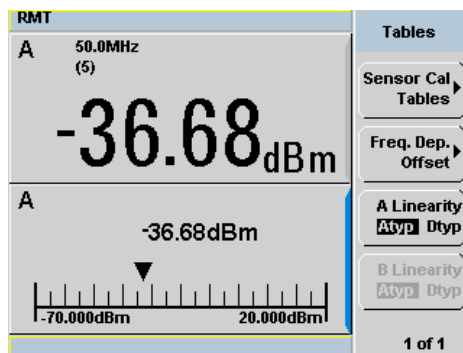

Figure 5-8 Frequency/calibration table display

Editing/Generating Sensor Calibration Tables

To help achieve the best accuracy in your measurement you can enter the values supplied for the sensors you are using by editing the installed sensor calibration tables or by generating your own custom tables.

You cannot delete any of the 20 existing calibration tables or create any additional tables. However, you can edit or delete the content of each table. If you need another table you should edit and rename one of the tables. Each calibration table can contain a maximum of 80 frequency points.

To view the calibration tables currently stored in the power meter, press , **Tables**, **Sensor Cal Tables**. The **Sensor Tbls** screen is displayed as shown in [Figure 5-6](#).

Table 5-2 Installed power sensor models

| Table | Sensor Model | Table | Sensor Model |
|-------|------------------------|-------|--------------|
| 0 | DEFAULT ^[a] | 5 | 8485A |
| 1 | 8481A | 6 | R8486A |
| 2 | 8482A ^[b] | 7 | Q8486A |
| 3 | 8483A | 8 | R8486D |
| 4 | 8481D | 9 | 8487A |

[a] DEFAULT is a sensor calibration table where the reference calibration factor and calibration factors are 100%. This sensor calibration table can be used during the performance testing of the power meter.

[b] The 8482B and 8482H power sensors use the same data as the 8482A.

There are also ten sensor calibration tables named **CUSTOM_0** through **CUSTOM_9**. These tables do not contain any data when the power meter is shipped from the factory.

Editing frequency dependent offset tables requires the following steps:

- 1 Identify and select the table you want to edit.
- 2 Rename the table.
- 3 Enter the frequency and offset pairs.
- 4 Save the table.



Procedure

First select the table you want to edit as follows:

- 1 Press , **Tables**, **Sensor Cal Tables** to display the **Sensor Tbls** screen.

| RMT | | | Sensor Tbls | |
|------------------|-------|-----|-------------|--|
| Tbl Name | State | Pts | | |
| 0 DEFAULT | off | 2 | Edit Table | |
| 1 8481A | off | 19 | A Table | |
| 2 8482A | off | 12 | Off On | |
| 3 8483A | off | 10 | B Table | |
| 4 8481D | off | 21 | Off On | |
| 5 8485A | off | 22 | Done | |
| 6 R8486A | off | 17 | | |
| 7 Q8486A | off | 19 | | |
| 8 R8486D | off | 17 | | |
| 9 8487A | off | 54 | | |
| | | | 1 of 1 | |

Figure 5-9 “Sensor Tbls” screen

- 2 Choose the table you want to edit using the  and  keys. Press **Edit Table** to display the **Edit Cal** screen as shown in [Figure 5-10](#).

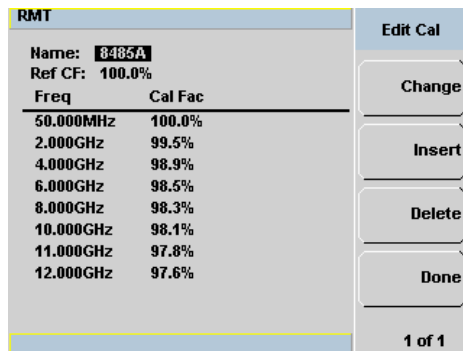

Figure 5-10 “Edit Cal” display

- 3 Highlight the table title using the and keys. Press **Change** and use the , , and keys to select and change the characters in the **Table Name** pop-up to create the name you want to use.

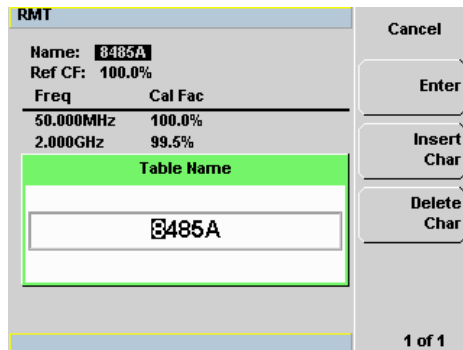

Figure 5-11 Edit table title pop-up

- Pressing **Insert Char** adds a new character to the right of the selected character.
 - Pressing **Delete Char** removes the selected character.
- 4 Press **Enter** to complete the entry.

NOTE

A calibration factor in the range of 1% to 150% can be entered.

The following rules apply to naming sensor calibration tables:

- The name must consist of no more than 12 characters.
 - All characters must be upper or lower case alphabetic characters, or numeric (0-9), or an underscore (_).
 - No other characters are allowed.
 - No spaces are allowed in the name.
-

Enter (or edit) the frequency and cal factor pairs as follows:

- 1 Press **Insert** to add a new frequency value (or press **Change** to edit). Use the numeric keypad to enter the required value in the **Frequency** pop-up window. Complete the entry by pressing the **GHz**, **MHz** keys.
- 2 Enter the new cal factor value (or press **Change** to edit). Use the numeric keypad to enter the required value in the **Cal Factor** pop-up window. Complete the entry by pressing the **%** key.
- 3 Continue adding or editing values until you have entered all the data you require.
- 4 When you have finished editing the table, press **Done** to save the table.

NOTE

Ensure that the frequency points you use cover the frequency range of the signals you want to measure. If you measure a signal with a frequency outside the frequency range defined in the sensor calibration table, the power meter uses the highest or lowest frequency point in the sensor calibration table to calculate the offset

Pre-installed Calibration Table Contents

The following lists detail the contents of the installed sensor calibration tables.

| DEFAULT | |
|-----------------------|------|
| RCF | 100 |
| 0.1 MHz | 100 |
| 110 GHz | 100 |
| Keysight 8481A | |
| RCF | 100 |
| 50 MHz | 100 |
| 100 MHz | 99.8 |
| 2 GHz | 99 |
| 3 GHz | 98.6 |
| 4 GHz | 98 |
| 5 GHz | 97.7 |
| 6 GHz | 97.4 |
| 7 GHz | 97.1 |
| 8 GHz | 96.6 |
| 9 GHz | 96.2 |
| 10 GHz | 95.4 |
| 11 GHz | 94.9 |
| 12.4 GHz | 94.3 |
| 13 GHz | 94.3 |
| 14 GHz | 93.2 |
| 15 GHz | 93 |
| 16 GHz | 93 |
| 17 GHz | 92.7 |
| 18 GHz | 91.8 |
| Keysight 8482A | |
| RCF | 98 |

| Keysight 8483A | |
|-----------------------|------|
| RCF | 94.6 |
| 0.1 MHz | 94 |
| 0.3 MHz | 97.9 |
| 1 MHz | 98.4 |
| 3 MHz | 98.4 |
| 10 MHz | 99.3 |
| 30 MHz | 98.7 |
| 100 MHz | 97.8 |
| 300 MHz | 97.5 |
| 1 GHz | 97.2 |
| 2 GHz | 96.4 |
| 3 GHz | 93 |
| 4 GHz | 91 |
| Keysight 8481D | |
| RCF | 99 |
| 50 MHz | 99 |
| 500 MHz | 99.5 |
| 1 GHz | 99.4 |
| 2 GHz | 99.5 |
| 3 GHz | 98.6 |
| 4 GHz | 98.6 |
| 5 GHz | 98.5 |
| 6 GHz | 98.5 |
| 7 GHz | 98.6 |
| 8 GHz | 98.7 |
| 9 GHz | 99.5 |

| | |
|---------|------|
| 0.1 MHz | 98 |
| 0.3 MHz | 99.5 |
| 1 MHz | 99.3 |
| 3 MHz | 98.5 |
| 10 MHz | 98.5 |
| 30 MHz | 98.1 |
| 100 MHz | 97.6 |
| 300 MHz | 97.5 |
| 1 GHz | 97 |
| 2 GHz | 95 |
| 3 GHz | 93 |
| 4.2 GHz | 91 |

Keysight R8486A

| | |
|----------|------|
| RCF | 100 |
| 50 MHz | 100 |
| 26.5 GHz | 94.9 |
| 27 GHz | 94.9 |
| 28 GHz | 95.4 |
| 29 GHz | 94.3 |
| 30 GHz | 94.1 |
| 31 GHz | 93.5 |
| 32 GHz | 93.7 |
| 33 GHz | 93.7 |
| 34 GHz | 94.9 |
| 34.5 GHz | 94.5 |
| 35 GHz | 94.4 |
| 36 GHz | 93.7 |

| | |
|----------|-------|
| 10 GHz | 98.6 |
| 11 GHz | 98.7 |
| 12 GHz | 99 |
| 12.4 GHz | 99.1 |
| 13 GHz | 98.9 |
| 14 GHz | 99.4 |
| 15 GHz | 98.9 |
| 16 GHz | 99.1 |
| 17 GHz | 98.4 |
| 18 GHz | 100.1 |

Keysight N8485A continued

| | |
|------------------------|------|
| 17 GHz | 96.7 |
| 18 GHz | 96.6 |
| 19 GHz | 96 |
| 20 GHz | 96.1 |
| 21 GHz | 96.2 |
| 22 GHz | 95.3 |
| 23 GHz | 94.9 |
| 24 GHz | 94.3 |
| 25 GHz | 92.4 |
| 26 GHz | 92.2 |
| 26.5 GHz | 92.1 |
| Keysight R8486D | |
| RCF | 97.6 |
| 50 MHz | 97.6 |

5 Using 8480 Series Power Sensors

| | |
|-----------------------|------|
| 37 GHz | 94.9 |
| 38 GHz | 93.5 |
| 39 GHz | 93.9 |
| 40 GHz | 92.3 |
| Keysight 8485A | |
| RCF | 100 |
| 50 MHz | 100 |
| 2 GHz | 99.5 |
| 4 GHz | 98.9 |
| 6 GHz | 98.5 |
| 8 GHz | 98.3 |
| 10 GHz | 98.1 |
| 11 GHz | 97.8 |
| 12 GHz | 97.6 |
| 12.4 GHz | 97.6 |
| 14 GHz | 97.4 |
| 16 GHz | 97 |

| | |
|----------|------|
| 26.5 GHz | 97.1 |
| 27 GHz | 95.3 |
| 28 GHz | 94.2 |
| 29 GHz | 94.5 |
| 30 GHz | 96.6 |
| 31 GHz | 97.6 |
| 32 GHz | 98 |
| 33 GHz | 98.9 |
| 34 GHz | 99.5 |
| 34.5 GHz | 99 |
| 35 GHz | 97.6 |
| 36 GHz | 99 |
| 37 GHz | 98.2 |
| 38 GHz | 97.4 |
| 39 GHz | 97.6 |
| 40 GHz | 100 |

| Keysight 8487A | |
|-----------------------|------|
| RCF | 100 |
| 50 MHz | 100 |
| 100 MHz | 99.9 |
| 500 MHz | 98.6 |
| 1 GHz | 99.8 |
| 2 GHz | 99.5 |
| 3 GHz | 98.9 |
| 4 GHz | 98.8 |
| 5 GHz | 98.6 |
| 6 GHz | 98.5 |
| 7 GHz | 98.4 |
| 8 GHz | 98.3 |
| 9 GHz | 98.3 |
| 10 GHz | 98.3 |
| 11 GHz | 98.1 |
| 12 GHz | 97.9 |
| 13 GHz | 98 |
| 14 GHz | 98.2 |
| 15 GHz | 97.7 |
| 16 GHz | 96.8 |
| 17 GHz | 97 |
| 18 GHz | 96.3 |
| 19 GHz | 95.9 |
| 20 GHz | 95.2 |
| 21 GHz | 95.6 |
| 22 GHz | 95.5 |

| Keysight 8487A continued | |
|---------------------------------|------|
| 34.5 GHz | 93.5 |
| 35 GHz | 93.1 |
| 36 GHz | 92 |
| 37 GHz | 92.4 |
| 38 GHz | 90.9 |
| 39 GHz | 91.3 |
| 40 GHz | 91.4 |
| 41 GHz | 90.6 |
| 42 GHz | 89.9 |
| 43 GHz | 89.1 |
| 44 GHz | 88.1 |
| 45 GHz | 86.9 |
| 46 GHz | 85.8 |
| 47 GHz | 85.4 |
| 48 GHz | 83.2 |
| 49 GHz | 81.6 |
| 50 GHz | 80.2 |
| Keysight Q8486A | |
| RCF | 100 |
| 50 MHz | 100 |
| 33.5 GHz | 91.3 |
| 34.5 GHz | 92 |
| 35 GHz | 91.7 |
| 36 GHz | 91.5 |
| 37 GHz | 92.1 |
| 38 GHz | 91.7 |

5 Using 8480 Series Power Sensors

| | |
|--------|------|
| 23 GHz | 95.4 |
| 24 GHz | 95 |
| 25 GHz | 95.4 |
| 26 GHz | 95.2 |
| 27 GHz | 95.1 |
| 28 GHz | 95 |
| 29 GHz | 94.4 |
| 30 GHz | 94 |
| 31 GHz | 93.7 |
| 32 GHz | 93.8 |
| 33 GHz | 93 |
| 34 GHz | 93.2 |

| | |
|--------|------|
| 39 GHz | 91 |
| 40 GHz | 90.7 |
| 41 GHz | 90.3 |
| 42 GHz | 89.5 |
| 43 GHz | 88.5 |
| 44 GHz | 88.7 |
| 45 GHz | 88.2 |
| 46 GHz | 87 |
| 47 GHz | 86.4 |
| 48 GHz | 85.3 |
| 49 GHz | 84.7 |
| 50 GHz | 82.9 |

6 Using N8480 Series Power Sensors

| | |
|---|-----|
| Introduction | 176 |
| Power Meter Configuration Changes | 177 |
| Default Channel Setup | 178 |
| N8480 Series Sensors Connection Requirements | 179 |
| N8480 Series Power Sensors (excluding Option CFT) | 180 |
| N8480 Series Power Sensors with Option CFT | 182 |

This chapter describes how to use your N8480 Series power sensors with N1913/1914A EPM Series power meters.

Introduction

The N8480 Series power sensors are replacement for the 8480 Series power sensors (excluding the D-model sensors) with build-in **E**lectrically **E**rasable **P**rogrammable **R**ead-Only **M**emory (EEPROM)^[1].

The N8480 Series power sensors are used for measuring the average power supplied by RF or microwave source or a device-under-test (DUT). The N8480 Series power sensors place a 50 Ω load on the RF or microwave source. The power meter indicates the power dissipated in this load in W or dBm.

The N8480 sensors (excluding Option CFT) measure power levels from –35 dBm to +20 dBm (316 nW to 100 mW), at frequencies from 10 MHz to 33 GHz and have two independent power measurement path (upper and lower range).

Table 6-1 Power range in the Range setting

| Sensor | Range Setting | Lower Range | Upper Range |
|--|----------------------|-------------------|--------------------|
| N8481/2/5/7/8A excluding Option CFT | AUTO (Default) | –35 dBm to –1 dBm | –1 dBm to +20 dBm |
| | LOWER | –35 dBm to –1 dBm | - |
| | UPPER ^[a] | - | –30 dBm to +20 dBm |

[a] Recommended for pulse signals measurement with period of more than one second.

Meanwhile, the N8480 sensors with Option CFT only measure power levels from –30 dBm to +20 dBm (1 μ W to 100 mW) in single range.

Similar to the E-Series power sensors, the N8480 Series power sensors are also equipped with EEPROM to store sensor's characteristics such as model number, serial number, linearity, temperature compensation, calibration factor^[1] and so forth. However, the calibration factor table stored in EEPROM is not applicable for N8480 Series power sensors with Option CFT, and require that you use default calibration tables or manually enter the required correction factors. Likewise, they cannot be used to make peak or time gated measurements.

Please refer to the documentation supplied with your Keysight N8480 Series power sensors for specification and calibration information.

[1] The calibration factor table stored in the EEPROM is not applicable for N8480 Series sensors with Option CFT.

Power Meter Configuration Changes

The N1913/1914A EPM Series power meter recognizes when a N8480 Series power sensor is connected. The N8480 Series power sensors' (excluding Option CFT) calibration data is automatically read by the power meter. In addition, the auto-averaging settings shown in [Figure 6-1](#) are automatically configured.

| | N8481/2/5A | Maximum Sensor Power | Resolution Setting | | | |
|--|------------|-------------------------|--------------------|----|-----|-----|
| | | | 1 | 2 | 3 | 4 |
| | 0 dBm | ----- | 1 | 1 | 2 | 8 |
| | -1 dBm | | 2 | 2 | 4 | 32 |
| | -10 dBm | ----- | 2 | 2 | 4 | 32 |
| | -20 dBm | ----- | 2 | 2 | 16 | 256 |
| | -30 dBm | ----- | 2 | 8 | 128 | 128 |
| | | ----- | 4 | 64 | 256 | 512 |
| | | Minimum Sensor Power | | | | |

Figure 6-1 Auto-averaging settings

NOTE

These values are valid only for the power meter channel connected to a N8480 Series power sensor. Averaging settings can also be manually configured. Refer to [“Setting Measurement Averaging”](#) on page 73 for more details.

Default Channel Setup

When a N8480 Series power sensor is connected, the following Channel Setup is automatically configured. Presetting returns the channel to this configuration.

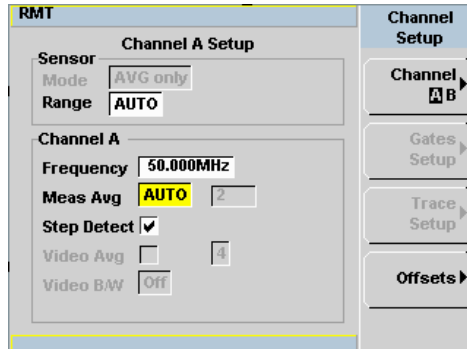

Figure 6-2 N8480 Series sensor (excluding Option CFT) default channel setup

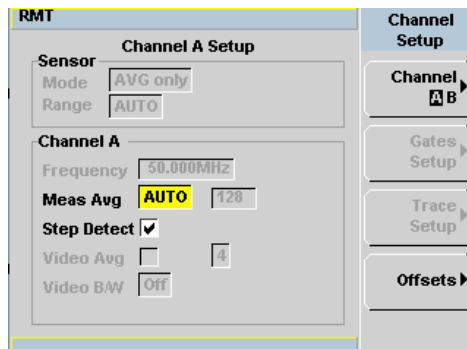

Figure 6-3 N8480 Series sensor with Option CFT default channel setup

N8480 Series Sensors Connection Requirements

Table 6-2 N8480 Series connection requirements

| Sensor | Connection Requirements |
|--------------------------------|--|
| N8481A N8482A | These power sensors connect directly to the POWER REF. |
| N8485A | This power sensor requires an APC 3.5 (f) to 50 Ω (m) N-Type adapter (08485-60005) to connect to the POWER REF. Remove this adapter before making measurements. |
| N8487A N8488A | This sensor requires an APC 2.4 (f) to 50 Ω (m) N-Type adapter (08487-60001) to connect to the POWER REF. Remove this adapter before making measurements. |

N8480 Series Power Sensors (excluding Option CFT)



Power sensors have small errors in their response over frequency. The response of each sensor is measured during manufacture (and during periodic calibration). With N8480 Series power sensors (excluding Option CFT), the resulting frequency compensation information is written into EEPROM. This allows the frequency and calibration data to be downloaded to the power meter automatically.

Using calibration factors enables you to achieve improved measurement accuracy. This section describes making continuous wave measurements using the N8480 Series power sensors (excluding Option CFT).

Making a measurement requires the following steps:

- 1 Zero and calibrate the power meter/sensor combination.
- 2 Set the frequency for the signal you want to measure.
- 3 Make the measurement.

Procedure





- 1 First, zero and calibrate the power meter/sensor combination.
- 2 Ensure the power sensor is disconnected from any signal source. Press  and the channel **Zero** softkey. The **Zeroing** pop-up is displayed.
- 3 Connect the power sensor to the POWER REF output. Press  and the channel **Cal** softkey to start the calibration routine. The **Calibrating** pop-up is then displayed.

NOTE

You can reduce the steps required to carry out the zero and calibration procedure as follows:

- Connect the power sensor to the POWER REF output.
- Press  and **Zero + Cal** . (For dual channel meters, press **Zero + Cal** , **Zero + Cal A** or **Zero + Cal B** as required).

Now, set the frequency of the signal you want to measure. The power meter automatically selects the appropriate calibration factor.

- 4 Press . On dual channel meters, select the required channel.
- 5 Use the  and  keys to highlight the **Frequency** value field and press  to display the **Frequency** pop-up. Use the numeric keypad to enter the required value in the **Frequency** pop-up window.

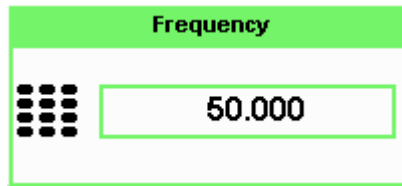



Figure 6-4 Frequency pop-up

- 6 Confirm your choice by pressing **MHz** or **GHz**.
- 7 Press  key to close the **Channel Setup** screen. Proceed to make the measurement.
- 8 Connect the power sensor to the signal to be measured. The corrected measurement result is displayed.

N8480 Series Power Sensors with Option CFT

Power sensors have small errors in their response over frequency. The response of each sensor is measured during manufacture (and during periodic calibration). The calibration factor table written into EEPROM is not applicable for N8480 Series power sensors with Option CFT. Therefore, the response of each sensor is measured during manufacture (and during periodic calibration) and the resulting frequency compensation information is supplied in the form of calibration factors. The EPM Series power meters provide two methods of using the calibration factors:

- inputting the individual calibration factor for a frequency prior to making the measurement, or
- using sensor calibration tables.

If you are making most of your measurements at a single frequency, or in a narrow range of frequencies, entering a specific calibration factor is a more effective method. Only a minimal amount of data entry is required.

However, if you are making measurements on a wide range of signal frequencies, a sensor table is more effective as you only need to enter the frequency of the signal you are measuring. The power meter automatically selects and applies the calibration factor from the selected table.

Frequency Specific Calibration Factors

This section shows you how to make a measurement using the calibration factor for the frequency of the signal you want to measure.

Tip This method is best suited to making several measurements at one frequency as you need only enter a small amount of data.

Using this method requires the following steps:

- 1** Zero and calibrate the power meter/sensor combination.
- 2** Set the calibration factor value for the frequency of the signal you want to measure.
- 3** Proceed to make the measurement.

Procedure

- 1 Ensure that the power sensor is disconnected from any signal source.
- 2 Refer to the connection requirements in [Table 6-2](#) and ensure that the sensor is ready for connection to the POWER REF.
- 3 Check the current reference calibration factor setting by pressing , **1 of 2**, **REF CFs**. The value is displayed under the channel **Ref CF** softkey.

Does this setting match the value for the sensor? (The power sensor reference calibration factor can normally be found above the calibration factors table on the power sensor body.)

- 4 To change the settings, press the channel **REF CF**. The reference calibration factor pop up window is displayed as shown in [Figure 6-5](#). Use the numeric keypad to enter the required value in the **Ref Cal Factor** pop-up menu.

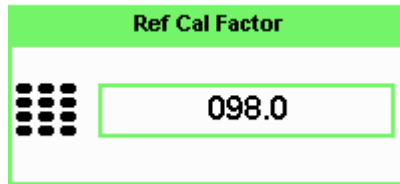



Figure 6-5 Reference calibration factor pop-up window

- 5 Press **%** to complete the entry.

Now, zero and calibrate the power meter/sensor combination as follows:

- 6 Press  and the channel **Zero** softkey. The **Zeroing** pop-up is displayed.
- 7 Connect the power sensor to the POWER REF output.
- 8 Press  and the channel **Cal** softkey to start the calibration routine. The **Calibrating** pop-up is then displayed.

NOTE

You can reduce the steps required to carry out the zero and calibration procedure as follows:

- Connect the power sensor to the POWER REF output.
- Press  and **Zero + Cal** . (For dual channel meters, press **Zero + Cal** , **Zero + Cal A** or **Zero + Cal B** as required).



Now, set the sensor calibration factor for the frequency of the signal to measure.

- 9 Check the current reference calibration factor setting by pressing  , **Offset** . The value is displayed on the **Cal Fac** field.

NOTE

Does this setting match the value for the sensor?

The power sensor reference calibration factor can normally be found above the calibration factors table on the power sensor body.

- 10 To change the settings, use the  and  keys to highlight the **Cal Fac** value field and press  to display the **Cal Factor** pop-up. Use the numeric keypad to enter the required value in the **Cal Factor** pop-up window.

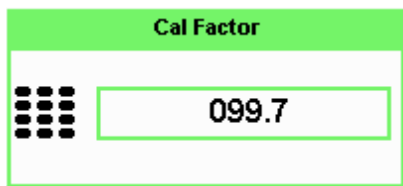

Figure 6-6 Calibration factor pop-up window

- 11 Press **%** to complete the entry.
- 12 Connect the power sensor to the signal to be measured.
- 13 The corrected measurement result is displayed.

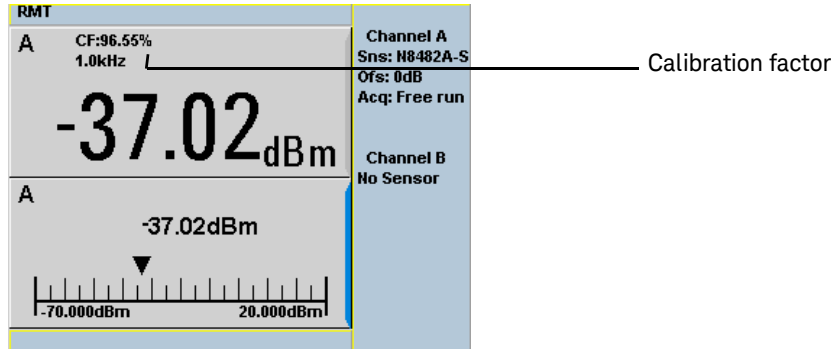







Figure 6-7 Calibration factor displayed

Example

To make a measurement on channel A with a power sensor which has a reference calibration factor of 99.8% and a calibration factor of 97.6% at the measurement frequency.

- 1 Disconnect the power sensor from any signal source.
- 2 Press **Cal**, **REF CFs** and the channel **REF CF** softkey.
- 3 Use the numeric keypad to enter 99.8 in the **Ref Cal Factor** pop-up window.
- 4 Press **%** to complete the entry.
- 5 Press **Cal** and the channel **Zero** softkey. The **Zeroing** pop-up is displayed.

- 6 Connect the power sensor to the POWER REF output.
- 7 Press  and the channel **Cal** softkey to start the calibration routine. The **Calibrating** pop-up is then displayed.
- 8 Press , **Offset**. The value is displayed on the **Cal Fac** field.
- 9 Use the  and  keys to highlight the **Cal Fac** value field and press  to display the **Cal Factor** pop-up. Use the numeric keypad to enter 97.6 in the **Cal Factor** pop-up window.
- 10 Press **%** to complete the entry.
- 11 Connect the power sensor to the signal to be measured.
- 12 The corrected measurement result is displayed.

NOTE

When no sensor tables are selected and **Single Numeric** display mode is chosen, the calibration factor used for the measurement is displayed in the upper window as shown in [Figure 6-7](#).

Sensor Calibration Tables

This section describes how to use sensor calibration tables. Sensor calibration tables store the measurement calibration factors, for a power sensor model or for a specific power sensor, in the power meter. They are used to correct measurement results.

Use sensor calibration tables when you want to make power measurements over a range of frequencies using one or more power sensors.

The N1913/1914A EPM Series power meters are capable of storing 20 sensor calibration tables, each containing up to 80 frequency points. The power meter is supplied with a set of nine predefined sensor calibration tables plus a “100%” default table. The data in these tables is based on statistical averages for a range of Keysight Technologies power sensors. Your own sensor will most likely differ from the typical to some degree. If you require best accuracy, create a custom table for each sensor you use as shown in [“Editing/Generating Sensor Calibration Tables”](#) on page 191.

To use calibration factor tables,





- 1** Select the sensor calibration table to be applied to a channel.
- 2** Zero and calibrate the power meter. The reference calibration factor used during the calibration is automatically set by the power meter from the sensor calibration table.
- 3** Specify the frequency of the signal you want to measure. The calibration factor is automatically set by the power meter from the sensor calibration table.
- 4** Make the measurement.

Selecting a Sensor Calibration Table

You can select a calibration factor table from the  key menu followed by **Tables** and **Sensor Cal Table**.



The State column indicates if any calibration factor tables are currently selected. The **Sensor Tbls** screen is shown in [Figure 6-8](#).

NOTE

You can also view which sensor table is being used by pressing the , **Offset** and use the  and  keys to highlight the **CF Table** setting field and press  to display the table.

Procedure

Select sensor calibration table as follows:

- 1 Press , **Tables**, **Sensor Cal Tables**.
- 2 Use the  and  keys to highlight one of the 20 table titles and press **Table** to highlight **On**.

| RMT | | | | Sensor Tbls | |
|------------------|-------|-----|--|-------------|-----------|
| Tbl Name | State | Pts | | | |
| 0 DEFAULT | A | 2 | | Edit | |
| 1 8481A | off | 19 | | Table | |
| 2 8482A | off | 12 | | A Table | |
| 3 8483A | off | 10 | | Off | On |
| 4 8481D | off | 21 | | B Table | |
| 5 8485A | off | 22 | | Off | On |
| 6 R8486A | off | 17 | | Done | |
| 7 Q8486A | off | 19 | | | |
| 8 R8486D | off | 17 | | | |
| 9 8487A | off | 54 | | | |

1 of 1

Figure 6-8 Sensor table selected

NOTE

When no data is contained in the highlighted table, the **Table** key is disabled (grayed out).

- 3 Press **Done** to complete the selection of the calibration factor table.
- 4 Press **Done** again to display the measurement screen. Figure 6-9 shows which offset table is selected.

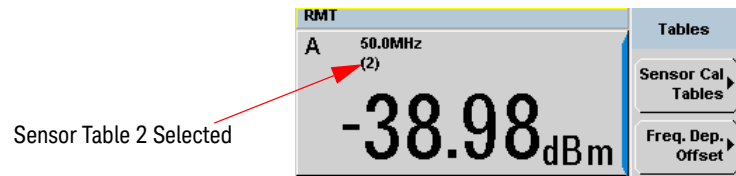



Figure 6-9 Frequency dependent offset indicator

- 5 To change the frequency, press **Channel** and use the  and  keys to highlight the **Frequency** field.
- 6 Press **Select** to display the **Frequency** pop-up window. Use the numeric keypad to enter the required value in the **Frequency** pop-up window.
- 7 To confirm your choice, press the appropriate unit softkey.
- 8 Connect the power sensor to the signal to be measured.
- 9 The corrected measurement result is now displayed.

NOTE

If the measurement frequency does not correspond directly to a frequency in the sensor calibration table, the power meter calculates the calibration factor using linear interpolation.

If you enter a frequency outside the frequency range defined in the sensor calibration table, the power meter uses the highest or lowest frequency point in the sensor calibration table to set the calibration factor.

NOTE

When **Single Numeric** display mode is chosen, the frequency you entered and the sensor table identifier is displayed in the upper window. Also, pressing



, **Offset** displays the frequency you entered and calibration factor for each channel derived from the selected sensor tables.

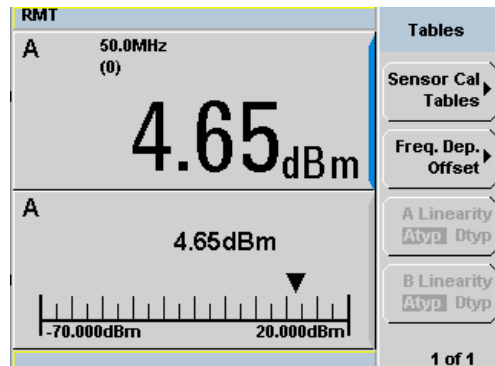

Figure 6-10 Frequency/calibration table display

Editing/Generating Sensor Calibration Tables

NOTE

Predefined sensor calibration factor table stored in power meter is not applicable for Keysight N8480 Series power sensors with Option CFT. Therefore, users are required to create a new sensor calibration table for the sensors when a sensor calibration table is needed.

To help achieve the best accuracy in your measurement you can enter the values supplied for the sensors you are using by editing the installed sensor calibration tables or by generating your own custom tables.

You cannot delete any of the 20 existing calibration tables or create any additional tables. However, you can edit or delete the content of each table. If you need another table you should edit and rename one of the tables. Each calibration table can contain a maximum of 80 frequency points.

To view the calibration tables currently stored in the power meter, press , **Tables**, **Sensor Cal Tables**. The **Sensor Tbls** screen is displayed as shown in [Figure 6-8](#).

Table 6-3 Installed power sensor models

| Table | Sensor Model | Table | Sensor Model |
|-------|------------------------|-------|--------------|
| 0 | DEFAULT ^[a] | 5 | 8485A |
| 1 | 8481A | 6 | R8486A |
| 2 | 8482A ^[b] | 7 | Q8486A |
| 3 | 8483A | 8 | R8486D |
| 4 | 8481D | 9 | 8487A |

[a] DEFAULT is a sensor calibration table where the reference calibration factor and calibration factors are 100%. This sensor calibration table can be used during the performance testing of the power meter.

[b] The 8482B and 8482H power sensors use the same data as the 8482A.

There are also ten sensor calibration tables named **CUSTOM_0** through **CUSTOM_9**. These tables do not contain any data when the power meter is shipped from the factory.

Editing frequency dependent offset tables requires the following steps:

- 1 Identify and select the table you want to edit
- 2 Rename the table
- 3 Enter the frequency and offset pairs
- 4 Save the table

Procedure



First, select the table you want to edit as follows:

- 1 Press , **Tables**, **Sensor Cal Tables** to display the **Sensor Tbls** screen.

| RMT | | | | Sensor Tbls |
|------------------|-------|-----|--------------------------|-------------|
| Tbl Name | State | Pts | | |
| 0 DEFAULT | A | 2 | Edit Table | |
| 1 8481A | off | 19 | A Table Off On | |
| 2 8482A | off | 12 | B Table Off On | |
| 3 8483A | off | 10 | Done | |
| 4 8481D | off | 21 | | |
| 5 8485A | off | 22 | | |
| 6 R8486A | off | 17 | | |
| 7 Q8486A | off | 19 | | |
| 8 R8486D | off | 17 | | |
| 9 8487A | off | 54 | | |







1 of 1

Figure 6-11 “Sensor Tbls” screen

- 2 Choose the table you want to edit using the  and  keys. Press **Edit Table** to display the **Edit Cal** screen as shown in [Figure 6-12](#).

| RMT | | Edit Cal |
|--------------------|---------|------------------------------------|
| Name: 8481A | | Change Insert Delete Done |
| Ref CF: 90.0% | | |
| Freq | Cal Fac | |
| 100.000MHz | 99.7% | |
| 2.000GHz | 98.0% | |
| 3.000GHz | 97.7% | |
| 4.000GHz | 97.4% | |
| 5.000GHz | 97.0% | |
| 6.000GHz | 96.9% | |
| 7.000GHz | 96.4% | |
| 8.000GHz | 96.0% | |
| | | 1 of 1 |

Figure 6-12 “Edit Cal” display

- 3 Highlight the table title using the  and  keys. Press **Change** and use the , ,  and  keys to select and change the characters in the Table Name pop-up to create the name you want to use.

| RMT | | Cancel |
|--|--------------|--------|
| Name: N8481A | | % |
| Ref CF: 90.0% | | |
| Freq | Cal Fac | |
| 100.000MHz | 99.7% | |
| 2.000GHz | 98.0% | |
| <div style="border: 2px solid green; padding: 5px;"> <p style="text-align: center; background-color: #90EE90; margin: 0;">Cal Factor</p> <div style="display: flex; align-items: center; gap: 10px;"> <div style="text-align: center;">  </div> <div style="border: 1px solid green; padding: 5px; text-align: center;">099.7</div> </div> </div> | | |
| | | 1 of 1 |

Figure 6-13 Edit table title pop-up

- Pressing **Insert Char** adds a new character to the right of the selected character.
 - Pressing **Delete Char** removes the selected character.
- 4 Press **Enter** to complete the entry.

NOTE

A calibration factor in the range of 1% to 150% can be entered.

The following rules apply to naming sensor calibration tables:

- The name must consist of no more than 12 characters.
 - All characters must be upper or lower case alphabetic characters, or numeric (0-9), or an underscore (_).
 - No other characters are allowed.
 - No spaces are allowed in the name.
-

Enter (or edit) the frequency and cal factor pairs as follows:

- 1** Press **Insert** to add a new frequency value (or press **Change** to edit). Use the numeric keypad to enter the required value in the **Frequency** pop-up window. Complete the entry by pressing the **GHz**, **MHz** keys.
- 2** Enter the new cal factor value (or press **Change** to edit). Use the numeric keypad to enter the required value in the **Cal Factor** pop-up window. Complete the entry by pressing the **%** key.
- 3** Continue adding or editing values until you have entered all the data you require.
- 4** When you have finished editing the table press **Done** to save the table.

NOTE

Ensure that the frequency points you use cover the frequency range of the signals you want to measure. If you measure a signal with a frequency outside the frequency range defined in the sensor calibration table, the power meter uses the highest or lowest frequency point in the sensor calibration table to calculate the offset

7 Using U2000 Series USB Power Sensors

| | |
|--|-----|
| Introduction | 196 |
| Power Meter Configuration | 197 |
| Measurement Accuracy | 200 |
| Electromagnetic Compatibility (EMC) Measurements | 202 |
| Measurement Accuracy and Speed | 203 |

This chapter describes how to use your U2000 Series USB power sensors with N1913/1914A EPM Series power meters

Introduction

The U8480 Series USB thermocouple sensors are true average, wide dynamic range RF microwave power sensors. They are based on a dual sensor diode pair/attenuator/diode pair.

This technique ensures the diodes in the selected signal path are kept in their square law region, thus the output current (and voltage) is proportional to the input power. The diode pair/attenuator/diode pair assembly can yield the average of complex modulation formats across a wide dynamic range, irrespective of signal bandwidth. The dual range Modified Barrier Integrated Diode (MBID)^[1] package includes further refinements to improve power handling allowing accurate measurement of high level signals with high crest factors without incurring damage^[2] to the sensor.

These sensors measure average RF power on a wide variety of modulated signals and are independent of the modulation bandwidth. They are ideally suited to the average power measurement of multi-tone and spread spectrum signals such as CDMA, W-CDMA and digital television formats.

Please refer to the documentation supplied with your U8480 Series USB thermocouple sensors for specification and calibration information.

NOTE

The U2000 Series power sensors with firmware revision of A1.02.01 and below are tested with the N1913A/N1914A EPM Series power meters.

[1] November 1986 Hewlett-Packard Journal pages 14-2, "Diode Integrated Circuits for Millimeter-Wave Applications.

[2] Refer to *U2000 Series Operating and Service Guide* for maximum power handling specifications.

Power Meter Configuration

The N1913/1914A EPM Series power meters automatically recognize an U2000 Series USB power sensor when it is connected. The sensor calibration data is automatically read by the power meter. The power meter also configures the auto-averaging settings shown in [Figure 7-1](#) to suit the power sensor characteristics.

NOTE

These values are valid only for the power meter channel connected with U8480 Series USB thermocouple sensors.

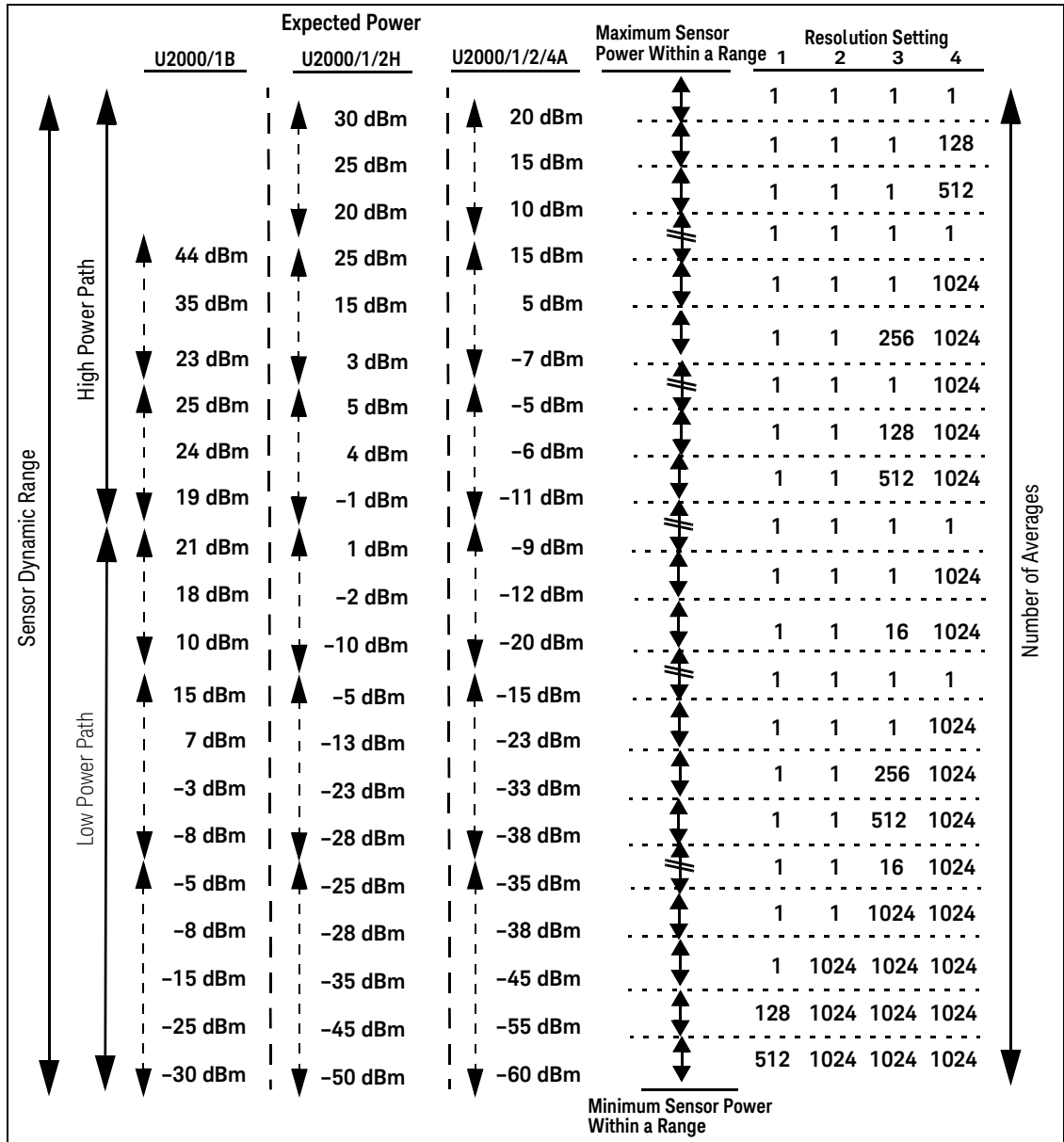

Figure 7-1 U2000 Series auto-averaging settings

Default Channel Setup

When an U2000 Series USB power sensor is connected, the following **Channel Setup** is automatically configured. Carrying out a Preset returns the power meter to this configuration.

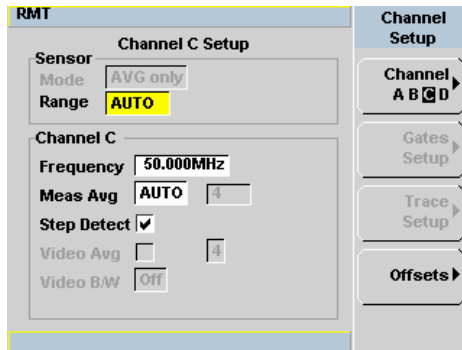

Figure 7-2 U2000 Series USB power sensor default channel setup

Measurement Accuracy

Power sensors have small errors in their response over frequency. The response of each sensor is measured during manufacture to determine correction factors. With U2000 Series USB power sensors, correction factors are stored in a 3 MB Flash memory and are downloaded to the power meter automatically. Ensure that the USB power sensor is zeroed. Calibration is not required as it is performed internally.

Using calibration factors enables improved measurement accuracy. This section describes making average power measurements using the U2000 Series USB power sensors.

Making a measurement requires the following steps:

- 1 Zero the power meter/power sensor combination.
- 2 Set the frequency for the signal you want to measure.
- 3 Make the measurement.





Table 7-1 Power sensor connection requirements

| Sensor | Connection Requirements |
|--|---|
| U2000A U2000H U2001A U2001H U2002A U2002H U2004A | These power sensors connect directly to the POWER REF when performing external zeroing. |
| U2000B U2001B | These power sensors are configured with an attenuator. Do not remove the attenuator when performing external zeroing. |

Procedure

- 1 Zero the power meter/power sensor combination.
- 2 Ensure the power sensor is disconnected from any signal source.
- 3 Press  and the channel **Zero** softkey. Select the required channel.

Now, set the frequency of the signal you want to measure. The power meter automatically selects the appropriate calibration factor.

- 4 Press . On dual channel meters select the required channel.
- 5 Use the  and  keys to highlight the **Frequency** value field and press  to display the **Frequency** pop-up. Use the numeric keypad to enter the required value in the **Frequency** pop-up window.

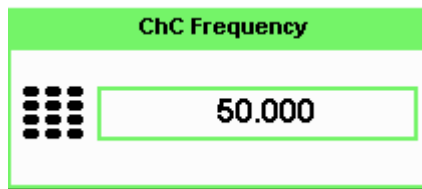



Figure 7-3 Frequency pop-up

- 6 Confirm your choice by pressing **MHz** or **GHz**.
- 7 Press  key to close the **Channel Setup** screen.
- 8 Proceed to make the measurement.
- 9 Reconnect any required attenuators or adaptors and connect the power sensor to the signal to be measured.

The corrected measurement result is displayed.

Electromagnetic Compatibility (EMC) Measurements

The low frequency range of the U2004A make it the ideal choice for making EMC measurements to CISPR (Comite International Special Perturbations Radioelectriques) requirements, and electromagnetic interference (EMI) test applications such as the radiated immunity test (IEC61000-4-3).

DC coupling of the U2004A input allows excellent low frequency coverage. However, the presence of any dc voltages mixed with the signal has an adverse effect on the accuracy of the power measurement.

CAUTION

The U2004A sensor is DC coupled. DC voltages in excess of the maximum value (5 VDC) can damage the sensing diode.

Measurement Accuracy and Speed

The power meter has no internal ranges. The only ranges you can set are those of the U8480 Series USB thermocouple sensors. With an U2000 Series power sensor the range can be set either automatically or manually. Use autoranging when you are unsure of the power level you are about to measure.

CAUTION

To prevent damage to your sensor do not exceed the power levels specified in the sensor user's guide. The U2004A sensor is DC coupled. DC voltages in excess of the maximum value (5 VDC) can damage the sensing diode.

Setting the Range

There are two manual settings, **LOWER** and **UPPER**. The **LOWER** range uses the more sensitive path and the **UPPER** range uses the attenuated path in the U8480 Series USB thermocouple sensors.





| Sensor | LOWER range | UPPER range |
|--------------------------------|--------------------|--------------------|
| U2000A, U2001A, U2002A, U2004A | -60 dBm to -10 dBm | -10 dBm to +20 dBm |
| U2000H, U2001H, U2002H | -50 dBm to 0 dBm | 0 dBm to +30 dBm |
| U2000B, U2001B | -30 dBm to +20 dBm | +20 dBm to +44 dBm |

The default is **AUTO**. In **AUTO** the range crossover value depends on the sensor model being used.

| Sensor | Range Crossover Values |
|--------------------------------|------------------------|
| U2000A, U2001A, U2002A, U2004A | -10 dBm \pm 1 dB |
| U2000H, U2001H, U2002H | 0 dBm \pm 1 dB |
| U2000B, U2001B | +20 dBm \pm 1 dB |

Procedure

Set the range as follows:

- 1 Press . On dual channel meters, select the required channel.
- 2 The **Range:** setting field will be selected. Press  to display the **Range** pop-up.
- 3 Use the  and  keys to select the required setting.
- 4 Press  to complete the entry.

Measurement Considerations

While autoranging is a good starting point, it is not ideal for all measurements. Signal conditions such as crest factor or duty cycle may cause the power meter to select a range which is not the optimum configuration for your specific measurement needs. Signals with average power levels close to the range switch point require you to consider your needs for measurement accuracy and speed. For example, using an U2000/1/4A sensor, where the range switch point is -10 ± 1 dBm in a pulsed signal configured as follows:

| Characteristic | Value |
|----------------|--------|
| Peak Amplitude | -6 dBm |
| Duty Cycle | 25% |

The calculated average power is -12 dBm.

Accuracy

The value of -12 dBm lies in the lower range of the U2000/1/4A sensor. In autoranging mode (**"AUTO"**), the power meter determines the average power level is below -10 dBm and selects the low power path. However, the peak amplitude of -6 dBm is beyond the specified, square law response range of the low power path diodes. The high power path (-10 dBm to $+20$ dBm) should be used to ensure a more accurate measurement of this signal. However, range holding in **"UPPER"** (the high power path), for a more accurate measurement, results in a considerably increased number of filtering processes.

Speed and Averaging

The same signal also requires that consideration is given to measurement speed. As shown above, in autoranging mode the power meter selects the low power path in the U2000/1/4A sensor. With auto-averaging also configured, minimal filtering is applied. Values of one to four for average power levels above -20 dBm are used in the low power path. (Refer to **"U2000 Series auto-averaging settings"** on page 198.)

If the range is held in **"UPPER"** for more accuracy, the measurement is slower. More filtering is applied due to the increase in noise susceptibility at the less sensitive area of the high power path. Values of one to 128 for average power levels less than -10 dBm are used. (Again, refer to **"U2000 Series auto-averaging settings"** on page 198.) Manually lowering the filter settings speeds up the measurement but can result in an unwanted level of jitter.

Summary

Attention must be paid to signals whose average power levels are in the low power path range whilst their peaks are in the high power path range. You can achieve best accuracy by selecting the high power path or best speed by selecting the low power path.

THIS PAGE HAS BEEN INTENTIONALLY LEFT BLANK.

8 Using U8480 Series USB Thermocouple Sensors

| | |
|---------------------------|-----|
| Introduction | 208 |
| Power Meter Configuration | 209 |
| Measurement Accuracy | 211 |
| Zeroing | 213 |
| Calibrating | 215 |
| Zero+Cal | 217 |
| FDO Table Editing | 217 |
| Reference Manual | 218 |

This chapter describes how to use your U8480 Series USB thermocouple sensors with N1913/1914A EPM Series power meters

Introduction

The U8480 Series is a USB-based standalone thermocouple power sensor and meter. The U8480 Series consists of two models; U8481A (DC to 18 GHz) and U8485A (DC to 33 GHz). The U8480 Series allows direct measurement of average RF or microwave power through the heating effect it has on a terminating load. It measures power from -35 dBm to 20 dBm, at a DC to 33 GHz frequency range.

Please refer to the documentation supplied with your U8480 Series USB thermocouple sensors for specifications and calibration information.

Power Meter Configuration

The N1913/1914A EPM Series power meters automatically recognize an U8480 Series USB thermocouple sensor when it is connected. The sensor calibration data is automatically read by the power meter. The power meter also configures the auto-averaging settings shown in [Figure 8-1](#) to suit the thermocouple sensor characteristics.

NOTE

These values are valid only for the power meter channel connected with U8480 Series USB thermocouple sensors.

| Dynamic range | Maximum power | Resolution setting | | | |
|---------------|---------------|--------------------|----|-----|-----|
| | | 1 | 2 | 3 | 4 |
| 20 dBm | | 1 | 1 | 2 | 8 |
| 10 dBm | | 1 | 1 | 2 | 8 |
| 0 dBm | | 2 | 2 | 4 | 32 |
| -10 dBm | | 2 | 2 | 16 | 256 |
| -20 dBm | | 2 | 8 | 128 | 256 |
| -30 dBm | | 4 | 64 | 256 | 512 |
| -35 dBm | Minimum power | | | | |
| | | Number of averages | | | |

Figure 8-1 U8480 Series auto-averaging settings

Default Channel Setup

When an U8480 Series USB thermocouple sensor is connected, the following **Channel Setup** is automatically configured. Carrying out a Preset returns the power meter to this configuration. The U8480 Series thermocouple sensor does not support auto-ranging.

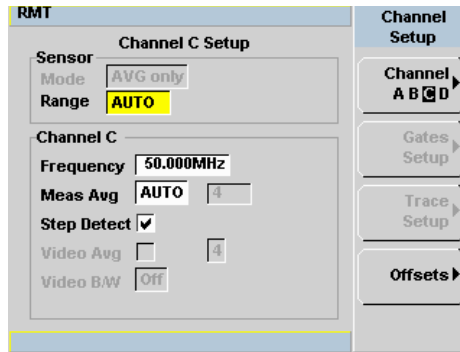

Figure 8-2 U8480 Series USB power sensor default channel setup

Measurement Accuracy





Thermocouple sensors have small errors in their response over frequency. The response of each sensor is measured during manufacture to determine correction factors. With the U8480 Series thermocouple sensors, correction factors are stored in a 3 MB Flash memory and are downloaded to the power meter automatically.

Using calibration factors enables improved measurement accuracy. This section describes making average power measurements using the U8480 Series thermocouple sensors.

Making a measurement requires the following steps:

- 1 Zero the power meter/power sensor combination.
- 2 Set the frequency for the signal you want to measure.
- 3 Make the measurement.

Procedure

- 1 Zero the power meter/thermocouple sensor combination.
- 2 Ensure the power sensor is disconnected from any signal source.
- 3 Press  and the channel **Zero** softkey. Select the required channel. Now, set the frequency of the signal you want to measure. The thermocouple meter automatically selects the appropriate calibration factor.
- 4 Press . On dual channel meters select the required channel.
- 5 Use the  and  keys to highlight the **Frequency** value field and press  to display the **Frequency** pop-up. Use the numeric keypad to enter the required value in the **Frequency** pop-up window.

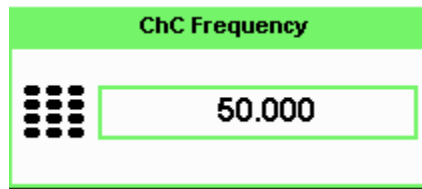



Figure 8-3 Frequency pop-up

6 Confirm your choice by pressing **MHz** or **GHz**.

7 Press  key to close the **Channel Setup** screen.

8 Proceed to make the measurement.

9 Reconnect any required attenuators or adaptors and connect the thermocouple sensor to the signal to be measured.

The corrected measurement result is displayed.

Zeroing

The N1913/1914A EPM Series power meters support the ability to perform zeroing on the U8480 USB thermocouple sensor via the front panel and SCPI. However, the N1913/1914A EPM Series power meters do not support the choosing of the zeroing type and auto zeroing for the U8480 USB thermocouple sensor. When zeroing is triggered via the front panel or SCPI, the following pop-up message shall appear:

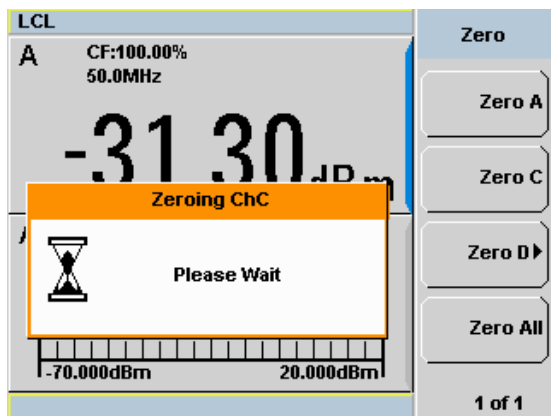

Figure 8-4 Zeroing pop-up message

Should an error occur during zeroing, the following pop-up message will appear:

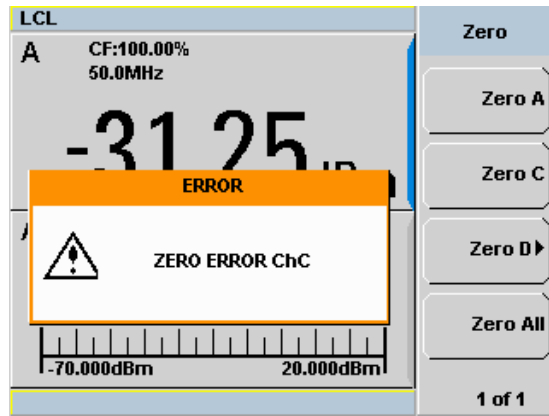

Figure 8-5 Zeroing error pop-up message

Error messages will be logged in the Error Log in **System > Error List**.

Calibrating

The N1913/1914A EPM Series power meters are able to perform calibration for the U8480 USB thermocouple sensor via the front panel and SCPI. The N1913/1914A EPM Series power meters also support auto calibration (**Auto Cal**) for the U8480 USB thermocouple sensor. Both internal (**Int**) and external (**Ext**) calibration is supported by the N1913/1914A EPM Series power meters.

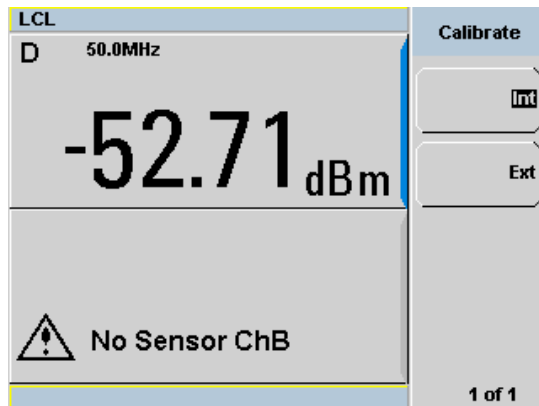

Figure 8-6 Calibration type

The Auto Cal state is determined by the state of the calibration type as shown in [Figure 8-6](#). If the calibration type is set to **Int**, you will be able to toggle between **On** and **Off** under the **Auto Cal** state. If the calibration type is set to **Ext**, the **Auto Cal** state will be set to **Off** and the softkey will be greyed out.

When calibration is performed via the front panel or SCPI, the following message will appear:

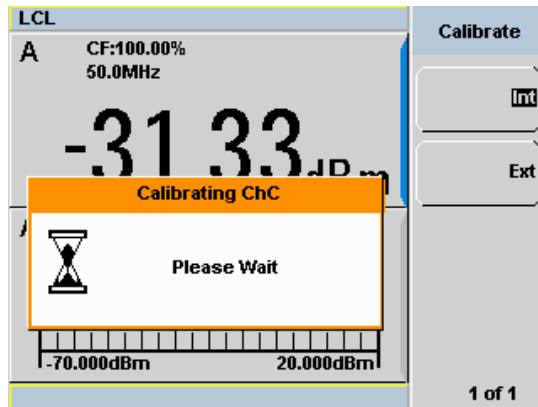

Figure 8-7 Calibration pop-up message

Should an error occur during calibration, the following pop-up message will appear:

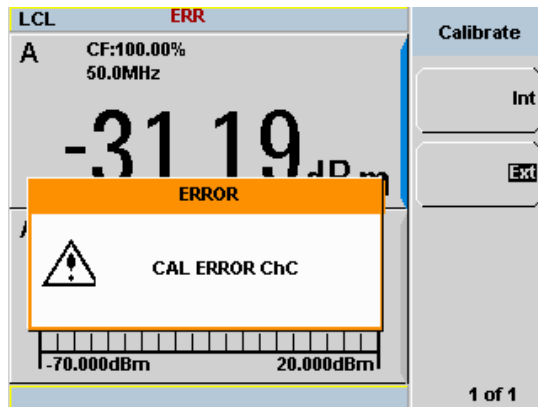

Figure 8-8 Calibration error pop-up message

Error messages will be logged in the Error Log in **System > Error List**.

Zero+Cal

The N1913/1914A EPM Series power meters are able to perform **Zero+Cal** for the U8480 USB thermocouple sensor via the front panel and SCPI. The **Zero+Cal** softkey will be greyed out if no sensor is connected to that particular channel. When the **Zero+Cal** softkey is pressed, zeroing and external calibration will be triggered for the U8480 USB thermocouple sensor. The calibration type will not be changed. The U8480 USB thermocouple sensor should be connected to the reference calibrator before **Zero+Cal** is performed.

FDO Table Editing

When editing FDO table entries, the kHz softkey will be enabled when a U8480 USB thermocouple sensor is connected to a N1913/1914A EPM Series power meter. The minimum entry for the frequency value is 0 kHz.

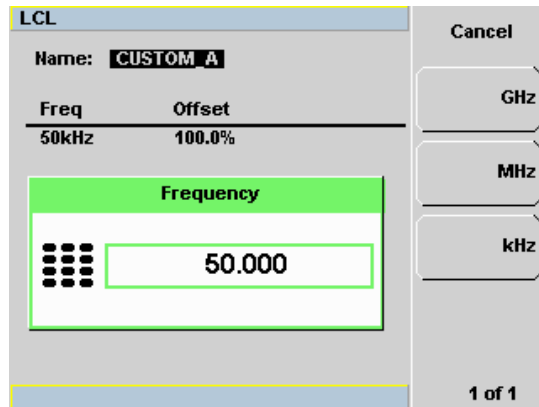

Figure 8-9 FDO table editing

Reference Manual

A link to the reference manuals is available under **System > Service** in the form of a QR code. The softkey is as shown in the figure below:

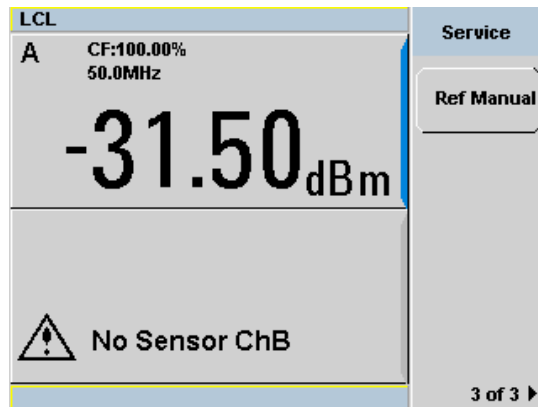

Figure 8-10 Reference manual softkey

When you press the softkey, a screen containing a QR code appears:



Figure 8-11 QR code screen

To exit this screen, you may use either one of the following steps:

- 1 Press any front panel key.
- 2 Place the N1913/1914A EPM Series power meters in remote (RMT) mode.

9 Maintenance

| | |
|--|-----|
| Self Test | 220 |
| Error Messages | 224 |
| Operator Maintenance | 233 |
| Connector Maintenance | 234 |
| Contacting Keysight Technologies | 235 |
| Erasing Memory Data | 238 |
| Returning Your Power Meter for Service | 239 |

This chapter describes the built-in tests, error messages and general maintenance.

Self Test

The power meter's troubleshooting mode self test can be accessed via the front panel or remotely. The front panel softkey menu allows you to run individual tests, whereas the remote command runs a complete series of tests as listed in “[Remote Testing](#)” on page 222.

Front Panel Selection of Self Tests

Press  **System**, **1 of 2**, **Service**, **Self Test** to access the **Self Test** menu that consists of the following:

- Instrument Self Test
- Keyboard
- Bitmaps Displays
- RTC Battery
- Time Base

Instrument Self Test

If **Self Test** is selected, the following tests are run: (These are the same tests which are run using the ***TST?** command.)

- Test Point Voltages
- Calibrator
- Fan
- RTC Battery
- Channel CW Path

As each test takes place, the name of the test is listed on the screen. While a test is running, the message **Testing...** appears beside the name of the test. As each stage of the test is completed, the **Testing...** message is replaced by either **Passed** or **Failed**.

| RMT | | Self Test |
|---------------------|--------|-----------|
| TEST | RESULT | |
| Test Point Voltages | Passed | |
| Calibrator | Passed | |
| Fan | Passed | |
| RTC Battery | Passed | |
| ChA CW Path | Passed | |
| ChB CW Path | Passed | |
| | | Done |

Figure 9-1 Self test complete

When the test is complete, the result will be displayed. Press **Done** to return to the **Service** menu.

If the self test failed, information about the failure is displayed on the screen.

Remote Testing

To invoke the remote self test, the IEEE 488.1 compliant standard command, ***TST?** is used. This command runs a full self test and returns one of the following codes:

- 0 -no tests failed
- 1 -one or more tests failed

The remote self test consists of the following tests:

The communications assembly is tested implicitly, in that the command will not be accepted or return a result unless the remote interface is functioning correctly.

Refer to “[Test Descriptions](#)” on page 222 if you require a description of each individual test.

When the ***TST?** command is executed, the screen is cleared. As each test takes place, the name of the test is listed on the screen. While a test is running, the message **Testing...** appears beside the name of the test. As each stage of the test is completed, the message **Testing...** is replaced by either the message **Passed** or **Failed**.

Test Descriptions

This section specifies what is actually checked by each of the tests. Some of the tests may only be applicable to one method of invocation (for example, from the front panel). If this is the case, it is specified in the test description. Most of the tests have an associated error message which is added to the error queue if the test fails. The exception to this is the bitmap display test. Refer to “[Error Messages](#)” on page 224 for more details.

Test Point Voltages

An array of test on various DC voltages inside power meter.

Calibrator

The reference calibrator is turned on (indicated by the POWER REF LED) and measured internally. A pass or fail result is returned.

Fan

This test confirms that the internal cooling fan is operating.

Real Time Clock (RTC) Battery

The RTC battery provides power for the real time clock circuitry on the motherboard when the power meter is powered off. The real time clock is used to provide the timestamp needed for N8480 Series power sensors' aging sense data.

During RTC battery test, the RTC battery power level is determined by converting the ADC value of the RTC battery power level read from the FPGA, to voltage level. If the battery power level is less than a pre-specified threshold (threshold to be defined later), the test will fail. An error will be logged in the error list if the test fails.

Channel CW Path

A brief test on CW meter linearity performance.

NOTE

Ensure that all power sensors have been disconnected from the meter before performing self-test.

Error Messages

Introduction

This section contains information about error messages. It explains how to read the power meter's error queue and lists all error messages and their probable causes.

When there is a hardware related problem, for example, a power sensor overload, the error message is displayed on the status line at the top of the display. In addition, the errors are also written to the error queue. If there are any errors in the error queue the front panel error indicator is displayed as shown in [Figure 9-2](#).

Other errors can also be generated when the power meter is being operated over the remote interface. These errors also display the error indicator and are written to the error queue.

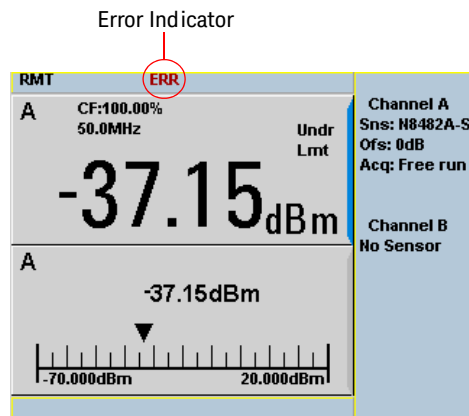

Figure 9-2 Error indicator position

To read the error queue from the front panel:

- Press , **Error List** and use **Next** to scroll through each error message.

To read the error queue from the remote interface use:

- the **SYSTem:ERRor?** command.

Error queue messages have the following format:

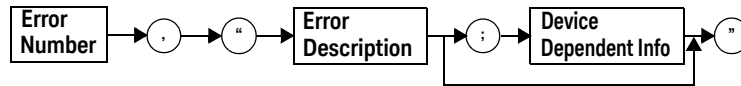

Error Queue Message

For example, -330, "Self-test Failed;Battery Fault".

Errors are retrieved in a first in first out (FIFO) order. If more than 30 errors occur, the error queue overflows and the last error in the queue is replaced with error -350, "Queue Overflow". Any time the queue overflows the most recent error is discarded.

When the errors are read they are removed from the error queue. This opens a position at the end of the queue for a new error message, if one is subsequently detected. When all errors have been read from the queue, further error queries return +0, "No errors".

To delete all the errors in the queue from the front panel press:

- Press , **Error List** and use **Clear Errors**.

To delete all the errors in the queue remotely use:

- the ***CLS** (clear status) command.

The error queue is also cleared when the instrument power has been switched off.

Error Message List

| | |
|------|--|
| -101 | <p>Invalid character</p> <p>An invalid character was found in the command string. You may have inserted a character such as #, \$, or % in the command header or within a parameter.</p> <p>For example, LIM:LOW O#.</p> |
| -102 | <p>Syntax error</p> <p>Invalid syntax was found in the command string.</p> <p>For example, LIM:CLE:AUTO, 1 or LIM:CLE: AUTO 1.</p> |
| -103 | <p>Invalid separator</p> <p>An invalid separator was found in the command string. You may have used a comma instead of a colon, semicolon, or blank space; or you may have used a blank space instead of a comma.</p> <p>For example, OUP:ROSC,1.</p> |
| -105 | <p>GET not allowed</p> <p>A Group Execute Trigger (GET) is not allowed within a command string.</p> |
| -108 | <p>Parameter not allowed</p> <p>More parameters were received than expected for the command. You may have entered an extra parameter, or added a parameter to a command that does not accept a parameter.</p> <p>For example, CAL 10.</p> |
| -109 | <p>Missing parameter</p> <p>Fewer parameters were received than expected for the command. You omitted one or more parameters that are required for this command. For example, AVER:COUN.</p> |
| -112 | <p>Program mnemonic too long</p> <p>A command header was received which contained more than the maximum 12 characters allowed.</p> <p>For example, SENS:AVERAgeCOUNT 8.</p> |
| -113 | <p>Undefined header</p> <p>A command was received that is not valid for this power meter. You may have misspelled the command, it may not be a valid command or you may have the wrong interface selected. If you are using the short form of the command, remember that it may contain up to four letters.</p> <p>For example, TRIG:SOUR IMM.</p> |
| -121 | <p>Invalid character in number</p> <p>An invalid character was found in the number specified for a parameter value.</p> <p>For example, SENS:AVER:COUN 128#H.</p> |
| -123 | <p>Exponent too large</p> <p>A numeric parameter was found whose exponent was larger than 32,000.</p> <p>For example, SENS:COUN 1E34000.</p> |

| | |
|------|---|
| -124 | <p>Too many digits</p> <p>A numeric parameter was found whose mantissa contained more than 255 digits, excluding leading zeros.</p> |
| -128 | <p>Numeric data not allowed</p> <p>A numeric value was received within a command which does not accept a numeric value. For example, MEM:CLE 24.</p> |
| -131 | <p>Invalid suffix</p> <p>A suffix was incorrectly specified for a numeric parameter. You may have misspelled the suffix. For example, SENS:FREQ 200KZ.</p> |
| -134 | <p>Suffix too long</p> <p>A suffix used contained more than 12 characters. For example, SENS:FREQ 2MHZZZZZZZZZZ.</p> |
| -138 | <p>Suffix not allowed</p> <p>A suffix was received following a numeric parameter which does not accept a suffix. For example, INIT:CONT OHZ.</p> |
| -148 | <p>Character data not allowed</p> <p>A discrete parameter was received but a character string or a numeric parameter was expected. Check the list of parameters to verify that you have used a valid parameter type. For example, MEM:CLE CUSTOM_1.</p> |
| -151 | <p>Invalid string data</p> <p>An invalid string was received. Check to see if you have enclosed the character string in single or double quotes. For example, MEM:CLE "CUSTOM_1.</p> |
| -158 | <p>String data not allowed</p> <p>A character string was received but is not allowed for the command. Check the list of parameters to verify that you have used a valid parameter type. For example, LIM:STAT 'ON'.</p> |
| -161 | <p>Invalid block data</p> <p>A block data element was expected but was invalid for some reason. For example, *DDT #15FET. The 5 in the string indicates that 5 characters should follow, whereas in this example there are only 3.</p> |
| -168 | <p>Block data not allowed</p> <p>A legal block data element was encountered but not allowed by the power meter at this point. For example, SYST:LANG #15FETC?.</p> |
| -178 | <p>Expression data not allowed</p> <p>A legal expression data was encountered but not allowed by the power meter at this point. For example, SYST:LANG (5+2).</p> |

| | |
|------|---|
| -211 | <p>Trigger ignored</p> <p>Indicates that <GET> or *TRG, or TRIG:IMM was received and recognized by the device but was ignored because the power meter was not in the wait for trigger state.</p> |
| -213 | <p>Init ignored</p> <p>Indicates that a request for a measurement initiation was ignored as the power meter was already initiated. For example, INIT:CONT ON INIT.</p> |
| -214 | <p>Trigger deadlock</p> <p>TRIG:SOUR was set to HOLD or BUS and a READ? or MEASure? was attempted, expecting TRIG:SOUR to be set to IMMEDIATE.</p> |
| -220 | <p>Parameter error;Frequency list must be in ascending order.</p> <p>Indicates that the frequencies entered using the MEMory:TABLE:FREQuency command are not in ascending order.</p> |
| -221 | <p>Settings conflict</p> <p>This message occurs under a variety of conflicting conditions. The following list gives a few examples of where this error may occur:</p> <p>If the READ? parameters do not match the current settings.</p> <p>If you are in fast mode and attempting to switch on for example, averaging, duty cycle or limits.</p> <p>Trying to clear a sensor calibration table when none is selected.</p> |
| -222 | <p>Data out of range</p> <p>A numeric parameter value is outside the valid range for the command.</p> <p>For example, SENS:FREQ 2 kHz.</p> |
| -224 | <p>Illegal parameter value</p> <p>A discrete parameter was received which was not a valid choice for the command. You may have used an invalid parameter choice.</p> <p>For example, TRIG:SOUR EXT.</p> |
| -226 | <p>Lists not same length</p> <p>This occurs when SENS:CORRection:CSET[1]CSET2:STATe is set to ON and the frequency and calibration/offset lists do not correspond in length.</p> |
| -230 | <p>Data corrupt or stale</p> <p>This occurs when a FETC? is attempted and either a reset has been received or the power meter state has changed such that the current measurement is invalidated (for example, a change of frequency setting or triggering conditions).</p> |
| -230 | <p>Data corrupt or stale;Please zero and calibrate Channel A</p> <p>When CAL[1]2:RCAL is set to ON and the sensor currently connected to Channel A has not been zeroed and calibrated, then any command which would normally return a measurement result (for example FETC?, READ?, or MEAS?) will generate this error message.</p> |

| | |
|------|---|
| -230 | Data corrupt or stale;Please zero and calibrate Channel B When CAL[1 2]:RCAL is set to ON and the sensor currently connected to Channel B has not been zeroed and calibrated, then any command which would normally return a measurement result (for example FETC?, READ?, or MEAS?) will generate this error message. |
| -230 | Data corrupt or stale;Please zero Channel A When CAL[1 2]:RCAL is set to ON and the sensor currently connected to Channel A has not been zeroed, then any command which would normally return a measurement result (for example FETC?, READ?, or MEAS?) will generate this error message. |
| -230 | Data corrupt or stale;Please zero Channel B When CAL[1 2]:RCAL is set to ON and the sensor currently connected to Channel B has not been zeroed, then any command which would normally return a measurement result (for example FETC?, READ?, or MEAS?) will generate this error message. |
| -230 | Data corrupt or stale;Please calibrate Channel A When CAL[1 2]:RCAL is set to ON and the sensor currently connected to Channel B has not been calibrated, then any command which would normally return a measurement result (for example FETC?, READ?, or MEAS?) will generate this error message. |
| -230 | Data corrupt or stale;Please calibrate Channel B When CAL[1 2]:RCAL is set to ON and the sensor currently connected to Channel B has not been calibrated, then any command which would normally return a measurement result (for example FETC?, READ?, or MEAS?) will generate this error message. |
| -231 | Data questionable;CAL ERROR Power meter calibration failed. The most likely cause is attempting to calibrate without applying a 1 mW power to the power sensor. |
| -231 | Data questionable;CAL ERROR ChA Power meter calibration failed on Channel A. The most likely cause is attempting to calibrate without applying a 1 mW power to the power sensor. |
| -231 | Data questionable;CAL ERROR ChB Power meter calibration failed on Channel B. The most likely cause is attempting to calibrate without applying a 1 mW power to the power sensor. |
| -231 | Data questionable;Input Overload The power input to Channel A exceeds the power sensor's maximum range. |
| -231 | Data questionable;Input Overload ChA The power input to Channel A exceeds the power sensor's maximum range. |
| -231 | Data questionable;Input Overload ChB The power input to Channel B exceeds the power sensor's maximum range. |

| | |
|------|--|
| -231 | Data questionable;Lower window log error This indicates that a difference measurement in the lower window has given a negative result when the units of measurement were logarithmic. |
| -231 | Data questionable;Upper window log error This indicates that a difference measurement in the upper window has given a negative result when the units of measurement were logarithmic. |
| -231 | Data questionable;ZERO ERROR Power meter zeroing failed. The most likely cause is attempting to zero when some power signal is being applied to the power sensor. |
| -231 | Data questionable;ZERO ERROR ChA Power meter zeroing failed on Channel A. The most likely cause is attempting to zero when some power signal is being applied to the power sensor. |
| -231 | Data questionable;ZERO ERROR ChB Power meter zeroing failed on Channel B. The most likely cause is attempting to zero when some power signal is being applied to the power sensor. |
| -241 | Hardware missing The power meter is unable to execute the command because either no power sensor is connected or it expects an E-series power sensor and one is not connected. |
| -310 | System error;Dty Cyc may impair accuracy with ECP sensor This indicates that the sensor connected is for use with CW signals only. |
| -310 | System error;Ch A Dty Cyc may impair accuracy with ECP sensor This indicates that the sensor connected to Channel A is for use with CW signals only. |
| -310 | System error;Ch B Dty Cyc may impair accuracy with ECP sensor This indicates that the sensor connected to Channel B is for use with CW signals only. |
| -310 | System error;Sensor EEPROM Read Failed - critical data not found or unreadable This indicates a failure with your E-Series Power Sensor. Refer to your power sensor manual for details on returning it for repair. |
| -310 | System error;Sensor EEPROM Read Completed OK but optional data block(s) not found or unreadable This indicates a failure with your E-Series Power Sensor. Refer to your power sensor manual for details on returning it for repair. |
| -310 | System error;Sensor EEPROM Read Failed - unknown EEPROM table format This indicates a failure with your E-Series Power Sensor. Refer to your power sensor manual for details on returning it for repair. |

| | |
|------|--|
| -310 | System error;Sensor EEPROM < > data not found or unreadable Where < > refers to the sensor data block covered, for example, Linearity, Temp - Comp (temperature compensation). This indicates a failure with your E-Series Power Sensor. Refer to your power sensor manual for details on returning it for repair. |
| -310 | System error;Sensors connected to both front and rear inputs. You cannot connect two power sensors to the one channel input. In this instance the power meter detects power sensors connected to both it's front and rear channel inputs. |
| -351 | Configuration memory lost; storage fault Refer to " Memory Erase/Secure Erase " on page 119 to perform secure erase. |
| -321 | Out of memory The power meter required more memory than was available to run an internal operation. |
| -330 | Self-test Failed; The -330, "Self-test Failed" errors indicate that you have a problem with your power meter. Refer to " Contacting Keysight Technologies " on page 235 for details of what to do with your faulty power meter. |
| -330 | Self-test Failed;Measurement Channel Fault |
| -330 | Self-test Failed;Measurement Channel A Fault |
| -330 | Self-test Failed;Measurement Channel B Fault |
| -330 | Self-test Failed;Calibrator Fault Refer to " Calibrator " on page 222 if you require a description of the calibrator test. |
| -330 | Self-test Failed;ROM Check Failed |
| -330 | Self-test Failed;RAM Check Failed |
| -350 | Queue overflow The error queue is full and another error has occurred which could not be recorded. |
| -361 | Parity error in program The serial port receiver has detected a parity error and consequently, data integrity cannot be guaranteed. |
| -362 | Framing error in program The serial port receiver has detected a framing error and consequently, data integrity cannot be guaranteed. |
| -363 | Input buffer overrun The serial port receiver has been overrun and consequently, data has been lost. |
| -410 | Query INTERRUPTED A command was received which sends data to the output buffer, but the output buffer contained data from a previous command (the previous data is not overwritten). The output buffer is cleared when power has been off, or after *RST (reset) command has been executed. |

| | |
|------|---|
| -420 | Query UNTERMINATED The power meter was addressed to talk (that is, to send data over the interface) but a command has not been received which sends data to the output buffer. For example you may have executed a CONFIGure command (which does not generate data) and then attempted to read data from the remote interface. |
| -430 | Query DEADLOCKED A command was received which generates too much data to fit in the output buffer and the input buffer is also full. Command execution continues but data is lost. |
| -440 | Query UNTERMINATED after indefinite response The *IDN? command must be the last query command within a command string. |

Operator Maintenance

This section describes how to replace the power line fuse and clean the power meter. If you need additional information about replacing parts or repairing the power meter, refer to the *EPM Series Power Meter Service Guide*.

To clean the power meter, disconnect its supply power and wipe with a damp cloth only.

The power line fuse is located within the power meter's fuse holder assembly on the rear panel. For all voltages, the power meter uses a 250 V, T2.5 H, 20 mm slow blow fuse with high breaking capacity.

NOTE

The power meter also has an internal fuse. If you suspect that this fuse needs to be replaced, it must be done by trained service personnel. Please refer to **“Returning Your Power Meter for Service”** on page 239.

Replacing the Power Line Fuse

- 1 Slide the fuse holder assembly from the rear panel as shown in [Figure 9-3](#).
- 2 Install the correct fuses in the respective “In line” positions as shown in [Figure 9-3](#). (The N1913A/1914A requires two fuses.)
- 3 Replace the fuse holder assembly in the rear panel.

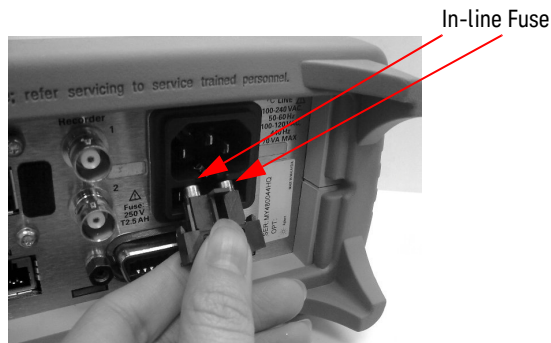

Figure 9-3 Replacing the fuses

Connector Maintenance

Stable and repeatable measurements can only be achieved if the devices are clean and undamaged. Careful and consistent connections are also necessary to achieve maximum stability and repeatability. Therefore, always handle the devices with care, do not overtighten them, and keep them properly stored when not in use.

Precision connectors should be regularly cleaned and gauged – measured with a special dial gauge to ensure that they have not been mechanically damaged. A damaged connector can instantly ruin the mated part.

Ensure the steps below are followed:

- Select the test equipment for the lowest SWR.
- Keep the cable length as short as possible.
- Use good quality cables.
- Select the appropriate connectors.
- Keep the connectors clean.
- Measure (gauge) the connectors regularly.
- Replace faulty, worn, or damaged cables and connectors promptly.
- Do not make your own cables for use at high frequencies unless you test them first.
- Minimize the number of adapters.
- If possible, use semi-rigid cables for permanently connected cables.
- Follow the cable manufacturer's recommendation for minimum bend-radius.
- Fix the measurement equipment to the bench if possible (or rack it up).
- Do not overtighten connectors and do not allow them to become loose – use a torque wrench.
- Do not mate dissimilar families, for example APC-3.5 and SMA.
- Avoid temperature extremes.

Contacting Keysight Technologies

This section details what to do if you have a problem with your power meter.

If you have a problem with your power meter, first refer to the section [Before calling Keysight Technologies](#). This chapter contains a checklist that will help identify some of the most common problems.

If you wish to contact Keysight Technologies about any aspect of the power meter, from service problems to ordering information, refer to [“”](#) on page 240.

If you wish to return the power meter to Keysight Technologies refer to [“Returning Your Power Meter for Service”](#) on page 239.

Before calling Keysight Technologies

Before calling Keysight Technologies or returning the power meter for service, please make the checks listed in [“Check the Basics”](#) on page 236. If you still have a problem, please read the warranty printed at the front of this guide. If your power meter is covered by a separate maintenance agreement, please be familiar with the terms.

Keysight Technologies offers several maintenance plans to service your power meter after warranty expiration. Call your Keysight Technologies Sales and Service Center for full details.

If the power meter becomes faulty and you wish to return the faulty instrument, follow the description on how to return the faulty instrument in the section [“Contacting Keysight Technologies”](#) on page 235.

Check the Basics

Problems can be solved by repeating what was being performed when the problem occurred. A few minutes spent in performing these simple checks may eliminate time spent waiting for instrument repair. Before calling Keysight Technologies or returning the power meter for service, please make the following checks:

- Check that the line socket has power.
- Check that the power meter is plugged into the proper ac power source.
- Check that the power meter is switched on.
- Check that the line fuse is in working condition.
- Check that the other equipment, cables, and connectors are connected properly and operating correctly.
- Check the equipment settings in the procedure that was being used when the problem occurred.
- Check that the test being performed and the expected results are within the specifications and capabilities of the power meter.
- Check the power meter display for error messages.
- Check operation by performing the self tests.
- Check with a different power sensor.

Instrument serial numbers

Keysight Technologies makes frequent improvements to its products to enhance their performance, usability and reliability. Keysight Technologies service personnel have access to complete records of design changes for each instrument. The information is based on the serial number and option designation of each power meter.

Whenever you contact Keysight Technologies about your power meter have a complete serial number available. This ensures you obtain the most complete and accurate service information. The serial number can be obtained by:

- interrogating the power meter over the remote interface using the *IDN? command.

- from the front panel by pressing , **1 of 2**, **Service**, **Version**.
- from the serial number label.

The serial number label is attached to the rear of each Keysight Technologies instrument. This label has two instrument identification entries. The first provides the instruments serial number and the second provides the identification number for each option built into the instrument.

The serial number is divided into two parts: the prefix (two letters and the first four numbers), and the suffix (the last four numbers).

- The prefix letters indicate the country of manufacture. This code is based on the ISO international country code standard, and is used to designate the specific country of manufacture for the individual product. The same product number could be manufactured in two different countries. In this case the individual product serial numbers would reflect different country of manufacture codes. The prefix also consists of four numbers. This is a code identifying the date of the last major design change.
- The suffix indicates an alpha numeric code which is used to ensure unique identification of each product throughout Keysight Technologies.

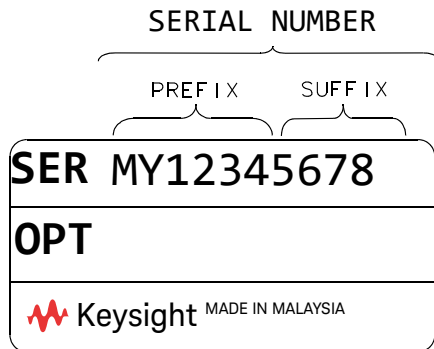

Recommended Calibration Interval

Keysight Technologies recommends a two- years calibration cycle for the N1913/1914A EPM Series power meter.

Erasing Memory Data

If you need to erase the EPM Series Power Meter's memory, for example, before you return it to Keysight Technologies for repair or calibration, of all data stored in it.

The memory data erased includes the save/recall states and power on last states.

The following procedure explains how to do this.

- 1 Press the  key.
- 2 Press **1 of 2**.
- 3 Press **Service**.
- 4 Press **Secure Erase**.
- 5 If you are sure, press the **Confirm** key.
- 6 A pop-up appears, as shown in [Figure 9-4](#) informing you of the status of the procedure.



Figure 9-4 Secure erase status pop-up

Returning Your Power Meter for Service

Use the information in this section if you need to return your power meter to Keysight Technologies.

Packaging the Power Meter for Shipment

Use the following steps to package the power meter for shipment to Keysight Technologies for service:

- Fill in a blue service tag (available at the end of this guide) and attach it to the power meter. Please be as specific as possible about the nature of the problem. Send a copy of any or all of the following information:
 - Any error messages that appeared on the power meter display.
 - Any information on the performance of the power meter.

CAUTION

Power meter damage can result from using packaging materials other than those specified. Never use styrene pellets in any shape as packaging materials. They do not adequately cushion the power meter or prevent it from shifting in the carton. Styrene pellets cause power meter damage by generating static electricity and by lodging in the rear panel.

-
- Use the original packaging materials or a strong shipping container that is made of double-walled, corrugated cardboard with 91 kg (200 lb.) bursting strength. The carton must be both large enough and strong enough to accommodate the power meter and allow at least 3 to 4 inches on all sides of the power meter for packing material.
 - Surround the power meter with at least 3 to 4 inches of packing material, or enough to prevent the power meter from moving in the carton. If packing foam is not available, the best alternative is SD-240 Air Cap™ from Sealed Air Corporation (Commerce, CA 90001). Air Cap looks like a plastic sheet covered with 1-1/4 inch air filled bubbles. Use the pink Air Cap to reduce static electricity. Wrap the power meter several times in the material to both protect the power meter and prevent it from moving in the carton.
 - Seal the shipping container securely with strong nylon adhesive tape.
 - Mark the shipping container “FRAGILE, HANDLE WITH CARE” to ensure careful handling.
 - Retain copies of all shipping papers.

THIS PAGE HAS BEEN INTENTIONALLY LEFT BLANK.

10 Characteristics and Specifications

For the characteristics and specifications of the N1913/1914A EPM Series Power Meters, refer to the datasheet at <http://literature.cdn.keysight.com/litweb/pdf/5990-4019EN.pdf>.

THIS PAGE HAS BEEN INTENTIONALLY LEFT BLANK.



This information is subject to change without notice. Always refer to the Keysight website for the latest revision.

© Keysight Technologies 2009–2018
Edition 20, February 12, 2018

Printed in Malaysia



N1913-90001

www.keysight.com