

RIGOL

DSA700 Rack Mount Kit

This rack mount kit is designed to mount **RIGOL** DSA700 series spectrum analyzer into a standard 19-inch cabinet that conforms to the Electronic Industries Association (EIA) standard.

Kit Part Checklist

No.	Name	Qty.	Description
1	Front Plate	1	--
2	Left Plate	1	--
3	M4 Screw	14	M4 × 8 Phillips Pan Head Screw
4	Spring Washer	4	--
5	Washer	4	--
6	Bottom Plate	1	--
7	Retaining Bracket	2	--
8	Right Plate	1	--
9	M6 Screw	4	M6 × 16 Phillips Pan Head Screw
10	M6 Nut	4	M6 Square Lock Cage Nut

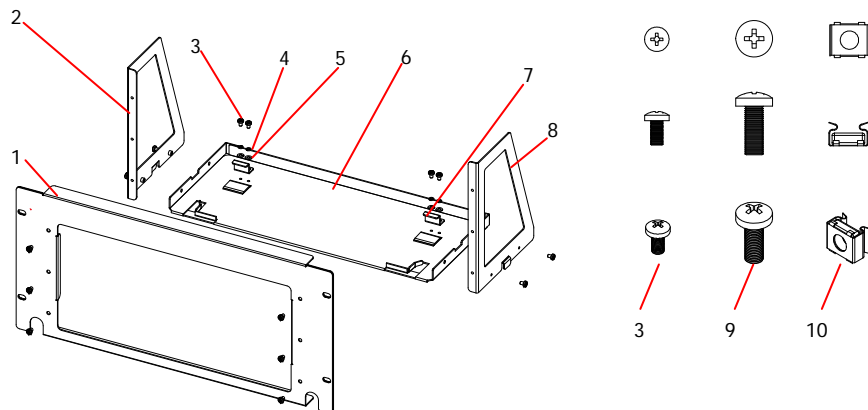

Installation Tool

The PH2 Phillips screwdriver is recommended.

Space Requirements

To mount the instrument into the cabinet correctly, please ensure that the following requirements are met.

- The cabinet must be a standard 19-inch one.
- The available height of the cabinet should be at least 5U (222.25 mm).
- The depth of the cabinet should be at least 200 mm.

The dimensions of the rack-mounted instrument are as shown below.

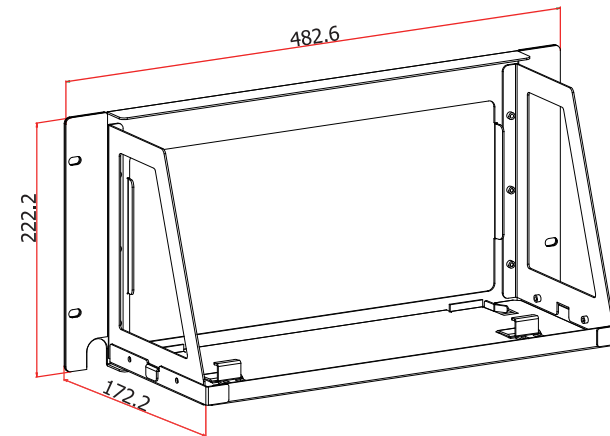

Unit: mm

Installation Procedures



CAUTION

Only authorized operators are allowed to perform the installation. Improper installation might cause damage to the instrument or an installation failure.

1. Mount the left and right plates

Align the detents of the left and right plates with the openings on both sides of the bottom plate respectively and insert them into the bottom plate, then fasten them using four M4 screws.

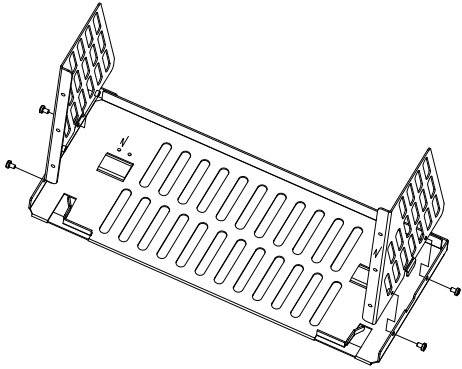

2. Mount the front plate

Attach the front plate to the assembled shelf, and then secure them with six M4 screws.

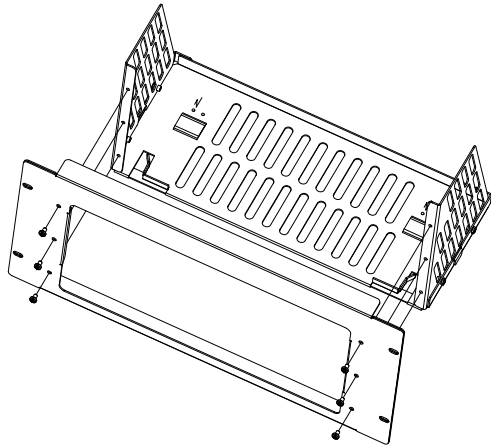

3. Place and fasten the instrument

Place the instrument into the confined position on the bottom plate. Fasten the instrument to the bottom plate using four spring washers, four washers, two retaining brackets and four M4 screws.

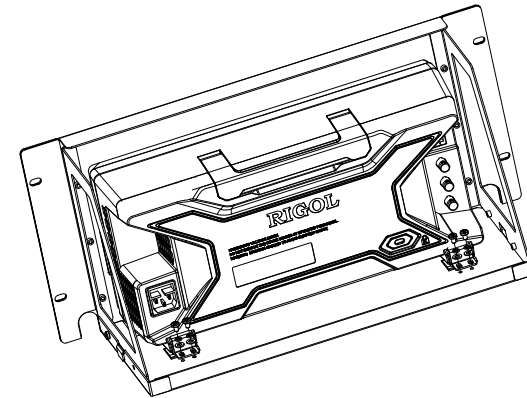

4. Get encased in the cabinet

Mount the assembled instrument and rack into a standard 19-inch cabinet using four M6 screws and four M6 square nuts.

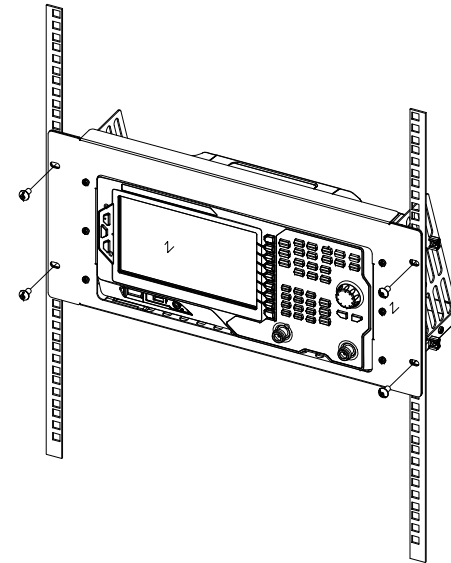

-End-