

Features

- Frequency Range:
150 kHz to 230 MHz
- Current Ratings of 25, 50 and 100 Amps
- Single-Line (M1), Two-Line (M2),
Three-Line (M3), Four-Line (M4)
and Five-Line (M5) Models
- Fully Compliant with
CISPR 16-1-2 and IEC 61000-4-6
- Three-Year Warranty

Description

The M-series Coupling/Decoupling Networks (CDNs) are designed specifically for conducted disturbance immunity tests performed on power lines according to IEC 61000-4-6.

The CDN M-series consists of the following models:

CDN MODEL	LINE(S)	CURRENT RATING
CDN M125E	1	25A per line
CDN M225E	2	
CDN M325E	3	
CDN M425E	4	
CDN M525E	5	
CDN M250E	2	50A per line
CDN M350E	3	
CDN M450E	4	
CDN M1100	1	100A per line
CDN M2100	2	

It should be noted that the total number of power line conductors for the Equipment Under Test (EUT), including line(s), neutral and safety ground, must be equal to the number of lines integral to the CDN.

Each CDN is provided with two (2) Common Mode (or shorting) Adapters. These adapters are used to short circuit each of the CDN power conductors at the EUT and Auxiliary Equipment (AE) port during calibration of test levels, and also during measurement of the CDN electrical performance parameters (impedance, phase, voltage division factor, isolation, etc.).



All Com-Power CDNs can be purchased separately or as part of a CIS-series conducted immunity test system. These test systems include an ACS-series power amplifier, power attenuators, directional coupler, 150Ω to 50Ω adapters, coaxial test cables and optional calibration and test software.



Application

M-series CDNs provide a means by which common mode RF energy can be coupled onto the EUT power lines while maintaining the required impedance over the ground plane, without interruption of input power. Common mode decoupling is also employed to minimize interference to the power source and/or auxiliary equipment. A basic diagram of the CDN circuit is illustrated below.

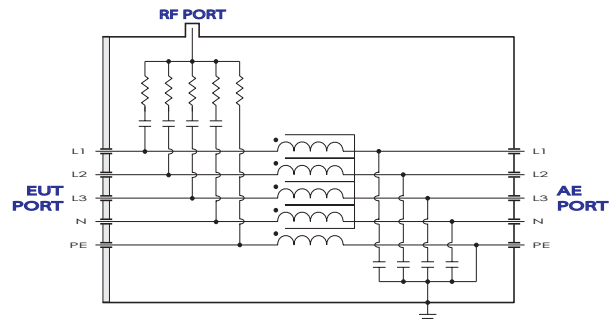

The frequency range of the test is from 150 kHz up to either 80 or 230 MHz. The test level is typically 1, 3 or 10 Vrms with the test signal 80% AM modulated with a 1 kHz tone. A typical test setup is illustrated below.

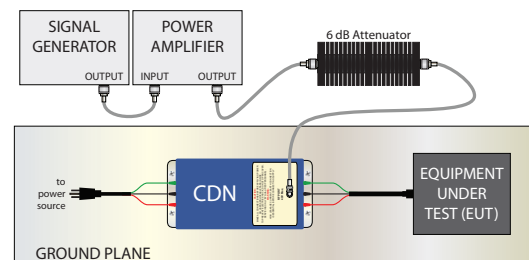

Calibration

Each LISN is individually calibrated in compliance with the relevant requirements of IEC 61000-4-6 and CISPR 16-1-2. Calibration data is supplied with each unit, along with the certificate of calibration, traceable to NIST. Recognized ISO 17025 accredited calibration is also available upon request.

Rev. D06.18

Specifications

		CDN M125E	CDN M225E	CDN M325E	CDN M425E	CDN M525E	CDN M250E	CDN M350E	CDN M450E	CDN M1100	CDN M2100
GENERAL											
Product Description		Power Line Coupling/Decoupling Networks (CDNs)									
Application		Power Line Conducted Immunity Tests									
Standards		IEC 61000-4-6, CISPR 16-1-2									
Number of Power Line Conductors		1	2	3	4	5	2	3	4	1	2
Common Mode Adapters (2 each)		CDN ADA-M125E	CDN ADA-M225E	CDN ADA-M325E	CDN ADA-M425E	CDN ADA-M525E	CDN ADA-M250E	CDN ADA-M350E	CDN ADA-M450E	CDN ADA-M1100E	CDN ADA-M2100E
Frequency Range		150 kHz to 230 MHz									
Common Mode Impedance	150 kHz to 24 MHz	150Ω (±20Ω)									
	24 MHz to 80 MHz	150Ω (-45Ω / +60Ω)									
	80 MHz to 230 MHz	150Ω (±60Ω)									
Decoupling Attenuation (Isolation) *	150 kHz to 1.5 MHz	15-50 dB	25-55 dB	50 dB	50 dB	50 dB	25-55 dB	40 dB	40 dB	20-45 dB	20-45 dB
	1.5 MHz to 230 MHz	50-20 dB	55-15 dB	50-20 dB	50-10 dB	50-5 dB	55-15 dB	40-20 dB	40-10 dB	45-20 dB	45-20 dB
* slopes increase/decrease linearly with the logarithm of frequency											
Voltage Division Factor		9.5 dB									
Voltage Division Factor	150 kHz to 10 MHz	(-0.5/+1 dB)	(-0.5/+1 dB)	(-0.5/+1 dB)	(-0.5/+1.5 dB)	(-0.5/+1.5 dB)	(-0.5/+1 dB)	(-0.5/+1.5 dB)	(-0.5/+1.5 dB)	(-0.5/+1 dB)	(-0.5/+1 dB)
	10 MHz to 230 MHz	(-0.5/+1.5 dB)	(-0.5/+3 dB)	(-0.5/+2.5 dB)	(-0.5/+2.5 dB)	(-0.5/+3.5 dB)	(-0.5/+4 dB)	(-0.5/+5 dB)	(-0.5/+3.5 dB)	(-0.5/+1 dB)	(-0.5/+2.5 dB)
ELECTRICAL											
Current (maximum continuous, per line)		25 Amperes					50 Amperes			100 Amperes	
Voltage (maximum)		250 Volts AC, 350 Volts DC (line to ground)									
RF Voltage (maximum)		40 Volts _{rms} (152 dBμV)									
INPUT/OUTPUT CONNECTORS											
EUT/AE Power Ports		4 mm shrouded banana sockets					5.2 mm banana socket with shrouded sheath			Multi-Contact ID/S6AR-N-B4S	
RF Port		50Ω - BNC-Type (female)									
DIMENSIONS AND WEIGHT											
Figure 1 - Dimension (A)		282 mm					355 mm	370 mm	392 mm	465 mm	
Figure 1 - Dimension (B)		332 mm					413 mm	428 mm	450 mm	525 mm	
Figure 1 - Dimension (C)		155 mm					179 mm				
Figure 1 - Dimension (D)		155 mm					168 mm				
Figure 1 - Dimension (E)		166 mm					179 mm				
Figure 1 - Dimension (F)		30 mm					40 mm				
Figure 1 - Dimension (G)		100 mm					100 mm				
Figure 1 - Dimension (H)		100 mm					118 mm				
Figure 1 - Dimension (I)		75 mm					89 mm			82 mm	
Weight (lbs./kg)		4.5 / 2	5.5 / 2.5	5.5 / 2.5	5.5 / 2.5	6 / 2.7	7 / 3.2	7.5 / 3.4	8 / 3.6	12.5 / 5.7	13 / 5.9

All values are typical, unless specified.
All specifications are subject to change without notice.

Figure 1 - Product Dimensions

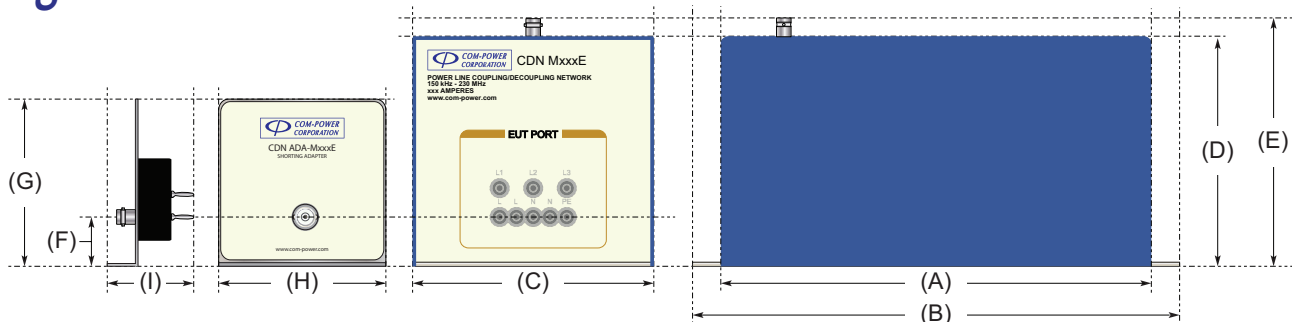

Rev. D06.18

Typical Impedance Data

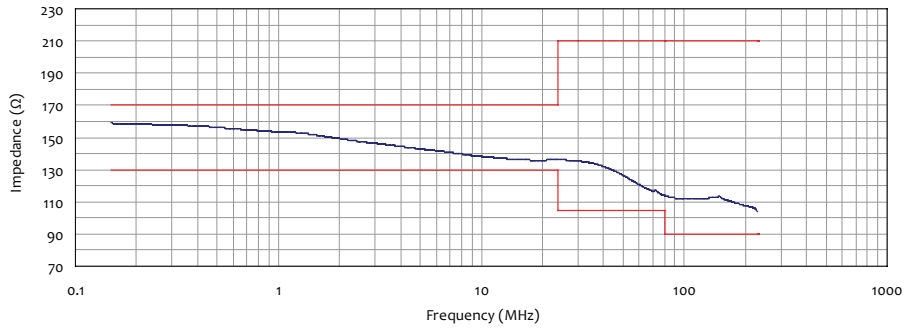

Typical Phase Data

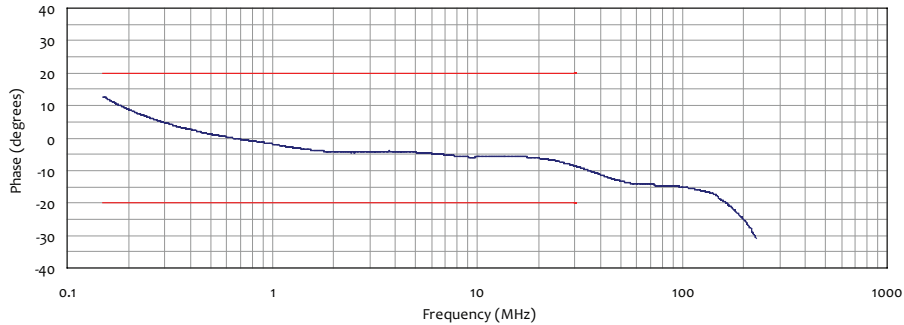

Typical Voltage Division Factor (VDF) Data

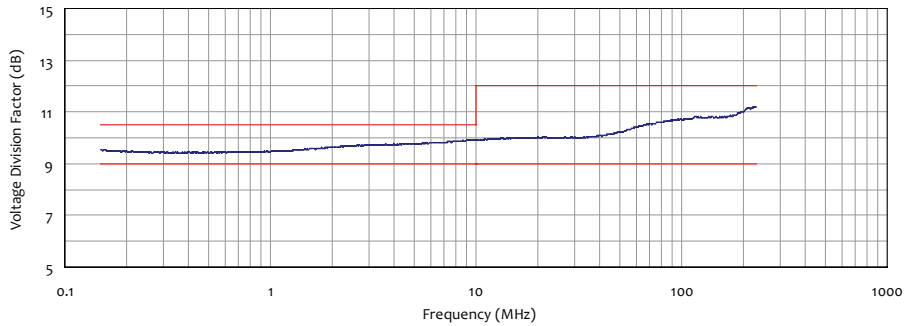

Typical Isolation (Decoupling Attenuation) Data

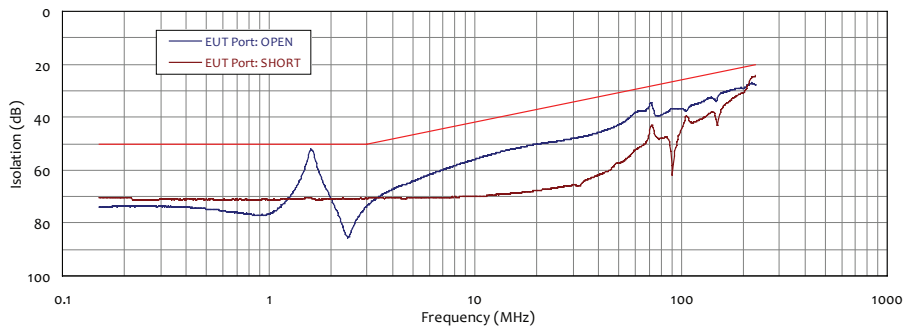

Data shown on above graphs is representative of a typical CDN M325E Coupling/Decoupling Network.