

Keysight E5063A ENA Series PCB Analyzer

Technical Overview

The best solution for PCB manufacturing test

- More accuracy and R&R
- More languages supported
- More ESD robustness

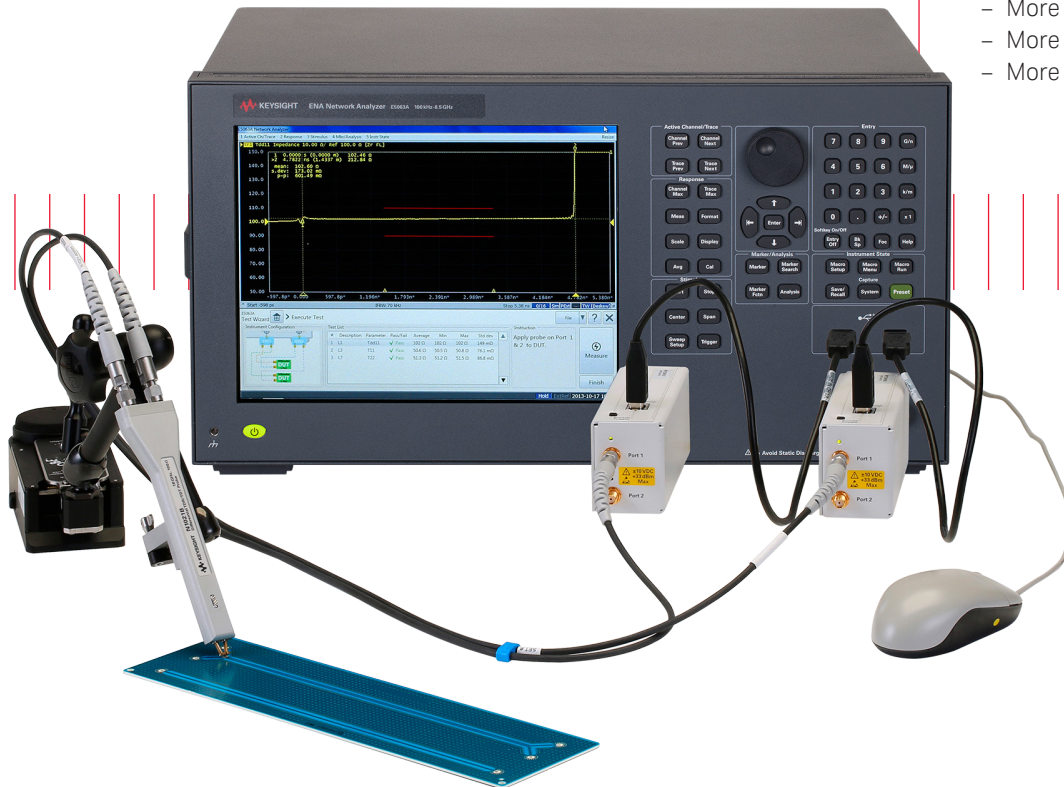

Why Choose the E5063A PCB Analyzer for Your Toughest Printed Circuit Board Measurement Challenges?

As the operating speed of electronic circuits increase, signal integrity of printed circuit boards (PCBs) drastically affect performance and there is an increasing requirement for controlled impedance PCBs. In addition, with the proliferation of wireless devices, such as smartphones and tablets, there is a trend to integrate antennas onto PCBs. Therefore, in addition to the traditional time domain impedance measurement, there is a growing need to measure the frequency domain response of PCB integrated antennas.



The E5063A PCB Analyzer consists of a E5063A ENA Vector Network Analyzer with Option 011 (Time domain analysis/ Test Wizard). The E5063A provides frequency domain measurement capability and Option 011 adds time domain analysis capability, as well as a dedicated graphical user interface for PCB manufacturing test.

The number of available ports can be expanded up to four with the addition of U1810B USB coaxial switches, to allow for simultaneous connection to both single-ended and differential probes.

Speed, accuracy and ease-of-use you need to ramp up rapidly and optimize PCB manufacturing test.

The E5063A PCB Analyzer changes the world of PCB measurements.

Key features and benefits

- Up to 18 GHz of bandwidth with 24.8 ps rise time enables measurement on the latest PCB designs
- Unmatched performance
 - Wide dynamic range to observe the true performance of your DUT: > 100 dB (at 4.5 GHz)
 - Low noise floor for accurate and repeatable measurements: 75 μ Vrms
 - Fast measurement speed for real-time analysis: 154 msec (at 1601 points with full 2-port calibration performed)
- State-of-the art error correction techniques reduce measurement errors
 - Automatic deskew ensures easy removal of fixture and probe effects
 - Full calibration (ECal) available for the utmost in measurement accuracy
- Upgrade all available ENA hardware and software options at any time. Buy what you need today and protect your investment by upgrading later when requirements change.

E5063A ENA Series PCB Analyzer the Best Solution for PCB Manufacturing Test

Three breakthroughs for PCB manufacturing test

Compared to traditional solutions based on TDR Oscilloscopes, the E5063A PCB Analyzer provides:

- More accuracy and R&R (Repeatability & Reproducibility)
- More languages supported
- More ESD robustness

More accuracy and R&R

Delivers new standards in accuracy

- Low noise floor for accurate and repeatable measurements
- State of the art error correction techniques enables you to measure your device, not your measurement system

More languages supported

An analyzer that speaks the user's language

- Since there are many cases where tasks are solved more efficiently in one's native language, a multi-lingual user interface is provided.
- Currently available languages include English, Simplified and Traditional Chinese, Japanese, and Korean

More ESD robustness

Protection circuits implemented inside the instrument

- Proprietary electrostatic discharge (ESD) protection chip significantly increases ESD robustness, while at the same time maintaining excellent RF performance
- Highly robust architecture can minimize instrument failure from ESD and free you from worrying about instrument repair fees and downtime

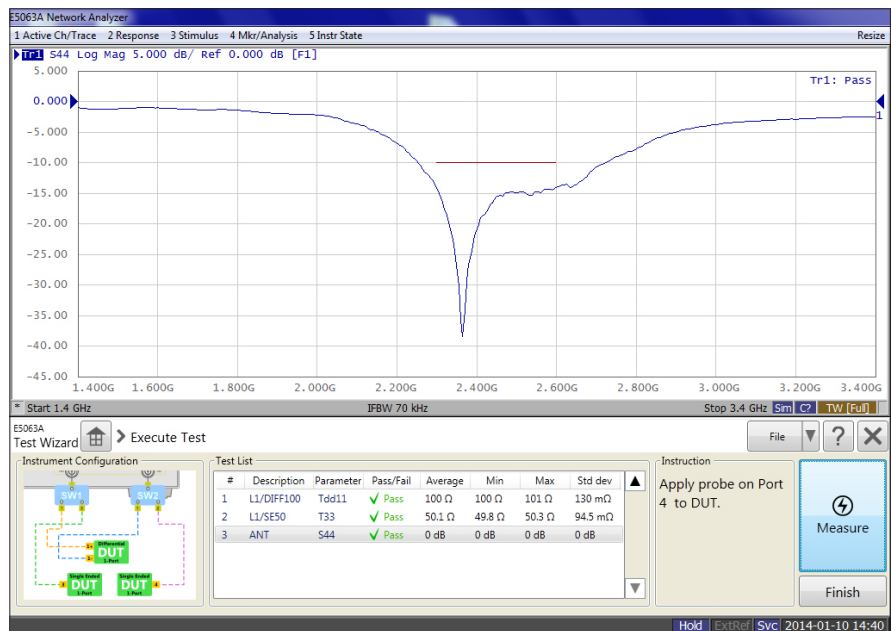

E5063A ENA Series PCB Analyzer the Best Solution for PCB Manufacturing Test

The PCB Analyzer user interface is designed specifically for measuring controlled impedance and return loss on PCBs. Providing a similar look-and-feel to traditional solutions, the PCB Analyzer is easy to setup and use without the need for extensive operator training.

Edit test mode

Test files are easily created and modified via the integrated test file editor. Most files can be created with just a few mouse clicks. Test files provide a convenient method for automated testing of boards with a number of different controlled impedance traces.

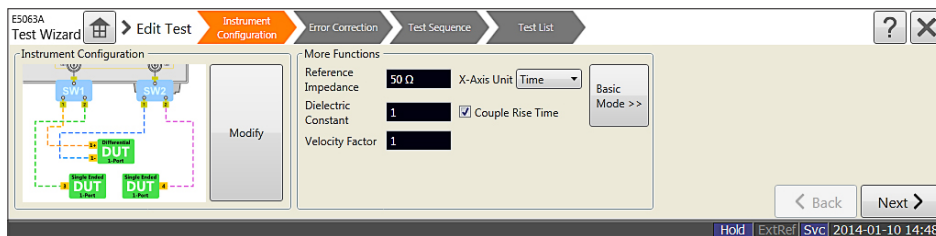

Execute test mode

Simple and intuitive user interface for non-technical operators. All the information necessary for performing measurements is stored in a test file. An operator only needs to select the appropriate test file from a list and the system is ready for testing.

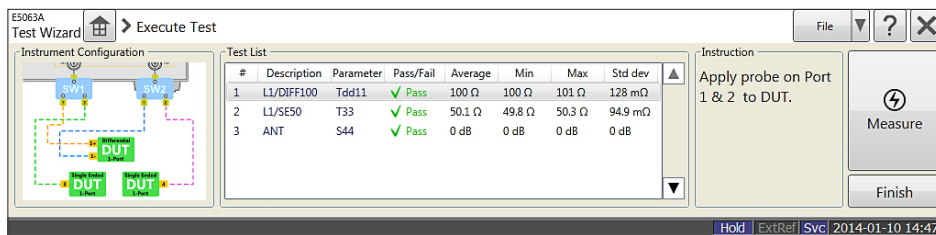

E5063A ENA Series PCB Analyzer the Best Solution for PCB Manufacturing Test

Wizards

Setup and Error Correction Wizards allows for intuitive and error free setup, error correction, and measurements.

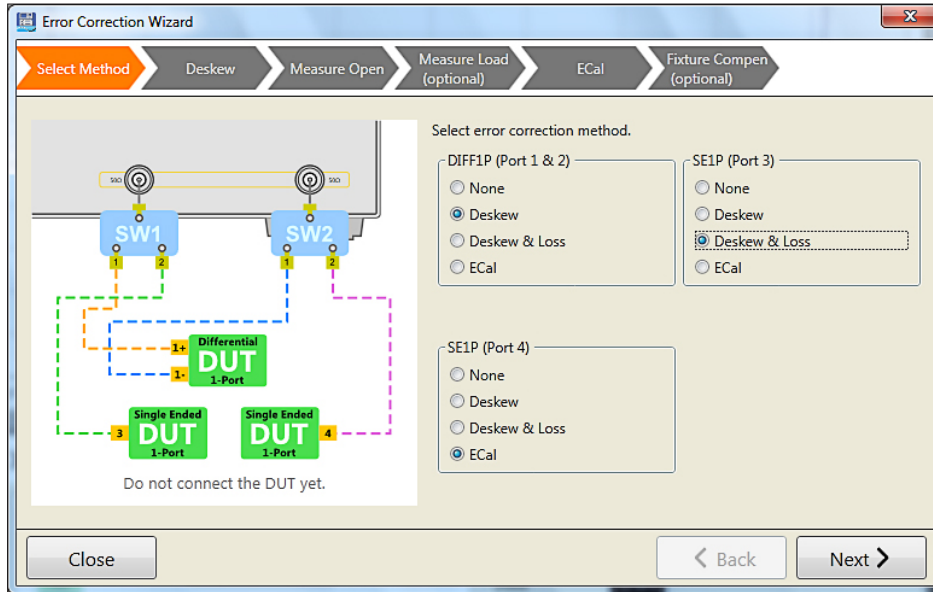

Dedicated controls for common adjustments

- The vertical and horizontal scales can be optimized by using the software knobs. In addition, the horizontal units can be set to display either time or distance (English or metric units).
- The DUT Length Wizard automatically measures the DUT length. The DUT length setting is used to set the optimum time span for measurements. After the time span is set, the test limits can be defined as a percentage of the trace length. Absolute, average, or multi-segment limit types are available.

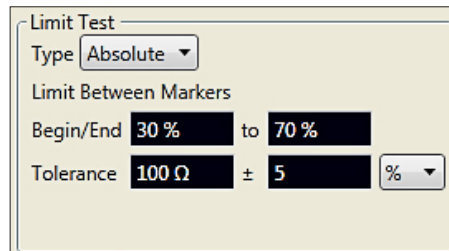
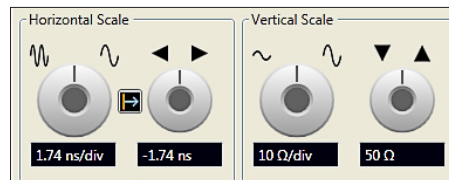

Three Breakthroughs for PCB Manufacturing Test

More accuracy and R&R

Accurate, repeatable, and reproducible measurements are important to ensure measurement correlation between the OEM and fabricator, as well as increasing yield.

There are two main considerations: absolute accuracy of measurement and measurement R&R (Repeatability and Reproducibility).

A number of factors can influence accuracy and R&R: cables, fixtures and probes, test equipment and operators.

Error correction is a powerful technique to remove systematic errors due to the cables, fixtures and probes, and test equipment.

State of the art error correction techniques reduce measurement errors and allows the PCB Analyzer to deliver new standards in accuracy required for the latest generation of products.

If there is no measurement error, one can distinguish between good and bad products with confidence.

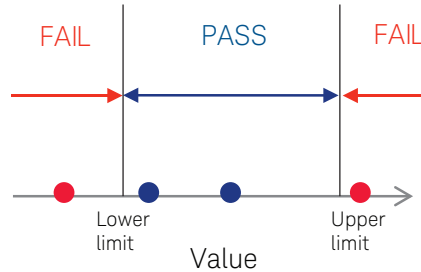

If there is measurement error, one may be left in doubt about the acceptability of the product.

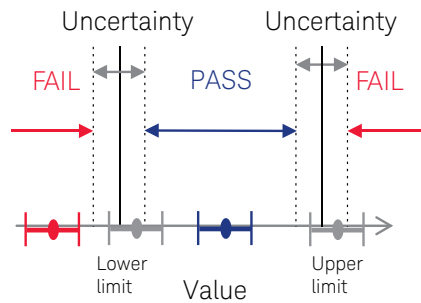

Guard bands are often used to account for measurement error, but results in lower yield.

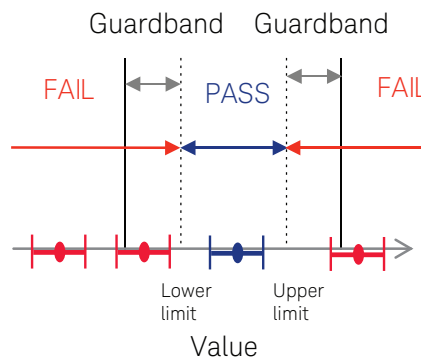

Three Breakthroughs for PCB Manufacturing Test

Error correction

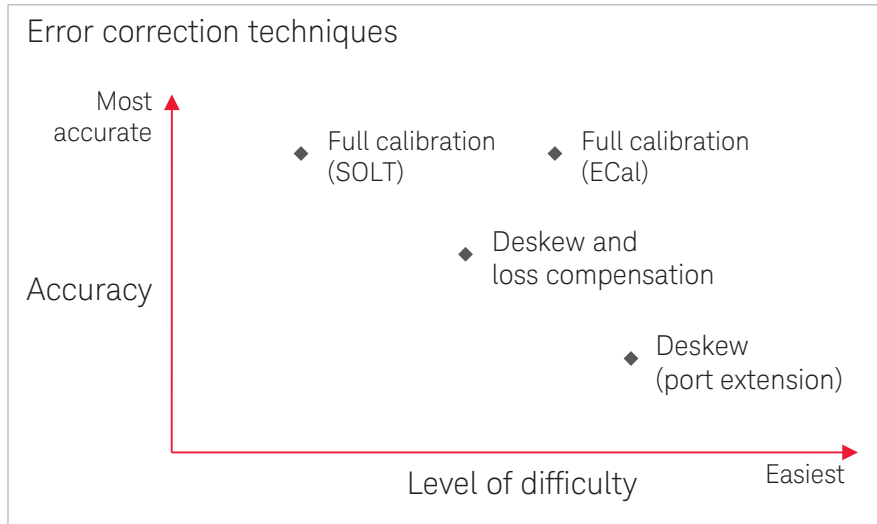

Choose your level of accuracy – trade off between complexity and accuracy

Over the years, many different approaches have been developed for removing the effects of the test fixture and probes from the measurement. The level of difficulty for each error correction technique is related to the accuracy of each method. It is important to have a test system that will allow flexibility of choosing the method of error correction desired for each application.

- **Deskew** (also known as Port Extension) mathematically extends the calibration reference plane to the DUT, effectively removing the delay from the test setup. This technique is easy to use, but assumes the probe and fixture – the unwanted structure – looks like a perfect transmission line: a flat magnitude response, a linear phase response, and constant impedance. If the probe and fixture are very well designed, this technique can provide good results.
- **Deskew and loss compensation** mathematically extends the calibration reference plane to the DUT, effectively removing the delay and loss from the test setup. This technique is a good compromise between level of difficulty and accuracy.
- **Full calibration (SOLT)** is one of the most comprehensive calibrations. This calibration effectively removes delay, loss, and mismatch from the test setup, making it possible to perform measurements with the highest possible accuracy.
- **Electronic calibration (Ecal)** is a complete solid-state calibration solution which makes full calibration fast and easy. Traditional mechanical calibrations require intensive operator interaction which is prone to errors. With ECal, the operator simply connects the ECal module to the instrument and the software controls the rest.

Three Breakthroughs for PCB Manufacturing Test

More languages supported



Since there are many cases where tasks are solved more efficiently in one's native language, a multi-lingual user interface is provided.

Currently available languages include English, Simplified and Traditional Chinese, Japanese, and Korean.

More ESD robustness

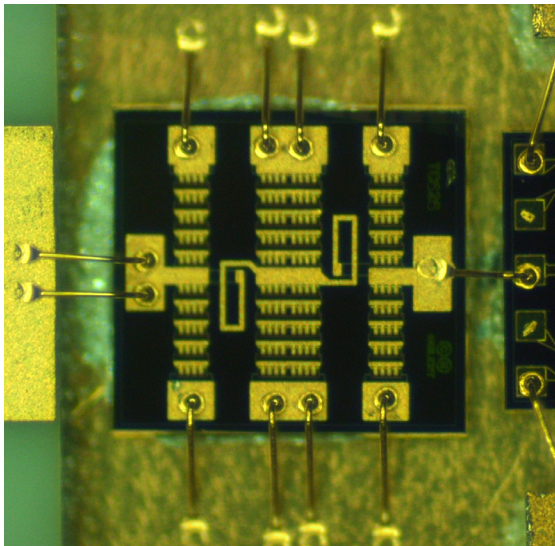

In applications such as PCB testing, large static charges can be stored in the DUT.

Special care is required when using traditional instruments in such situations, to make sure that the instrument is not damaged by electrostatic discharge (ESD). Vulnerability to ESD can lead to increased maintenance fees and long repair times.

The E5063A PCB Analyzer is designed for high robustness against ESD by implementing protection circuits inside the instrument.

Leveraging the company's expertise in RF design, Keysight Technologies, Inc. has invested in key technology blocks like our proprietary ESD protection chip to significantly increase ESD robustness, while at the same time maintaining excellent RF performance.

ESD survival IEC 801-2 Human Body Model. (150 pF, 330 Ω) RF Output Center pins tested to 3 kV, 10 cycles

Key Specifications

Definitions

- Specification (spec.): Warranted performance. All specifications apply at 23 °C (± 5 °C), unless otherwise stated, and 90 minutes after the instrument has been turned on. Specifications include guard bands to account for the expected statistical performance distribution, measurement uncertainties, and changes in performance due to environmental conditions.
- Typical (typ.): Expected performance of an average unit which does not include guardbands. It is not covered by the product warranty.
- General characteristics (char.): A general, descriptive term that does not imply a level of performance.

Test set option		Option 2H5	Option 285	Option 245
Bandwidth	spec.	18 GHz	8.5 GHz	4.5 GHz
Input connector	char.		Type-N (female)	
Input impedance	char.		50 Ω nominal	
Maximum non-destruct voltage	typ.		± 35 VDC	
TDR stimulus ¹	char.		Step	
TDR step rise time (10% to 90%) (min) ²	spec.	24.8 ps	52.4 ps	99.1 ps
TDR step response resolution in free space ($\epsilon_r = 1$) (min) ³	char.	7.4 mm	15.8 mm	29.7 mm
TDR deskew range (Test Cable Length) (max) ⁴	spec.		50 ns	
DUT length (max) ⁵	spec.		1.25 μ s	
TDR stimulus repetition rate (max)	spec.	18 MHz	8.5 MHz	4.5 MHz
RMS noise level ⁶	typ.		75 μ Vrms	

1. The time domain function of the PCB Analyzer is similar to the time domain reflectometry (TDR) measurement on a TDR oscilloscope in that it displays the response in the time domain. In the TDR oscilloscope measurement, a pulse or step stimulus is input to the DUT and the change of the reflected wave over time is measured. In the PCB Analyzer measurement, a sine wave stimulus is input to the DUT and the change of the reflected wave over frequency is measured. Then, the frequency domain response is transformed to the time domain using the inverse Fourier transform.
2. Minimum values may be limited by the DUT length setting.
3. To convert from rise time to response resolution, multiply the rise time by c , the speed of light in free space. To calculate the actual physical length, multiply this value in free space by v_f , the relative velocity of propagation in the transmission medium. Most cables have a relative velocity of 0.66 for a polyethylene dielectric or 0.7 for a PTFE dielectric.
4. Using high quality cables and probes to connect to the DUT is recommended in order to minimize measurement degradation. The cables should have low loss, low reflections, and minimum performance variation when flexed.
5. Maximum DUT length is the sum of the DUT and test cable lengths. To convert from DUT length in seconds to distance in free space, multiply the value in time by c , the speed of light in free space. To calculate the actual physical length, multiply this value in free space by v_f , the relative velocity of propagation in the transmission medium. Most cables have a relative velocity of 0.66 for a polyethylene dielectric or 0.7 for a PTFE dielectric.
6. RMS noise level with 50 Ω DUT and default setup.

For more details, refer to the *E5063A ENA Vector Network Analyzer*, Data Sheet
<http://literature.cdn.keysight.com/litweb/pdf/5991-3615EN.pdf>

Ordering Information

Step 1: Select frequency range

Option	Description
E5063A-205	2-port test set, 100 kHz to 500 MHz
E5063A-215	2-port test set, 100 kHz to 1.5 GHz
E5063A-235	2-port test set, 100 kHz to 3 GHz
E5063A-245	2-port test set, 100 kHz to 4.5 GHz
E5063A-265	2-port test set, 100 kHz to 6.5 GHz
E5063A-285	2-port test set, 100 kHz to 8.5 GHz
E5063A-2D5	2-port test set, 100 kHz to 14 GHz
E5063A-2H5	2-port test set, 100 kHz to 18 GHz

Step 2: Choose additional option (mandatory)

Option	Description
E5063A-010	Time domain analysis
E5063A-011	Time domain analysis/test wizard

Step 3: Choose accessories (optional)

Product	Description
U1810B	USB Coaxial Switch, DC to 18 GHz, SPDT
85092C	ECal module, 2-port, 300 kHz to 9 GHz, Type-N
85093C	ECal module, 2-port, 300 kHz to 9 GHz, 3.5 mm
N4690C	ECal module, 2-port, 300 kHz to 18 GHz, Type-N
N4691B	ECal module, 2-port, 300 kHz to 26.5 GHz, 3.5 mm
N4431B	ECal module, 4-port, 300 kHz to 13.5 GHz, 3.5 mm or Type-N
N4432A	ECal module, 4-port, 300 kHz to 18 GHz, Type-N
N4433A	ECal module, 4-port, 300 kHz to 20 GHz, 3.5 mm
N7550A ¹	Economy ECal module, 2-port, DC to 4 GHz, 3.5 mm or Type-N
N7551A ¹	Economy ECal module, 2-port, DC to 6.5 GHz, 3.5 mm or Type-N
N7552A ¹	Economy ECal module, 2-port, DC to 9 GHz, 3.5 mm or Type-N
N7553A ¹	Economy ECal module, 2-port, DC to 14 GHz, 3.5 mm or Type-N
N7554A ¹	Economy ECal module, 2-port, DC to 18 GHz, 3.5 mm or Type-N

Upgrade Options

E5063A offers full upgrade path from any low frequency options to any higher frequency options. The E5063A-010 and E5063A-011 Time domain analysis option upgrades are also upgradeable. Refer to the *E5063A Vector Network Analyzer* configuration guide [5991-3616EN](#) for more details.

1. The E5063A must have the firmware revision A.03.72 or above for the operation with the N755xA Series ECal modules.

Typical System Configuration

Single-ended and differential probing, 18 GHz system
(any third party TDR passive probe can be used with the PCB Analyzer)

Qty	Option/product	Description
1	E5063A-2H5	2-port test set, 100 kHz to 18 GHz
1	E5063A-011	Time Domain Analysis/Test Wizard
1	U1810B	USB coaxial switch, DC to 18 GHz, SPDT
1	N4433A	ECal module, 300 kHz to 20 GHz, 3.5 mm, 4-port

For more details, refer to the E5063A ENA Vector Network Analyzer configuration guide
<http://literature.cdn.keysight.com/litweb/pdf/5991-3616EN.pdf>

Web Resources

E5063A ENA Series PCB Analyzer
www.keysight.com/find/ena-pcb

ENA Vector Network Analyzers
www.keysight.com/find/ena

ENA Vector Network Analyzer Service and Support
www.keysight.com/find/ena_support

Electronic Calibration (ECal) Modules
www.keysight.com/find/ecal

Related Literature

E5063A ENA Vector Network Analyzer, Brochure
<http://literature.cdn.keysight.com/litweb/pdf/5991-3614EN.pdf>

E5063A ENA Vector Network Analyzer, Data Sheet
<http://literature.cdn.keysight.com/litweb/pdf/5991-3615EN.pdf>

E5063A ENA Vector Network Analyzer, Configuration Guide
<http://literature.cdn.keysight.com/litweb/pdf/5991-3616EN.pdf>

Network Analyzer Selection Guide
<http://literature.cdn.keysight.com/litweb/pdf/5989-7603EN.pdf>

Evolving Since 1939

Our unique combination of hardware, software, services, and people can help you reach your next breakthrough. We are unlocking the future of technology.

From Hewlett-Packard to Agilent to Keysight.

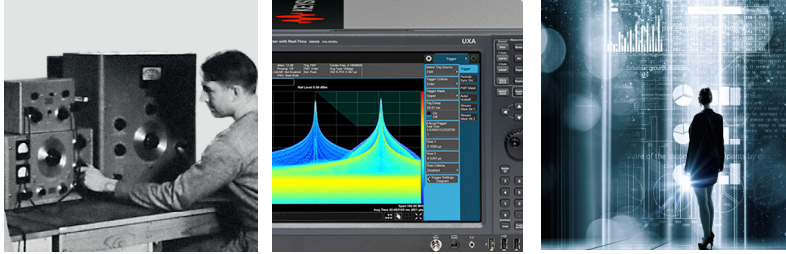

For more information on Keysight Technologies' products, applications or services, please contact your local Keysight office. The complete list is available at: www.keysight.com/find/contactus

Americas

Canada	(877) 894 4414
Brazil	55 11 3351 7010
Mexico	001 800 254 2440
United States	(800) 829 4444

Asia Pacific

Australia	1 800 629 485
China	800 810 0189
Hong Kong	800 938 693
India	1 800 11 2626
Japan	0120 (421) 345
Korea	080 769 0800
Malaysia	1 800 888 848
Singapore	1 800 375 8100
Taiwan	0800 047 866
Other AP Countries	(65) 6375 8100

Europe & Middle East

Austria	0800 001122
Belgium	0800 58580
Finland	0800 523252
France	0805 980333
Germany	0800 6270999
Ireland	1800 832700
Israel	1 809 343051
Italy	800 599100
Luxembourg	+32 800 58580
Netherlands	0800 0233200
Russia	8800 5009286
Spain	800 000154
Sweden	0200 882255
Switzerland	0800 805353
	Opt. 1 (DE)
	Opt. 2 (FR)
	Opt. 3 (IT)
United Kingdom	0800 0260637

For other unlisted countries:

www.keysight.com/find/contactus
(BP-9-7-17)

DEKRA Certified
ISO 9001 Quality Management System

www.keysight.com/go/quality
Keysight Technologies, Inc.
DEKRA Certified ISO 9001:2015
Quality Management System

myKeysight

myKeysight

www.keysight.com/find/mykeysight

A personalized view into the information most relevant to you.

http://www.keysight.com/find/emt_product_registration

Register your products to get up-to-date product information and find warranty information.

KEYSIGHT SERVICES
Accelerate Technology Adoption.
Lower costs.

Keysight Services

www.keysight.com/find/service

Keysight Services can help from acquisition to renewal across your instrument's lifecycle. Our comprehensive service offerings—one-stop calibration, repair, asset management, technology refresh, consulting, training and more—helps you improve product quality and lower costs.



Keysight Assurance Plans

www.keysight.com/find/AssurancePlans

Up to ten years of protection and no budgetary surprises to ensure your instruments are operating to specification, so you can rely on accurate measurements.

Keysight Channel Partners

www.keysight.com/find/channelpartners

Get the best of both worlds: Keysight's measurement expertise and product breadth, combined with channel partner convenience.

www.keysight.com/find/vna



This information is subject to change without notice.
© Keysight Technologies, 2013 - 2015, 2017, 2018
Published in USA, May 15, 2018
5991-3617EN
www.keysight.com